



Mikrotik Training Basic



Certified Mikrotik Training Basic Class

Organized by: Citraweb Nusa Infomedia

(Mikrotik Certified Training Partner)



Jadwal Training

	Session 1	Session 2	Session 3	Session 4
Hari 1	Introduction Pre-Test	TCP/IP Instalation	Basic Configuration	
Hari 2	Bridge	Wireless		Routing
Hari 3	Firewall		QOS	
Hari 4	Hotspot		VPN	Test



Jadwal Harian

- Sessi 1 08.30 – 10.00
- Coffee Break 10.00 – 10.30
- Sessi 2 10.30 - 12.00
- Lunch 12.00 – 13.00
- Sessi 3 13.00 – 14.30
- Coffee Break 14.30 – 15.00
- Sessi 4 15.00 - 17.00



New Training Scheme 2010

- **Basic/Essential Training**

- MikroTik Certified Network Associate (MTCNA)

- **Advanced Training**

- Certified Wireless Engineer (MTCWE)
- Certified Routing Engineer (MTCRE)
- Certified Traffic Control Engineer (MTCTCE)
- Certified User Managing Engineer (MTCUME)
- Certified Inter Networking Engineer (MTCINE)

Certification Test

- Diadakan oleh **Mikrotik.com** secara online
- Dilakukan pada sesi terakhir
- Jumlah soal : **25** Waktu: **60 menit**
- Nilai minimal kelulusan : **60%**
- Yang mendapatkan nilai **50%** hingga **59%** berkesempatan mengambil “***second chance***”
- Yang lulus akan mendapatkan sertifikat yang diakui secara internasional





Introduction to Mikrotik



Certified Mikrotik Training Basic Class

Organized by: Citraweb Nusa Infomedia

(Mikrotik Certified Training Partner)



Citraweb Nusa Infomedia

- Using Mikrotik since 2001, as Wireless ISP (Citra-Net)
- Mikrotik OEM Authorized Reseller (2002)
<http://www.mikrotik.com/1howtobuy.html>
- One engineer:
Mikrotik Certified Consultant (2005)
<http://www.mikrotik.com/consultants.html>
- Mikrotik Certified Training Partner (2005)
<http://www.mikrotik.com/training.php>



Citraweb Nusa Infomedia

- Head Office

- Jalan Petung 31 Papringan
Yogyakarta 55281
Telp: 0274-554444
Fax: 0274-553055

- Rep. Office

- Gd Cyber Lt 11
Jl Kuningan Barat 8 Jakarta 12710
Telp: 021-5209612
Fax: 021-5209614

What Is Mikrotik?

- Software Router untuk PC (x86, AMD, dll) → RouterOS
 - Menjadikan PC biasa memiliki fungsi router yang lengkap
 - Diinstall sebagai Operating System, tidak membutuhkan operating system lainnya
- Hardware untuk jaringan (terutama wireless)
 - Wireless board
contoh: RB400, RB600, RB750, RB1000
 - Wireless interface (R52, R52H, R5H, R52N, R2N)
 - menggunakan RouterOS sebagai software

What Is Mikrotik?

- Mikrotik adalah kependekan dari **mikrotikls**
- Artinya: “network kecil” dalam bahasa Latvia



Routerboard for Wireless

Jenis	Processor	RAM	Ether	MiniPCI	USB	Radio	Lisensi
RB800	MPC8544 800MHz	256MB	3 (gig)	4	-	-	6
RB435G	AR71xx 680MHz	256MB	3 (gig)	5	2	-	5
RB433UAH	AR71xx 680MHz	128MB	3	3	2	-	5
RB433/ AH	AR71xx 300/ 680MHz	64MB/ 128MB	3	3	-	-	4 / 5
RB411UAHR	AR71xx 680 MHz	64MB	1	1	1	1	4
RB411AH	AR71xx 680 MHz	64MB	1	1	-	-	4
RB411U/ AR	AR71xx 300 MHz	32MB/ 64MB	1	1	1 / -	- / 1	4
GrooveA-5Hn	AR72xx 400MHz	64MB	1	-	-	1	4
RB711A-5nH	AR72xx 400MHz	64MB	1	-	-	1	4
Groove-5Hn	AR72xx 400MHz	32MB	1	-	-	1	3
RB711-5nH	AR72xx 400MHz	32M	1	-	-	1	3

■ - For Client or Point to Point Connection

Routerboard for Indoor Router

Jenis	Processor	RAM	Ethernet	MiniPCI	Lisensi
RB1100AH X2	PPC 1Ghz dual Core	2GB	13 (gigabit)	0	6
RB1100AH	PPC 1Ghz	2GB	13 (gigabit)	0	6
RB1200	PPC 1Ghz	512MB	10 (gigabit)	0	6
RB493G	AR71xx 680 MHz	256MB	9 (gigabit)	3	5
RB493 / AH	AR71xx 300 / 680 MHz	64MB / 128MB	9	3	4 / 5
RB450G	AR71xx 680 MHz	256MB	5 (gigabit)	0	5
RB450	AR71xx 300 MHz	32MB	5	0	5
RB750	AR72xx 400MHz	32MB	5	0	4
RB750GL	AR72xx 400MHz	64MB	5 (gigabit)	0	4

Discontinued Hardware

- RB100 series
 - RB112, RB133, RB133C
 - RB153, RB150, RB192
- RB200 series
 - RB230
- RB300 series
 - RB333
- RB400 series
 - RB411A, RB411R
- RB500 series
 - RB532, RB511
- RB600 series
 - RB600
- RB700 series
 - RB750G
- RB1000 series
 - RB1000, RB1100



RB1100AH / X2

- 13 Port Gigabit ethernet
- 1GHz Network Processor / Dual Core
- RAM: 2GB
- up to:
 - 2 Gbps
 - 250.000 pps / 1M pps
- 1U rackmount
- Bypass Function

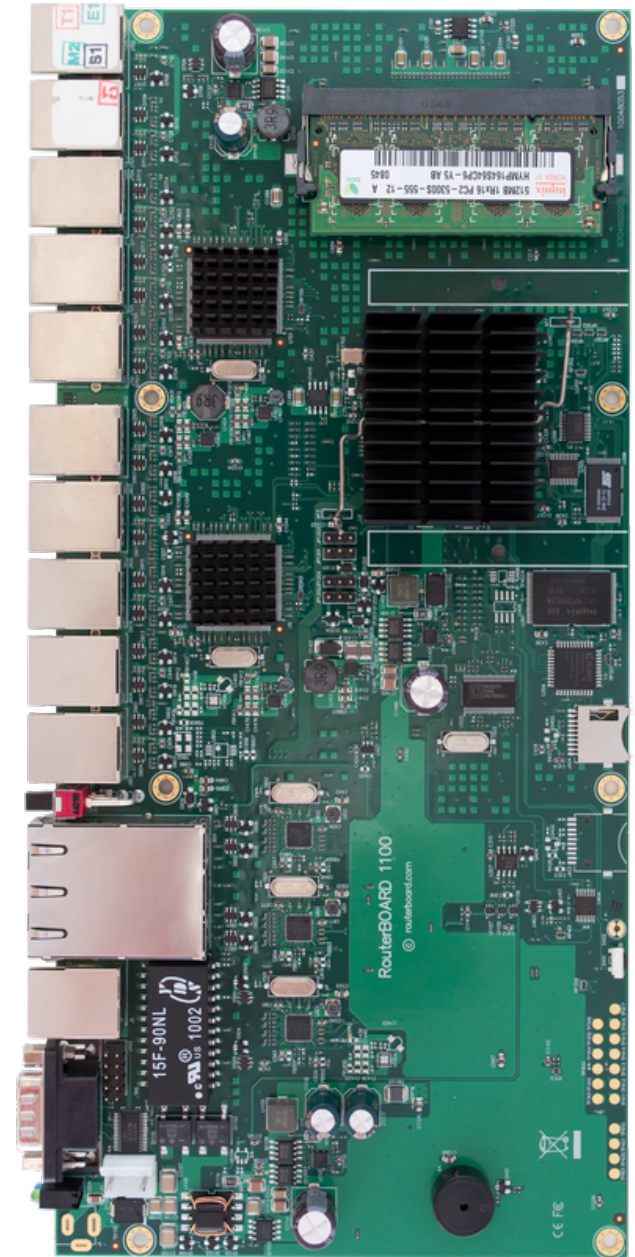

RB800

- 3 Gigabit Ethernet
- 4 Minipci Slot
- DaughterBoard Expandable
- CF slot
- MPC8544 800MHz CPU
- 256 DDR SDRAM

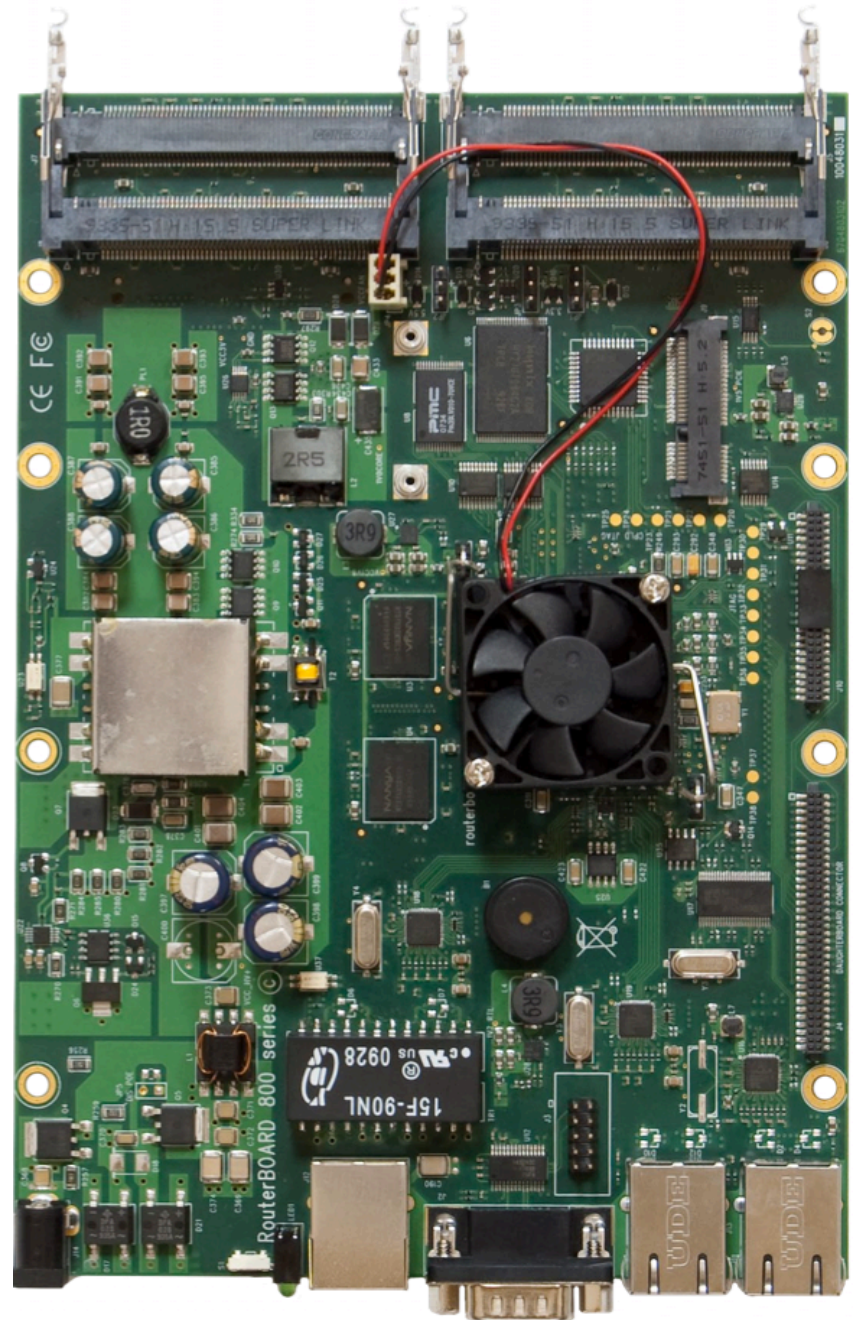

RB433UAH

- 3 Ethernet, 3 Minipci
- Atheros AR7161 680MHz
- RAM: 128MB
- With micro-SD slot
- RouterOS Level 5
- 2 port USB

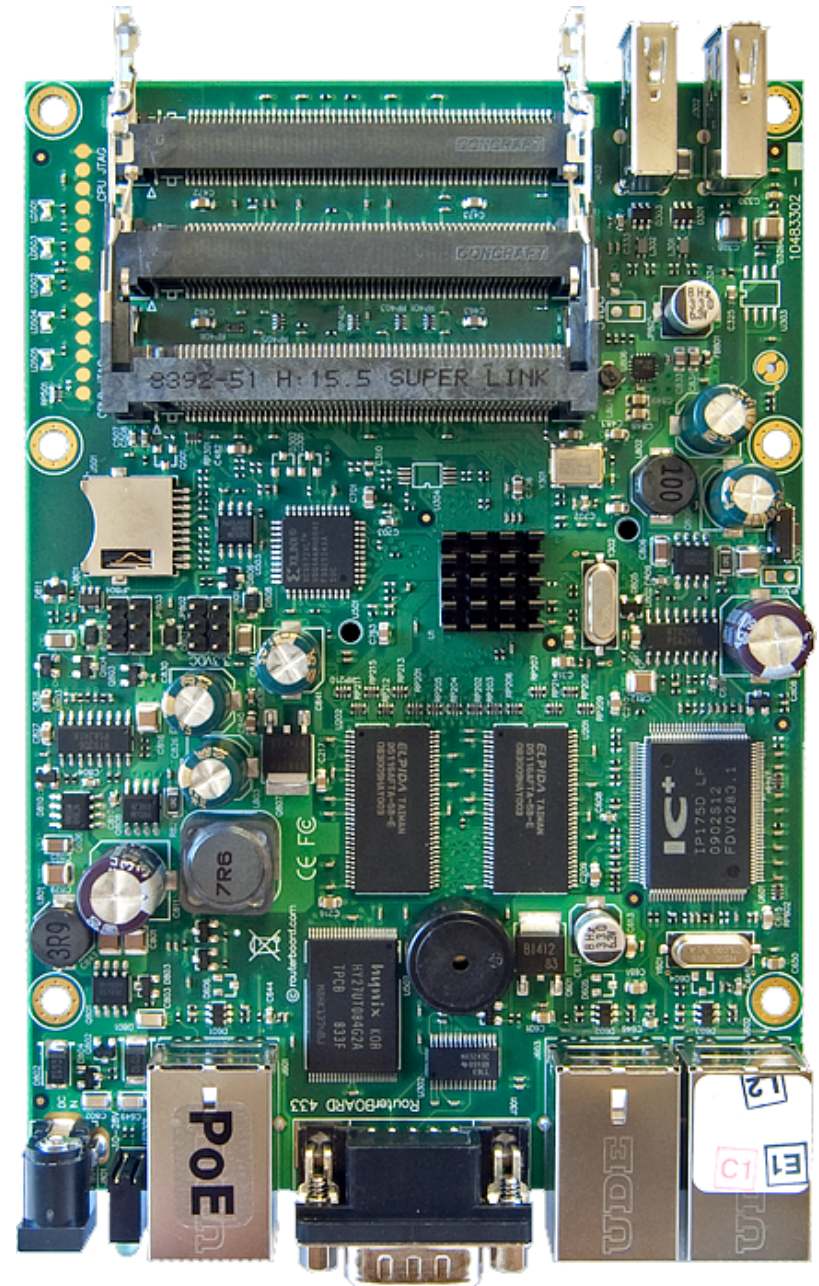
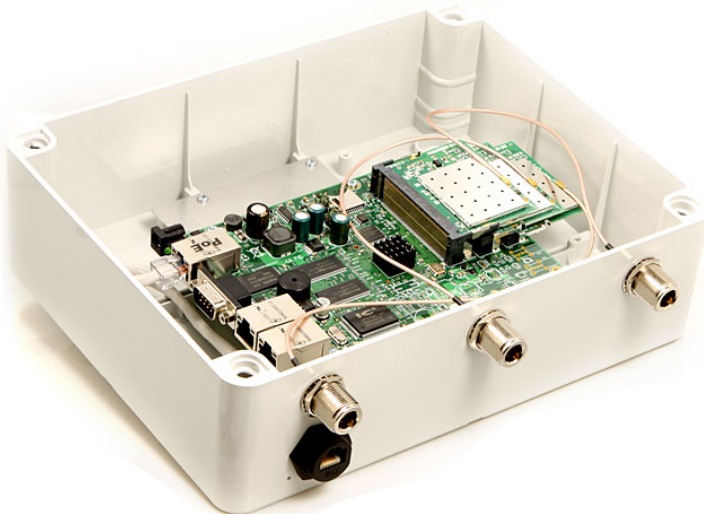

RB411 / U / AR / AH / UAHR

- CPU: Atheros
 - AR7130 300MHz (411/U/AR)
 - AR7161 680 MHz (411AH/UAHR)
- Memory:
 - 32 MB (411/U)
 - 64MB (411AR/UAHR/AH)
- Wireless Embedded (411AR/UAHR)
- 1 ethernet
- 1 MiniPCI (411/U/AR/AH/UAHR)
- Lisensi RouterOS:
 - Level 3 (411)
 - Level 4 (411U/AR/AH/UAHR)

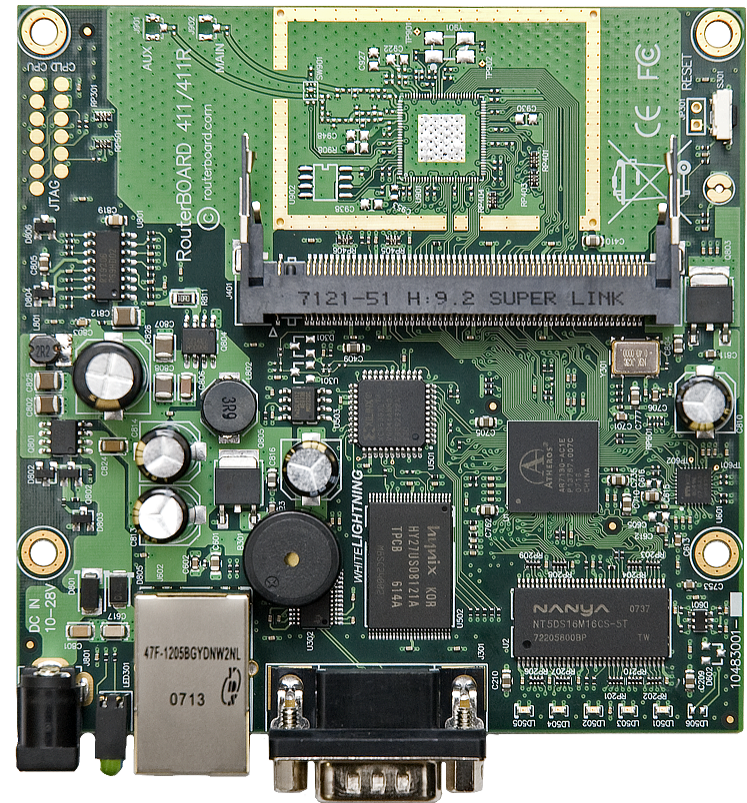

RB493/AH/G

- 9 ethernet (gigabit di 493G)
- 3 Minipci Slot
- Processor :
 - Atheros AR7161 680MHz (493AH & G)
 - Atheros AR7130 300MHz (493)
- RAM: 64MB
- RouterOS:
 - Level 4 (RB493)
 - Level 5 (RB493AH & G)

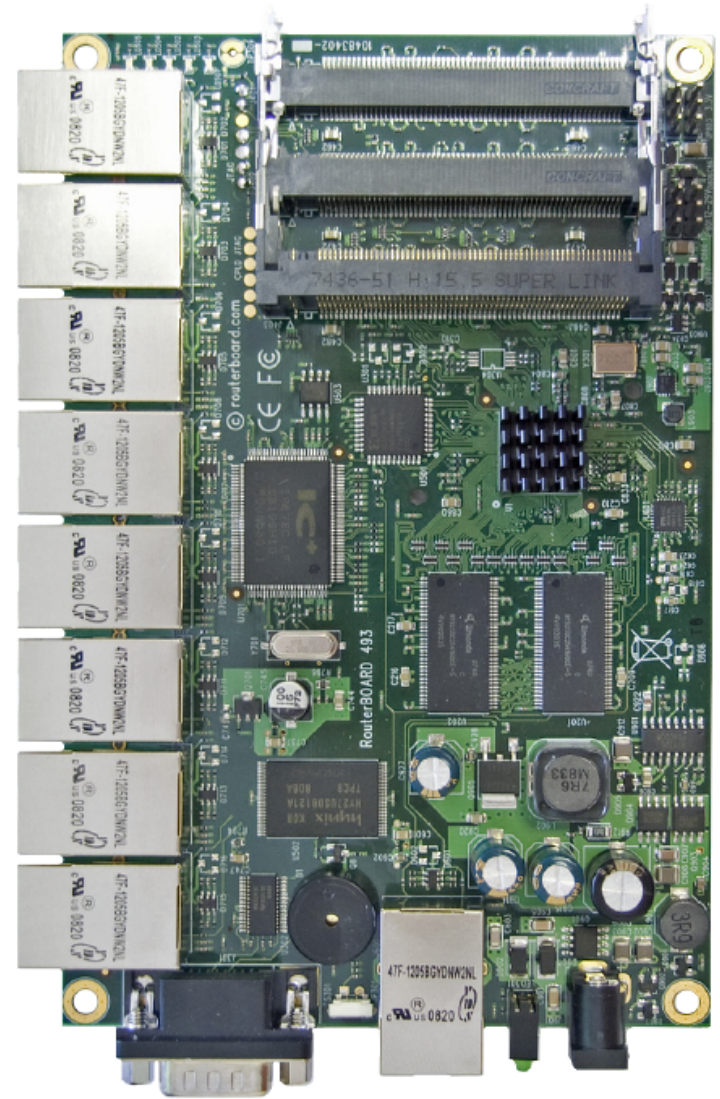

● ● ● | Embedded Solution

- Embedded Antenna 2,4GHz & 5GHz
- With Routerboard 411 series / 711 Series



NEW
PRODUCT

RB450 / G

- 5 port Ethernet / gigabit
- Tanpa minipci port
- Processor : Atheros
300MHz / 680 MHz
- RAM: 64 / 256 MB
- RouterOS Level 5



● ● ● | RB750 / GL

- Produk routerboard terhemat dan terkecil
- Processor : AR7240 400Mhz
- 5 ethernet port (750)
5 gigabit port (750GL)
- Lisensi Level 4



● ● ● | RB751U-2HND

- High power 1W 802.11b/g/n wireless AP
- 5 Port Ethernet
- 1 Port USB
 - For Modem
 - For Flashdisk
- 2x2 MIMO Integrated Antenna

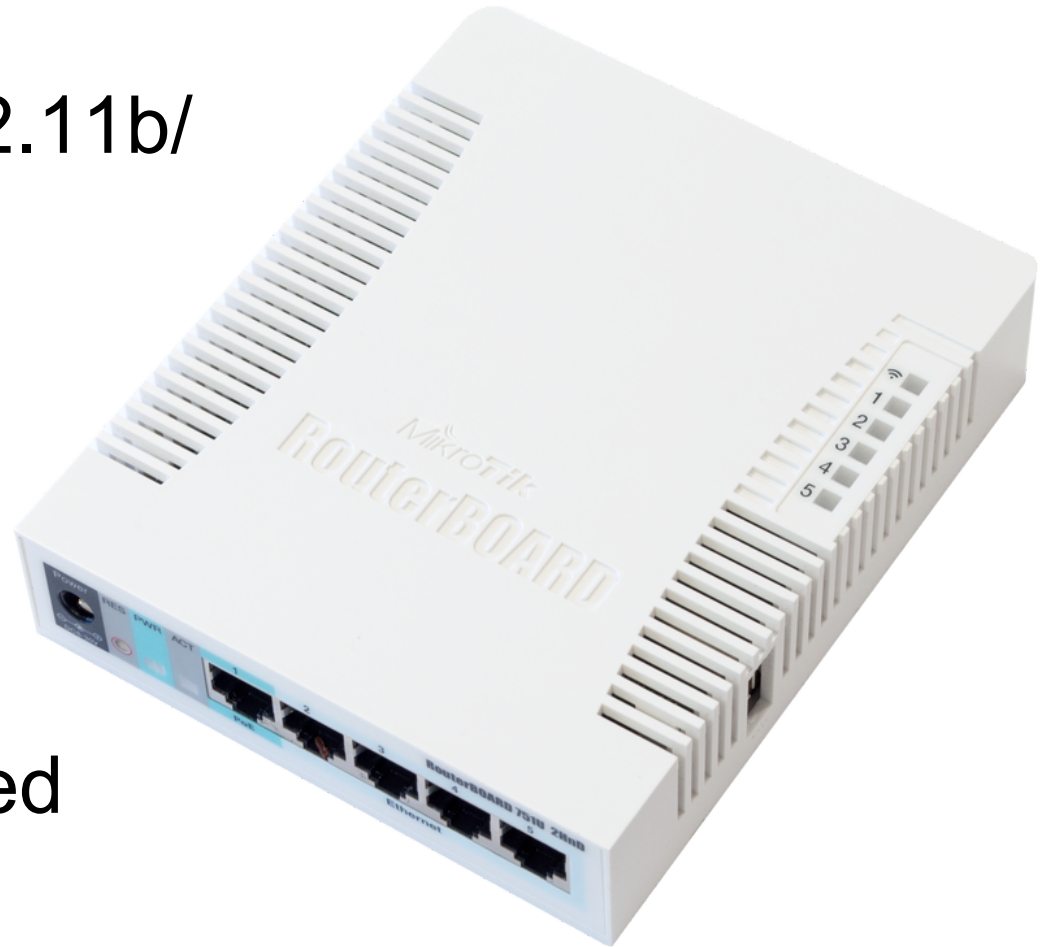

Wireless Interface

- R52/H (a/b/g)
 - Atheros chipset
 - MiniPCI type interface
 - 65 mWatt / **350 mWatt**
 - 3 band wireless
 - 2.4 GHz, 5.2 GHz, 5.8 GHz
 - Custom Frequency Support
 - 2.1 – 2.5 GHz
 - 4.9 – 6.0 GHz

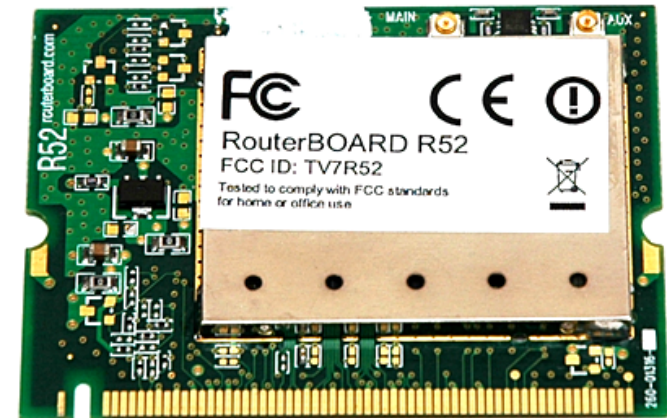
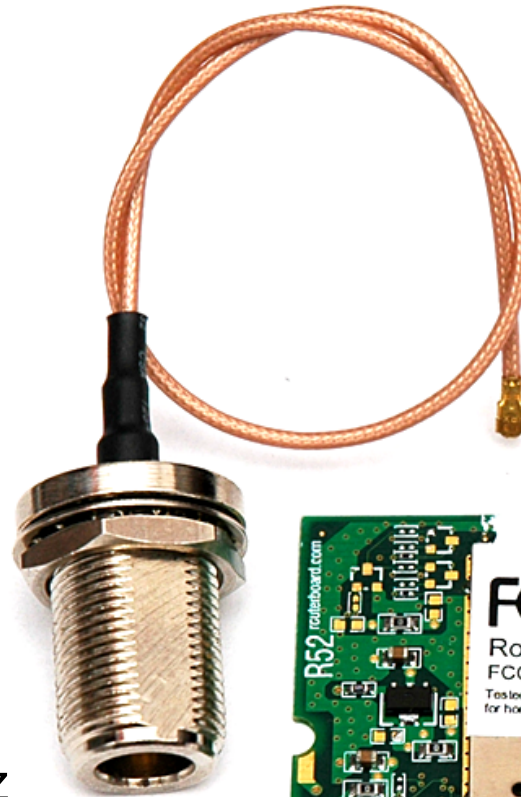

R52N (a/b/g/n)

NEW
PRODUCT

- Dual band IEEE 802.11a/b/g/n standard
- Output Power of up to 25dBm @ b/g/n Band
- Support for up to 2x2 MIMO with spatial multiplexing
- Four times the throughput of 802.11a/g
- Atheros AR9220, chipset
- 2 X U.FL Antenna Connector
- Operating temperatures: 0°C to 60°C
- Power consumption MAX 2.4W
- Modulations: OFMD: BPSK, QPSK, 16 QAM, 64QAM DSSS: DBPSK, DQPSK, CCK
- High Performance (up to 300Mbps physical data rates and 200Mbps of actual user throughput) with Low Power Consumption
- ESD protection agaist +/-10kV ESD discharge on Antenna port



Wireless N - Performance

The screenshot displays the Mikrotik WinBox Bandwidth Test interface for interface wlan1. The configuration is as follows:

- Test To: 1.1.1.2
- Protocol: udp
- Local UDP Tx Size: 1500
- Remote UDP Tx Size: 1500
- Direction: both
- TCP Connection Count: 20
- Local Tx Speed: [empty] bps
- Remote Tx Speed: [empty] bps
- User: admin
- Password: [empty]
- Tx/Rx 10s Average: 89.5 Mbps/106.4 M...
- Tx/Rx Average: 71.2 Mbps/83.6 Mbps

The interface configuration for wlan1 is shown on the right:

- Wireless: HT
- HT Tx Chains: 0 (chain0) and 1 (chain1) are checked.
- HT Rx Chains: 0 (chain0) and 1 (chain1) are checked.
- HT AMSDU Limit: 8192
- HT AMSDU Threshold: 8192
- HT Guard Interval: any
- HT Extension Channel: below control

The AP Client <00:0C:42:61:22:DF> is selected, and the Statistics tab is active, showing the following performance metrics:

- Tx/Rx Rate: 270.0Mbps-HT/270.0Mbps-HT
- Tx/Rx Packets: 851 744/1 009 440
- Tx/Rx Bytes: 1229.5 MiB/1457.1 MiB
- Tx/Rx Frames: 851 529/1 009 192
- Tx/Rx Frame Bytes: 1229.5 MiB/1456.7 MiB

A real-time throughput graph at the bottom left shows Tx at 92.8 Mbps and Rx at 106.0 Mbps.

- Throughput: 195 ~ 200 Mbps

Mikrobits – Enterprise Router

- 7 / 11 Intel gigabit ethernet
- **Multi Core Processor**
- 1U rackmount
- 2 GB RAM
 - Industrial grade
- Performance :
 - **2-4 Gbps** full duplex (**Ainos**)
 - **3-5 Gbps** full duplex (**Celoica**)
- 9000 jumbo frame supported



Mikrobits – Fiber Optic Router

- **16** Intel gigabit ethernet
- **Xeon Multi Core Processor**
- 1U rackmount
- 2 GB RAM
 - Industrial grade
- Performance :
 - **6-8 Gbps** full duplex
- 9000 jumbo frame supported
- **4 SFP or 8 SFP**



Interface List

Interface	Ethernet	EoIP Tunnel	IP Tunnel	GRE Tunnel	VLAN	VRRP	Bonding					
<input type="button" value="+"/> <input type="button" value="-"/> <input type="button" value="✓"/> <input type="button" value="✗"/> <input type="button" value="📄"/> <input type="button" value="🔍"/> <input type="text" value="Find"/>												
Name	Type	L2 MTU	Tx	Rx	Tx Pac...	Rx Pac...	Tx Drops	Rx Drops	Tx Errors	Rx Errors		
R ether1	Ethernet		147.4 M...	160.5 M...	17 173	20 492	0	0	0	0		
R ether10	Ethernet		39.7 kbps	8.5 kbps	7	11	0	0	0	0		
R ether2	Ethernet		160.5 M...	147.3 M...	20 491	17 168	0	0	0	0		
R ether3	Ethernet		159.6 M...	159.3 M...	18 740	18 064	0	0	0	0		
R ether4	Ethernet		159.3 M...	159.6 M...	18 064	18 739	0	0	0	0		
R ether5	Ethernet		160.5 M...	159.1 M...	20 508	17 941	0	0	0	0		
R ether6	Ethernet		159.1 M...	160.5 M...	17 941	20 508	0	0	0	0		
R ether7	Ethernet		124.1 M...	87.3 Mbps	12 709	10 557	0	0	0	9		
R ether8	Ethernet		87.3 Mbps	124.1 M...	10 558	12 709	0	0	0	0		
R ether9	Ethernet		0 bps	0 bps	0	0	0	0	0	0		

Firewall

Filter Rules	NAT	Mangle	Service Ports	Connections	Address Lists	Layer7 Protocols					
<input type="button" value="-"/> <input type="button" value="🔍"/> <input type="button" value="Tracking"/> <input type="text" value="Find"/>											
Src. Address	Dst. Address	Prot...	Connecti...	Connecti...	P2P	Timeout	TCP St	CPU	Load (%)	IRQ (%)	Disk (%)
U 0.0.0.0:5678	255.255.255.255:5...	17 (...)				00:00:04		0	15	14	0
A 10.5.50.200:61097	172.16.1.1:8291	6 (tcp)	test			22:28:45	establi	1	20	20	0
A 10.5.50.200:61106	192.168.5.123:8291	6 (tcp)				01:25:56	establi	2	23	23	0
	172.16.1.1	1 (ic...	test			00:00:04		3	31	31	0
A 172.16.1.1:46943	172.16.11.1:2000	6 (tcp)	test			23:45:25	establi				
A 172.16.1.1:46944	172.16.11.1:2000	6 (tcp)	test								
A 172.16.1.1:46945	172.16.11.1:2000	6 (tcp)	test								
A 172.16.1.1:46946	172.16.11.1:2000	6 (tcp)	test								
A 172.16.1.1:46947	172.16.11.1:2000	6 (tcp)	test								
A 172.16.1.1:46948	172.16.11.1:2000	6 (tcp)	test								
A 172.16.1.1:46949	172.16.11.1:2000	6 (tcp)	test								
A 172.16.1.1:46950	172.16.11.1:2000	6 (tcp)	test								
A 172.16.1.1:46951	172.16.11.1:2000	6 (tcp)	test								
A 172.16.1.1:46952	172.16.11.1:2000	6 (tcp)	test								
A 172.16.1.1:46953	172.16.11.1:2000	6 (tcp)	test								
A 172.16.1.1:46954	172.16.11.1:2000	6 (tcp)	test								
A 172.16.1.1:46955	172.16.11.1:2000	6 (tcp)	test								
535 items			Max Entries: 524288								

Interface <ether1>

General | Ethernet | Status | Traffic

Name: ether1

Type: Ethernet

MTU: 1500

L2 MTU:

Max L2 MTU:

MAC Address: 00:60:E0:49:0C:ED

OK | Cancel | Apply | Disable | Comment | Torch

Mikrotik RouterOS

- RouterOS adalah sistem operasi dan perangkat lunak yang mampu membuat PC berbasis Intel/AMD mampu melakukan fungsi **Router, Bridge, Firewall, Bandwidth Management, Wireless AP & Client** dan masih banyak fungsi lainnya
- RouterOS dapat melakukan hampir semua fungsi networking dan juga beberapa fungsi server.

Fitur Mikrotik RouterOS (1)

- IP Routing
 - Static route & Policy route
 - Dynamic Routing (RIP, OSPF, BGP)
 - Multicast Routing
- Interface
 - Ethernet, V35, G703, ISDN, Dial Up Modem
 - Wireless : PTP, PTMP, Nstream, WDS, Mesh
 - Bridge, Bonding, STP, RSTP
 - Tunnel: EoIP, IPSec, IPIP, L2TP, PPPoE, PPTP, VLAN, MPLS, OpenVPN, SSTP
- Firewall
 - Mangle, NAT, Address List, Filter Rules, L7 protocol
- Bandwidth Management
 - HTB, PFIFO, BFIFO, SFQ, PCQ, RED

Fitur Mikrotik RouterOS (2)

- Services (Server)
 - Proxy (cache), Hotspot, DHCP, IP Pool, DNS, NTP, Radius Server (User-Manager)
- AAA
 - PPP, Radius Client
 - IP Accounting, Traffic Flow
- Monitoring
 - Graphs, Watchdog, Torch, Custom Log, SNMP, The Dude Monitoring Tools
- Diagnostic Tools & Scripting
 - Ping, TCP Ping, Tracert, Network Monitoring, Traffic Monitoring, Scheduler, Scripting
- VRRP

Licence Level

Level	3	4	5	6
Upgrade time	dalam 1 versi mayor dan versi berikutnya			
Wireless CPE/PTP	yes			
Wireless AP	no	yes		
Sync Interface	no	yes		
EoIP	1	unlimited		
PPPoE	1	200	500	unlimited
PPTP & L2TP	1	200	unlimited	
VLAN, Firewall, Queue	unlimited			
Proxy, Radius Client	yes			
Dynamic Routing	RB = yes	yes		
Hotspot Active User	1	200	500	unlimited
User Manager Active User	10	20	50	unlimited

- **Level 0 = Trial 24 Jam , Level 1 = Hanya bisa 1 rule di semua fitur**

● ● ● | Produk Mana Yang Dipilih

- Kenalilah kebutuhan Anda :
 - Fungsi perangkat (Router, Server dll)
 - Jumlah trafik (Real Troughput)
 - Fitur yang dibutuhkan (Proxy, Hotspot, Radius)
 - Interface yang dibutuhkan
- Baik menggunakan PC ataupun menggunakan Routerboard, fitur Mikrotik RouterOS selalu sama (tergantung pada level yang digunakan)



Buyer's Guide

- 300 / 400 Mhz Processor (< **5Mbps** Traffic)
 - *RB450, RB750, RB433, RB493*
- 680 Mhz Processor (**5 ~ 20 Mbps** Traffic)
 - *RB450G, RB433AH, RB493G*
- 1Ghz Processor (**20 ~ 100 Mbps** Traffic)
 - *RB1200, RB1100AH*
- 1Ghz Dual Core Processor (> **100 Mbps** Traffic)
 - *RB1100AHx2*
- Multi Core x86 Processor (> **1 Gbps** Traffic)
 - *Mikrobits : Aneto, Ainos, Dinara*
- Xeon Processor (> **10 Gbps** Traffic)
 - *Mikrobits : Dinara*



Mikrotik Installation



Certified Mikrotik Training Basic Class

Organized by: Citraweb Nusa Infomedia

(Mikrotik Certified Training Partner)

● ● ● | Instalasi Mikrotik

- Media Instalasi (Penyimpan) Mikrotik RouterOS
 - Harddisk
 - CF Disk
 - DOM (Disk On Module)
 - SATA DOM (coming soon on mikrotik.co.id)
 - USB Flash Disk
 - komputer harus bisa booting dari USB (setting BIOS)
 - Routerboard



Installation Method

○ **CD**

- Create CD from CD image (iso file)
- For PC Router Fresh-Install
 - CD-Rom Required

○ **Netinstall**

- Via network using NetInstall program.
- For PC Router (Fresh-Install / Re-Install)
 - PXE, EtherBoot Required
- For Reinstall Routerboard

Download Area

Software Instalasi

CD Instalation

Jika Anda bermaksud menginstall Mikrotik di PC Anda, mungkin file inilah yang Anda butuhkan untuk membuat CD Boot instalasi. [[panduan](#)]

[mikrotik-4.17.iso](#) (19.16 MByte, didownload 8655 kali)

Mikrotik NetInstall

Software yang dibutuhkan untuk melakukan netinstall. Masih dibutuhkan juga modul all_packages di bawah. [[panduan](#)].

[netinstall.zip](#) (6.05 MByte, didownload 37519 kali)

[netinstall-4.17.zip](#) (11.11 MByte, didownload 3283 kali)

- **Mikrotik.co.id – Download Area**
 - Connected 1Gbps to OpenIXP.
- **Mikrotik.com – Download Area**

CD Installation (1)

- Download ISO file (mikrotik-***.iso) dan buatlah CD bootable dengan file tersebut.

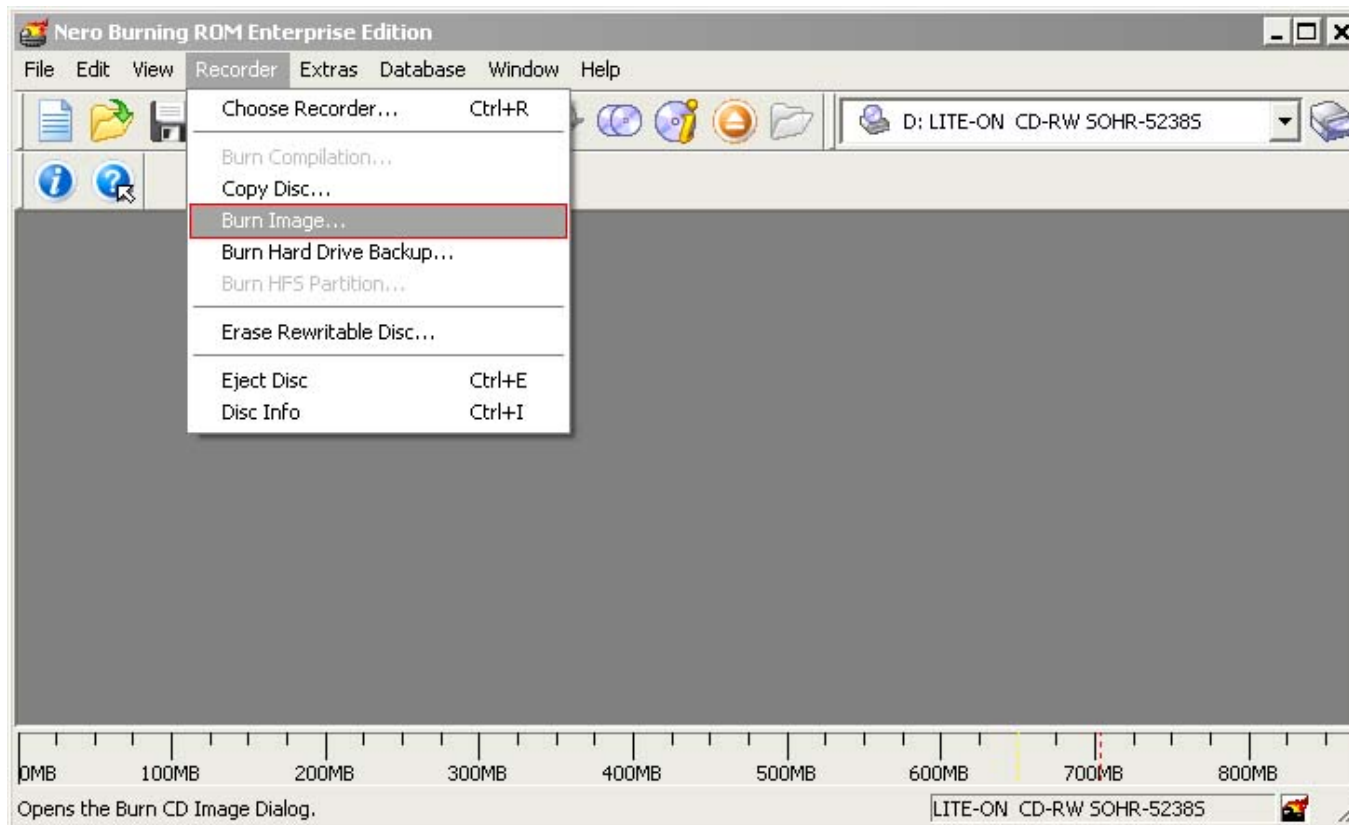

CD Installation (2)

- Gunakanlah CD yang telah dibuat untuk melakukan booting pada komputer
- Pilihlah module yang ingin diinstall

```
Welcome to MikroTik Router Software installation
```

```
Move around menu using 'p' and 'n' or arrow keys, select with 'spacebar'.  
Select all with 'a', minimum with 'm'. Press 'i' to install locally or 'r' to  
install remote router or 'q' to cancel and reboot.
```

```
[X] system          [ ] isdn           [ ] synchronous  
[X] ppp            [ ] lcd           [ ] telephony  
[X] dhcp           [ ] ntp           [ ] ups  
[X] advanced-tools [ ] radiolan      [ ] web-proxy  
[ ] arlan         [ ] routerboard  [ ] wireless  
[ ] gps           [X] routing  
[ ] hotspot       [X] security
```

CD Installation (3)

- Warning: all data on the disk will be erased!
Continue? [y/n]
Choose Yes
- Do you want to keep old configuration? [y/n]:
Yes/No
- Creating partition...
- Formatting disk...
- Software installed.
- Press ENTER to reboot

Installation Check

- Default Login User dan password
 - user = admin dan password = [kosong]
- Welcome menu

```
MikroTik 3.20  
MikroTik Login: admin  
Password: _
```

Demo

- License level 0 = Demo time 24 jam

```
MMM      MMM      KKK      TTTTTTTTTTTT      KKK
MMMM     MMMM     KKK      TTTTTTTTTTTT      KKK
MMM MMMM  MMM  III  KKK  KKK  RRRRRR      000000      TTT      III  KKK  KKK
MMM  MM   MMM  III  KKKKK  RRR  RRR  000  000      TTT      III  KKKKK
MMM      MMM  III  KKK  KKK  RRRRRR      000  000      TTT      III  KKK  KKK
MMM      MMM  III  KKK  KKK  RRR  RRR      000000      TTT      III  KKK  KKK
```

MikroTik RouterOS 3.20 (c) 1999-2009

<http://www.mikrotik.com/>

ROUTER HAS NO SOFTWARE KEY

You have 23h49m to configure the router to be remotely accessible,
and to enter the key by pasting it in a Telnet window or in Winbox.
See www.mikrotik.com/key for more details.

Current installation "software ID": FTGX-E1N
Please press "Enter" to continue!

[admin@MikroTik] > _

Access the Router (First Time)

- **Direct Console** (Keyboard & Monitor)
- **MAC-Telnet** – NeighbourViewer.exe
- **MAC-Winbox** – winbox.exe

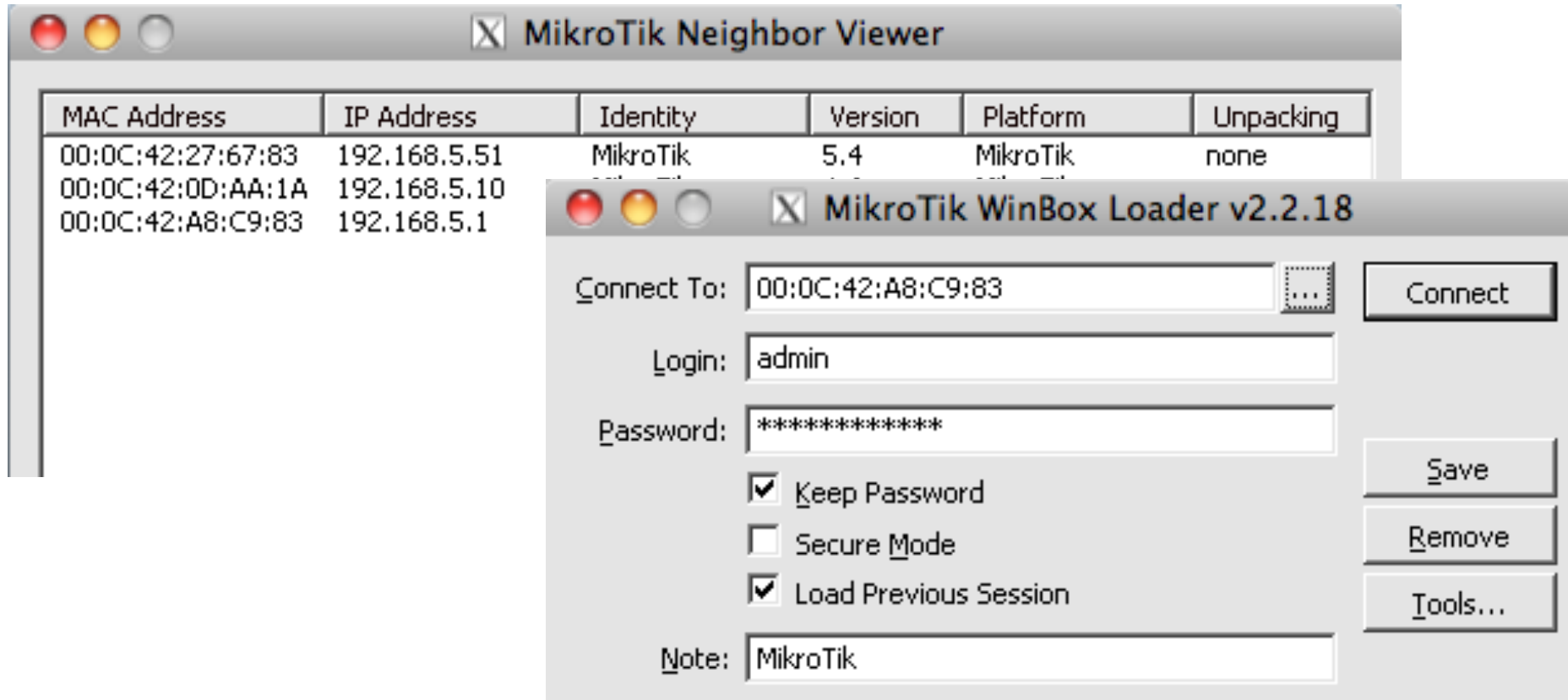

Input License (Telnet)

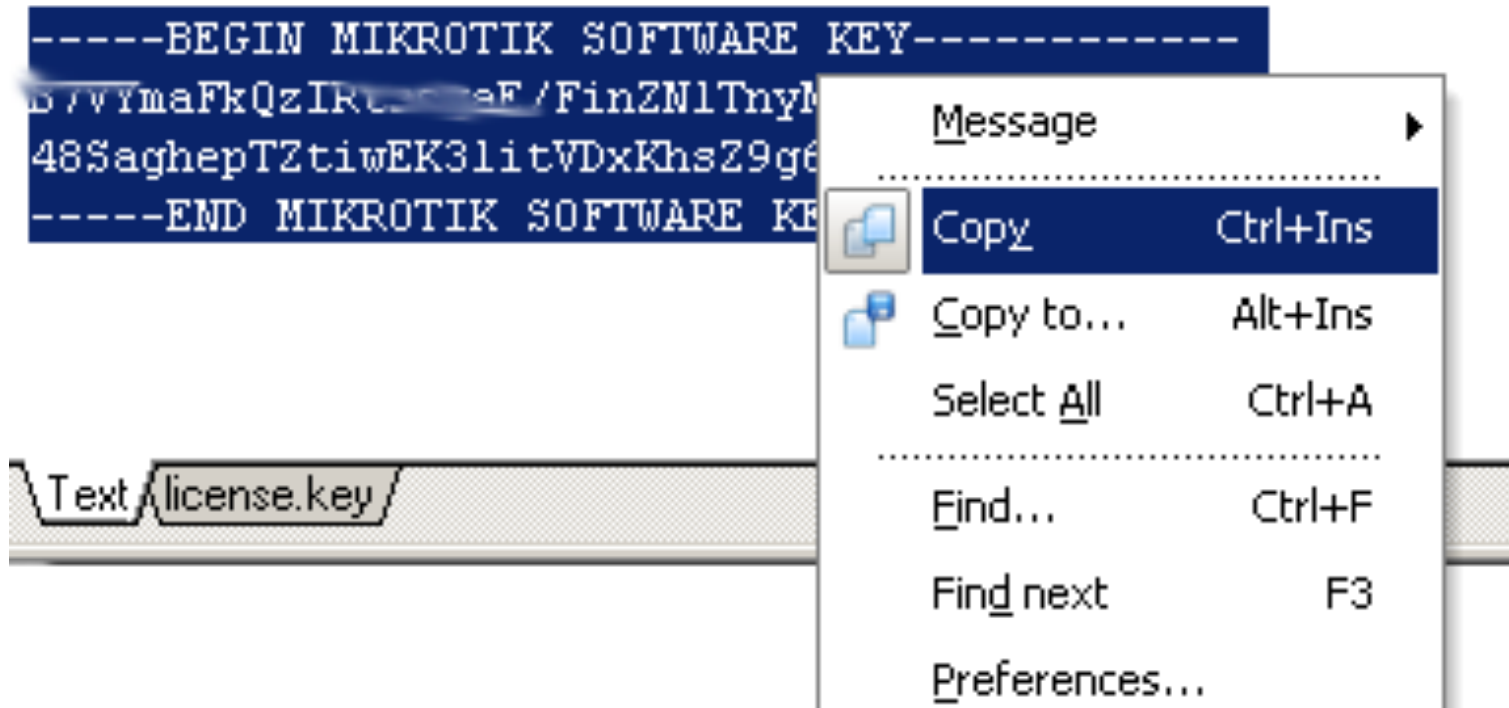

Mikrotik v2.9.7

Login: admin

Password:

```
  MMM          MMM          KKK          TTTTTTTTTT
  MMMM        MMMM          KKK          TTTTTTTTTT
  MMM MMMM   MMM   III   KKK   KKK   RRRRRR   000000   TTT
  MMM  MM   MMM   III   KKKKK   RRR   RRR   000   000   TTT
  MMM          MMM   III   KKK   KKK   RRRRRR   000   000   TTT
  MMM          MMM   III   KKK   KKK   RRR   RRR   000000   TTT
Mikrotik RouterOS 2.9.7 (c) 1999-2005          www.mikrotik.
```

Terminal ansi detected, using single line input mode

[admin@3] > _

Mark

Copy Enter

Paste

Select All

Scroll

```
[admin@3] > -----BEGIN MIKROTIK SOFTWARE KEY-----
key> 1XQjbaQuuwNIiUtplp9v0_728a00CMPRg/9c...
key> -----END MIKROTIK SOFTWARE KEY-----
<ect. Reboot? [y/N]: _
```

Input License (Winbox)

```
-----BEGIN MIKROTIK SOFTWARE KEY-----  
S7vYmaFkQzIR...eF/FinZN1TnyM  
48SaghepTZtiwEK3litVDxKhsZ9g6  
-----END MIKROTIK SOFTWARE KE
```

The screenshot shows the 'License' dialog box in Winbox. The dialog has a title bar with 'License' and a close button. On the left, there are several input fields: 'Software ID' with the value 'F724-MMT', 'Upgradable To' (empty), 'Level' with the value '0', 'Features' (empty), and 'Expires In' with the value '15:39:27'. On the right side, there is a vertical stack of buttons: 'OK', 'Paste Key' (highlighted with a red rectangle), 'Import Key...', 'Export Key...', 'Upgrade/Get New Key...', and 'Update Key'.

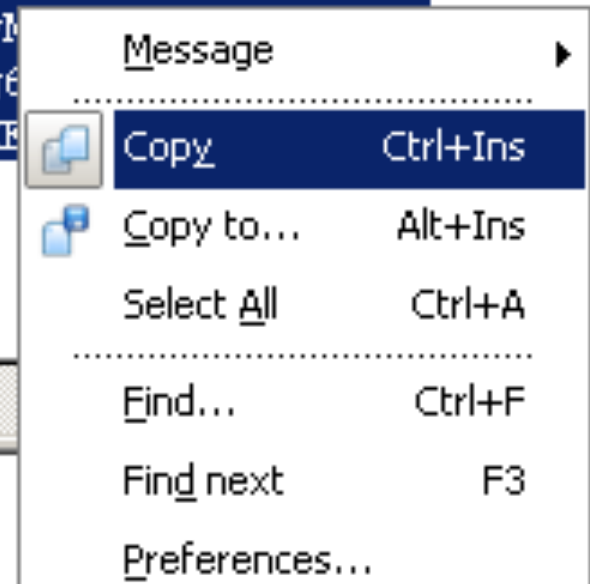

Netinstall

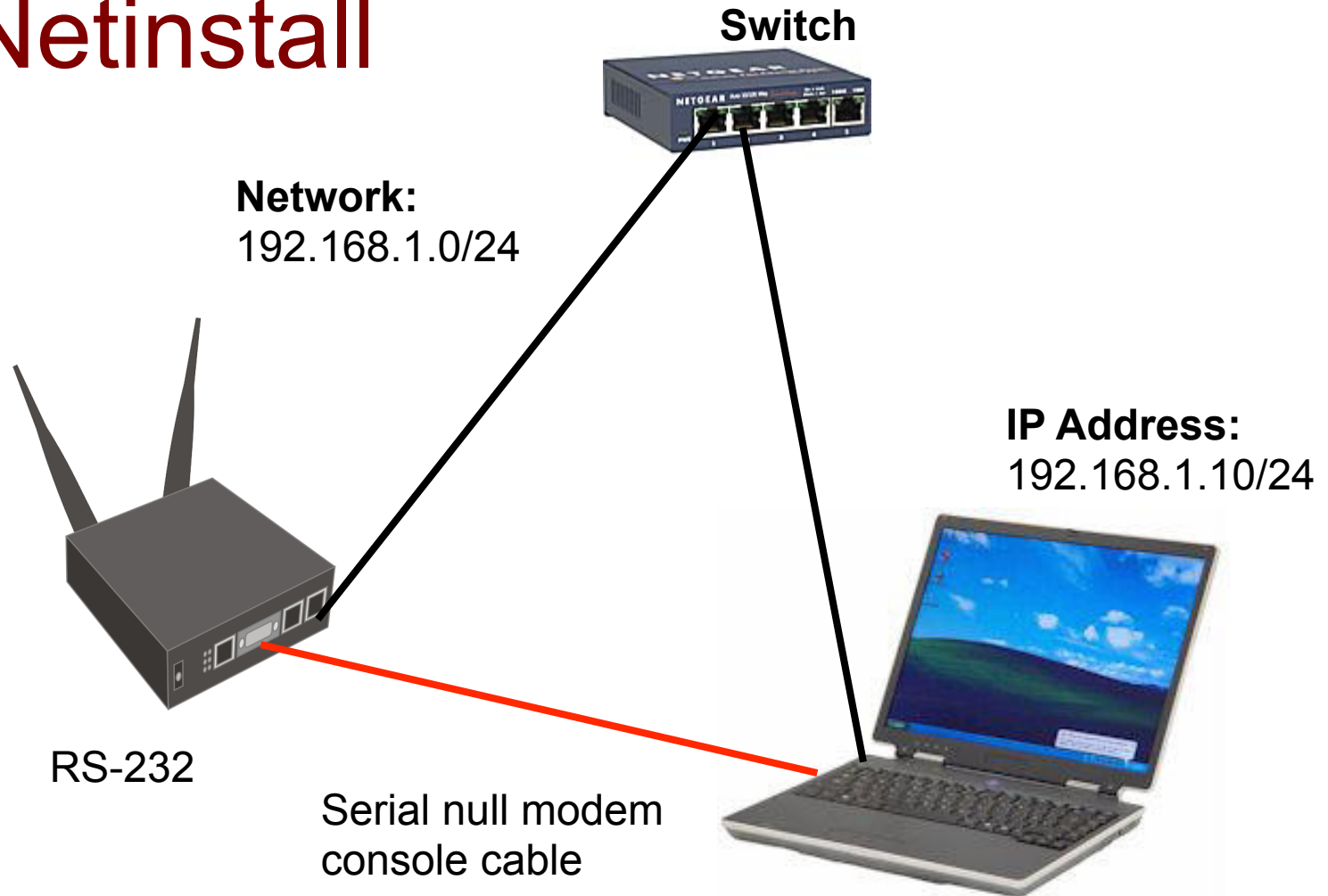

- o Metode Netinstall biasa digunakan untuk melakukan install ulang RouterBoard / PC Router yang sudah support net-boot.

Netinstall

- Download program netinstall dan module yang dibutuhkan

Mikrotik NetInstall

Software yang dibutuhkan untuk melakukan netinstall. Masih dibutuhkan juga modul all_packages di bawah. [[panduan](#)].

[netinstall.zip](#) (6.05 MByte, didownload 37519 kali)

[netinstall-4.17.zip](#) (11.11 MByte, didownload 3283 kali)

Software Upgrade

Semua modul dalam satu paket

Satu buah paket yang berisikan semua modul Mikrotik. Untuk penggunaan versi 2.9 atau yang lebih baru, gunakanlah paket ini. [[panduan](#)]

[routeros-mipsbe-4.17.npk](#) (12.21 MByte, didownload 4262 kali)

[routeros-mipsle-4.17.npk](#) (11.79 MByte, didownload 901 kali)

[routeros-powerpc-4.17.npk](#) (11.92 MByte, didownload 1040 kali)

[routeros-x86-4.17.npk](#) (14.57 MByte, didownload 1576 kali)

Netinstall

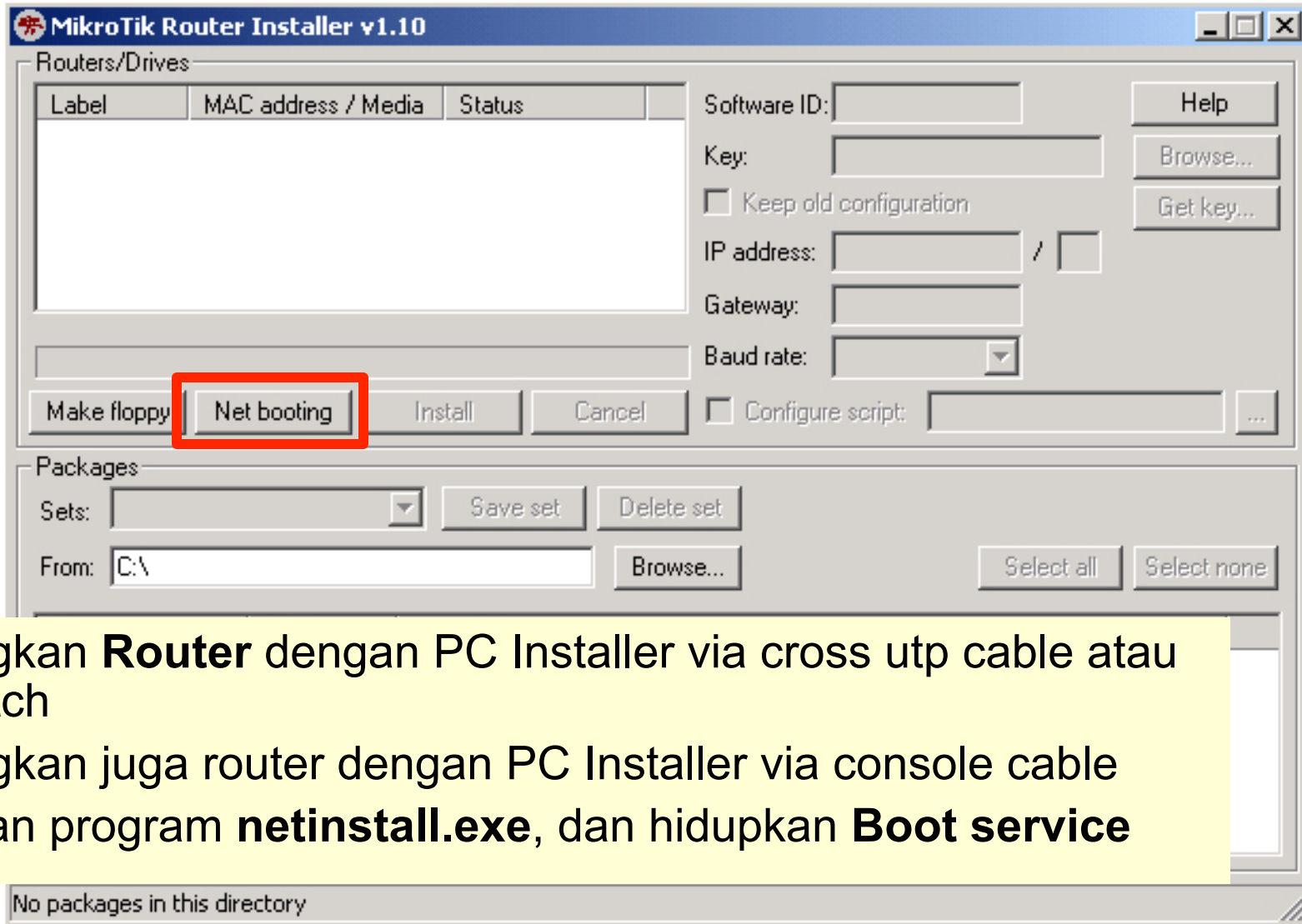

- Hubungkan **Router** dengan PC Installer via cross utp cable atau via switch
- Hubungkan juga router dengan PC Installer via console cable
- Jalankan program **netinstall.exe**, dan hidupkan **Boot service**

Netinstall - Config

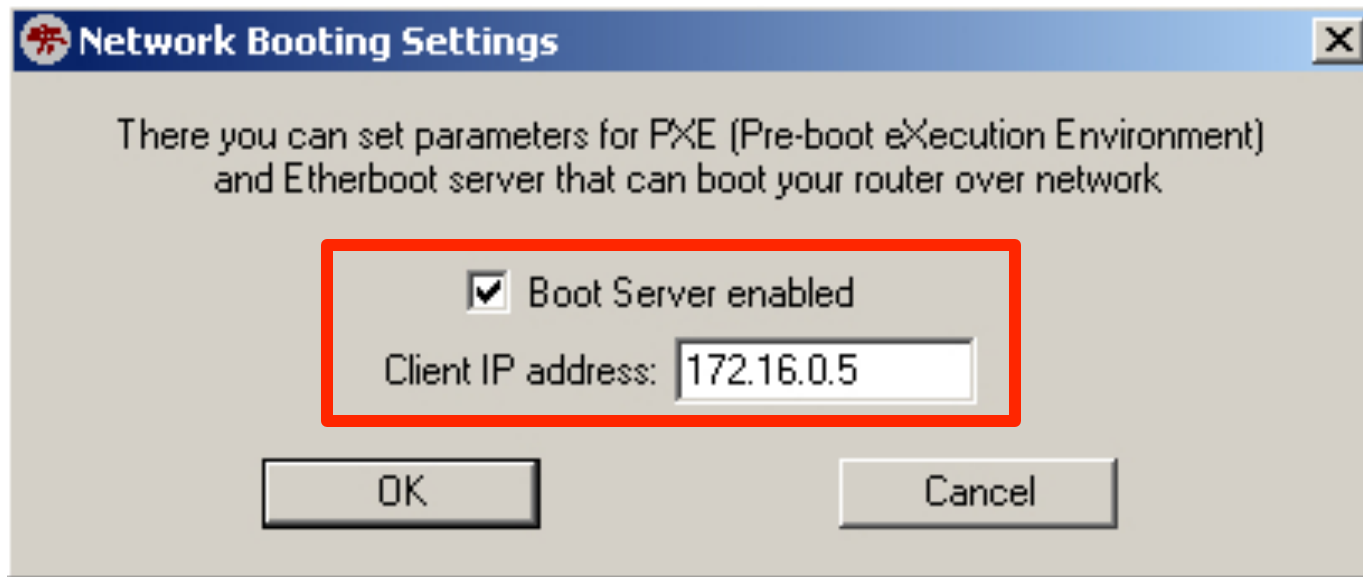

Masukkanlah **IP Address** yang berbeda dengan IP Address laptop / komputer Anda, namun berada dalam **subnet yang sama**

Netinstall – BIOS Setting

- Hidupkan router, masuk ke setting BIOS

```
RouterBOOT booter 2.12
```

```
RouterBoard 333
```

```
CPU frequency: 333 MHz
```

```
Memory size: 64 MB
```

```
Press any key within 2 seconds to enter setup
```

Netinstall – BIOS Setting

```
RouterBOOT-2.12
What do you want to configure?
  d - boot delay
  k - boot key
  s - serial console
  o - boot device
  f - cpu frequency
  r - reset booter configuration
  n - nand
  g - upgrade firmware
  i - board info
  p - boot protocol
  t - do memory testing
  x - exit setup
your choice: o - boot device
```

- o **Pilih boot via ethernet Restart**

Netinstall – BIOS Setting

Select boot device:

```
* e - boot over Ethernet
n - boot from NAND, if fail then Ethernet
l - boot Ethernet once, then NAND
o - boot from NAND only
b - boot chosen device
your choice: █
```

Netinstall - Install

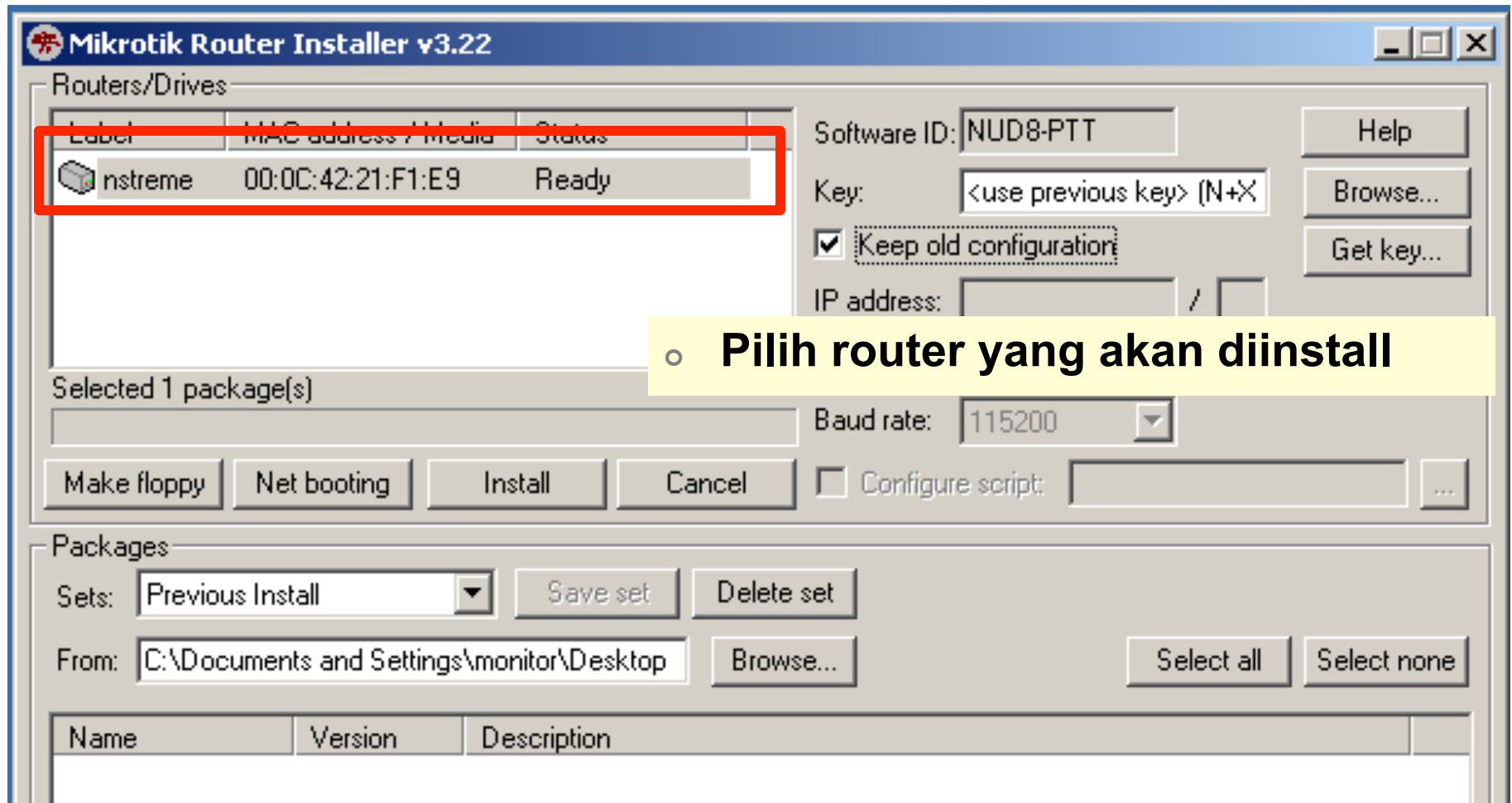

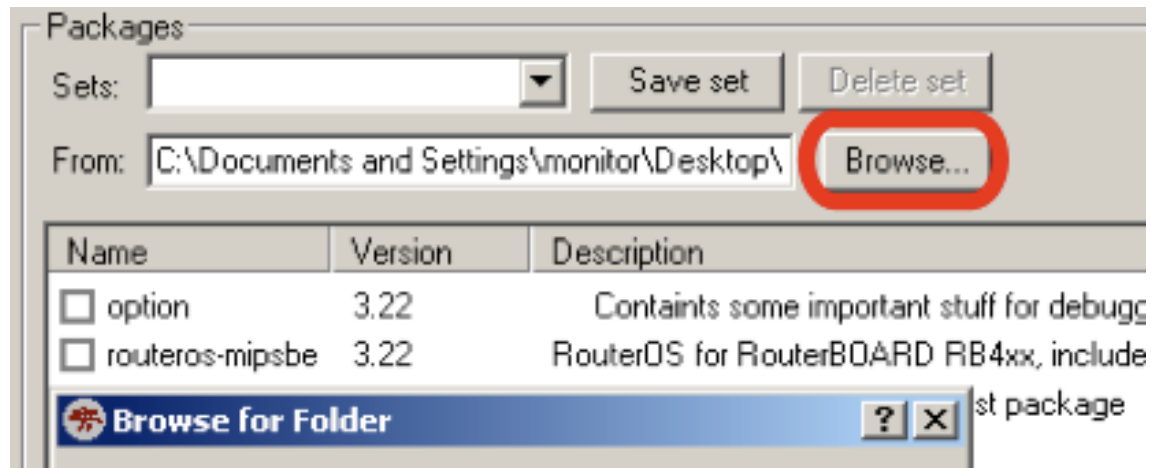

- o **Pilih module yang akan diinstall**

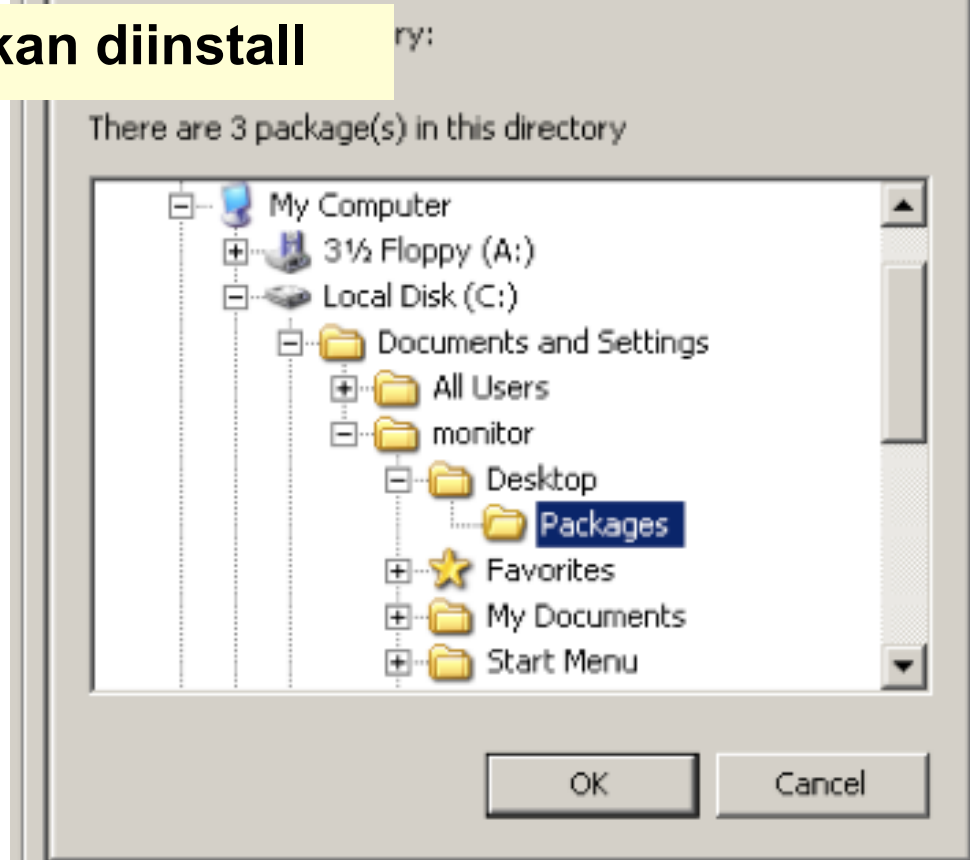

Netinstall - Install

Mikrotik Router Installer v3.22

Routers/Drives

Label	MAC address / Media	Status
nstreme	00:0C:42:21:F1:E9	Ready

Selected 1 package(s)

Software ID: NUD8-PTT
Key: <use previous key> (N+X)
 Keep old configuration
IP address: /
Gateway:
Baud rate: 115200
 Configure script: ...

Buttons: Make floppy, Net booting, **Install**, Cancel, Help, Browse..., Get key...

Packages

Sets: Save set Delete set

From: C:\Documents and Settings\monitor\Desktop\ Browse... Select all Select none

Name	Version	Description
<input checked="" type="checkbox"/> routeros-mipsbe	3.22	RouterOS for RouterBOARD RB4xx, includes all supported features

Start install Selesai

Netinstall – Reboot

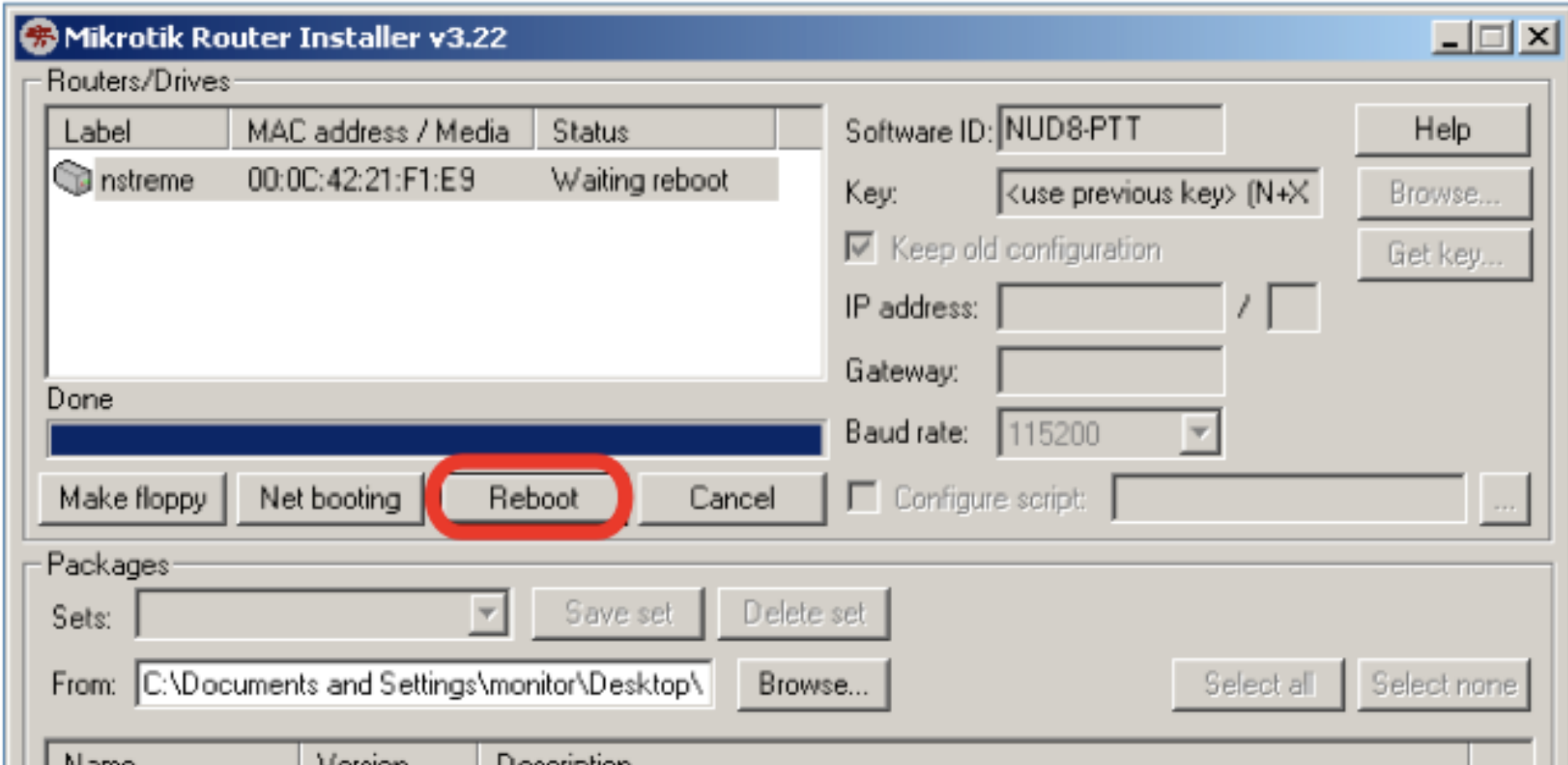

Netinstall - Cleanup

```
Select boot device:  
* e - boot over Ethernet  
n - boot from NAND, if fail then Ethernet  
l - boot Ethernet once, then NAND  
o - boot from NAND only  
b - boot chosen device  
your choice: █
```

- **Kembalikan boot ke IDE / NAND drive**

- **Video Tutorial :**
 - http://www.mikrotik.co.id/artikel_lihat.php?id=25

Reset Password

- Reset password bisa dilakukan di beberapa routerboard menggunakan tombol “**Reset**”



- Hard Reset :

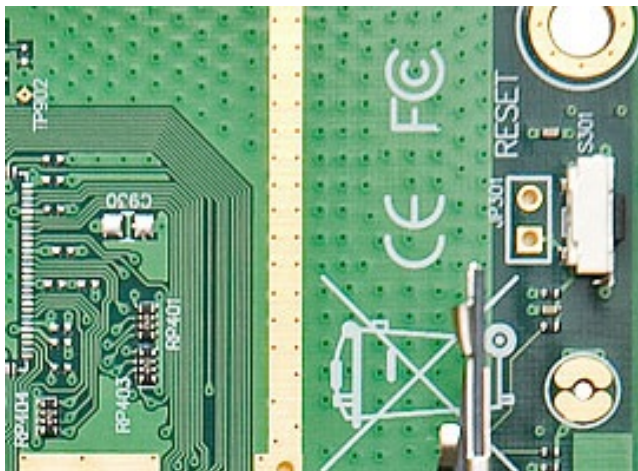

To reset RouterOS config
Hold metal object in here
while the board boots.



System Package Check

- Pada terminal: `/system package print`

	Name	Version	Build Time	Scheduled
	routeros-x86	3.22	Mar/16/2009 10:48:17	
	advancedt...	3.22	Mar/16/2009 10:43:47	
	dhcp	3.22	Mar/16/2009 10:43:58	
	hotspot	3.22	Mar/16/2009 10:45:17	
X	ipv6	3.22	Mar/16/2009 10:44:58	
X	mpls	3.22	Mar/16/2009 10:47:02	
	ppp	3.22	Mar/16/2009 10:44:05	
	routerboard	3.22	Mar/16/2009 10:46:46	
	routing	3.22	Mar/16/2009 10:44:10	
	security	3.22	Mar/16/2009 10:43:55	
	system	3.22	Mar/16/2009 10:43:27	
	wireless	3.22	Mar/16/2009 10:45:50	

RouterOS Package

Nama Paket	Fungsi
advanced-tools	email client, ping, netwatch
dhcp	DHCP server dan client
hotspot	hotspot gateway
ntp	NTP server
ppp	PPP,PPTP,L2TP,PPPoE
routerboard	Fungsi khusus Routerboard
routing	RIP, OSPF, BGP
security	secure winbox, SSH, IPSec
wireless	Wireless 802.11a/b/g
user-manager	User-Manager management system
ipv6	IPv6

Version Upgrade

- Download modul terlebih dahulu
 - routers-mipsbe-3.xx.npk (RB400 & RB700)
 - routers-mipsle-3.xx.npk (RB100 & RB500)
 - routers-powerpc-3.xx.npk (RB300 & RB600)
 - routers-x86-3.xx.npk (PC & RB200)
- FTP modul tersebut ke router
 - Harus menggunakan userid yang full access
 - FTP://xxx.xxx.xxx.xxx ← **IP Router**
- Soft Reboot, jangan hard reboot
 - Command - **"/system reboot"**

FTP ke Router

IP Router

FTP (File Transfer Protocol)

Server: 192.168.5.10 Port: 21

URL: <ftp://admin@192.168.5.10:21/>

Username: admin

Password: Password

Filename	Size	Modified
autosupout.old.rif	257.6 KB	8/3/10 7:46 PM
autosupout.rif	258.6 KB	9/15/10 11:08 AM
custlogo.bmp	3.8 KB	4/19/11 10:47 AM
DKIN-USDN.key	204 B	9/5/10 6:01 PM
MRC-Sheet - 114501D7BF15.txt	1.1 KB	4/12/11 12:38 PM
route.rsc	217 B	Today 10:19 AM
V90L-3TT.key	203 B	9/5/10 5:57 PM

Version Downgrade

- Download modul yang lama
- FTP dan copykan modul OS versi yang lama tersebut ke FTP router.
- Cek modul : */file print*
- **“/system package downgrade”**
admin@MikroTik] system package> downgrade
Router will be rebooted. Continue? [y/N]: y
system will reboot shortly

Command Line Interface

- Struktur *Command* dalam mikrotik mirip dengan shell dalam unix
- Dibagi ke dalam beberapa kelompok sesuai hirarki menu levelnya
- Misalnya menambahkan ip address
 - *ip address add address=192.168.0.1/24 interface=ether1*
 - Menu **ip** (level0) memiliki sub menu **address** (level1)

General Command CLI

add	menambahkan entri tertentu
comment	membubuhkan komentar pada suatu entri
disable	menonaktifkan entri tertentu
enable	mengaktifkan entri tertentu
monitor	memonitor parameter secara live
print	menampilkan semua entri secara singkat
print detail	menampilkan semua entri secara lengkap
remove	menghapus entri tertentu
set	mengubah parameter tertentu pada sebuah entri

● ● ● | Navigasi pada CLI

?	Menampilkan pilihan perintah yang tersedia beserta keterangannya
[TAB]	Melengkapi perintah yang baru terketik sebagian
[TAB][TAB]	Menampilkan pilihan perintah yang tersedia beserta keterangannya
..	Berpindah 1 level ke atas pada hirarki menu
/	Berpindah ke level teratas pada hirarki menu

Command Line Interface

- Quick Typing
 - [TAB] untuk melengkapi perintah tertentu
 - */system shut [TAB] = /system shutdown*
 - Juga bisa menggunakan singkatan
 - */sys shut = /system shutdown*



RouterOS Basic Configuration



Certified Mikrotik Training Basic Class

Organized by: Citraweb Nusa Infomedia

(Mikrotik Certified Training Partner)

Winbox - Download

- Download terlebih dahulu program **winbox.exe** untuk mengkonfigurasi RouterOS Mikrotik.

Mikrotik Utility

Winbox

Utility untuk melakukan remote GUI ke Router Mikrotik. For windows.

[winbox-2.2.13.exe](#) (34.5 KByte, didownload 376887 kali)

[winbox-2.2.11.exe](#) (34.5 KByte, didownload 76782 kali)

[winbox-2.2.10.exe](#) (34.5 KByte, didownload 60046 kali)

[winbox-2.2.15.exe](#) (36.5 KByte, didownload 239230 kali)

[winbox-2.2.18.exe](#) (111.5 KByte, didownload 36747 kali)

Basic Config - Topology

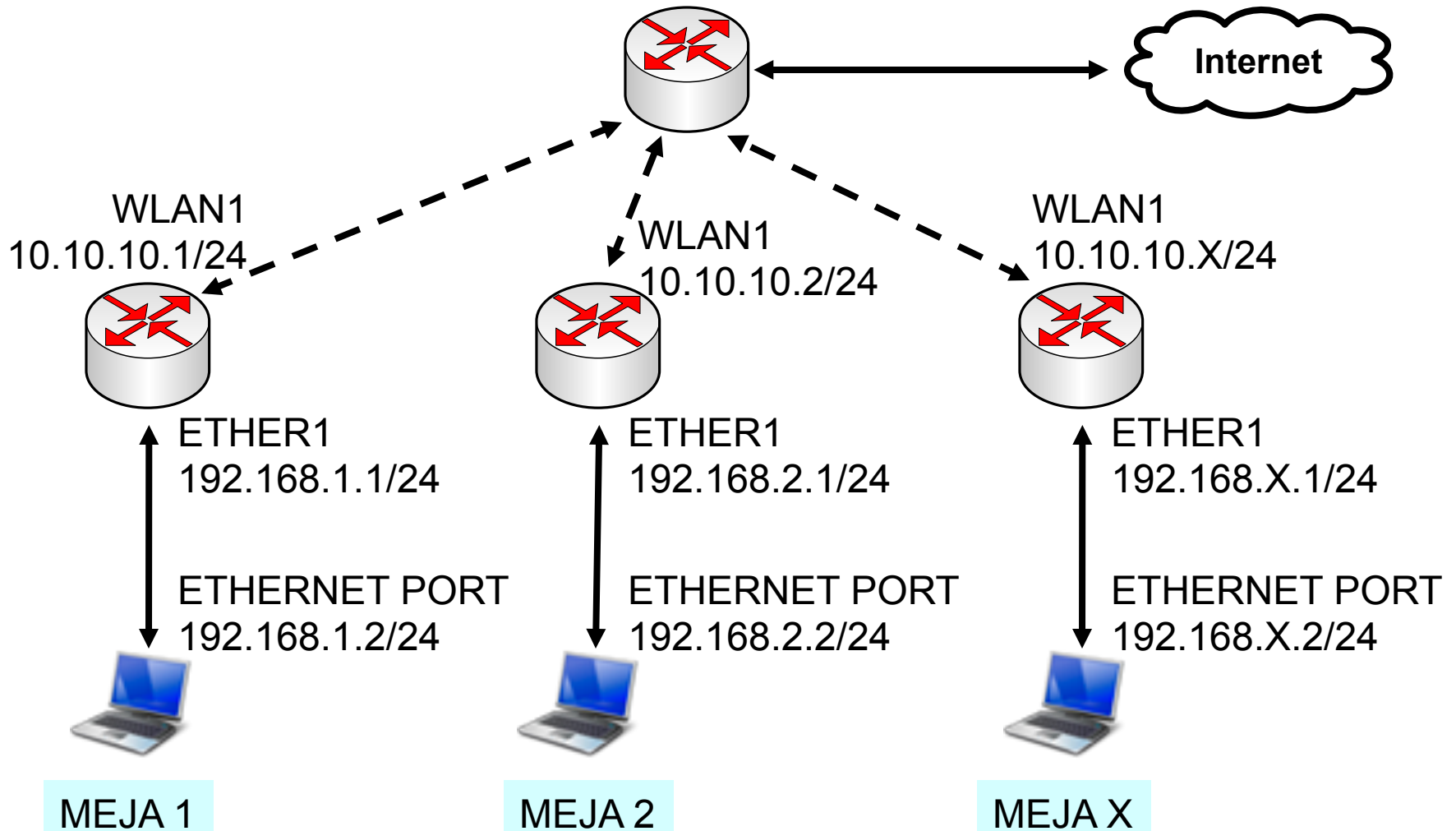

IP Configuration

Lab-1 adalah sebuah simulasi konfigurasi dasar sebuah Router Mikrotik yang akan digunakan di jaringan local seperti **Warnet, Office, Kampus** atau bahkan di **RT/RW-NET**

X = nomor peserta

- Routerboard Setting
 - WAN IP : 10.10.10.x/24
 - Gateway : 10.10.10.100
 - LAN IP : 192.168.x.1/24
 - DNS : 10.100.100.1
 - Src-NAT and DNS Server
- Laptop Setting
 - IP Address : 192.168.x.2/24
 - Gateway : 192.168.x.1
 - DNS : 192.168.x.1

Laptop Config

- Konfigurasi ip-address statik pada laptop.

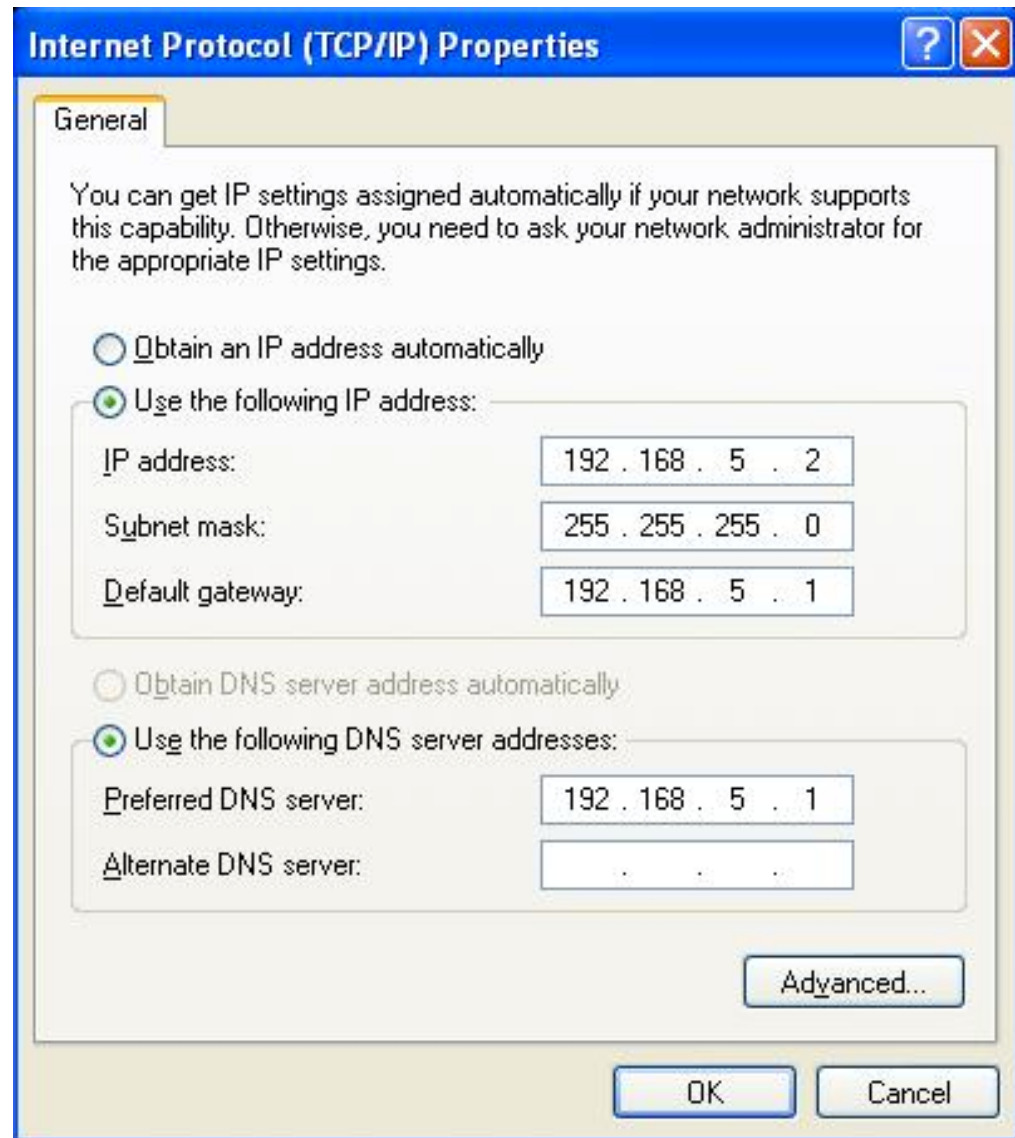

First Setup

- Hubungkan port ethernet Laptop Anda dengan **ether1** pada Routerboard.
- Pastikan ethernet port di laptop Anda memiliki IP statik
- Jalankan program winbox.exe, klik pada tombol [...] untuk melihat router Anda.

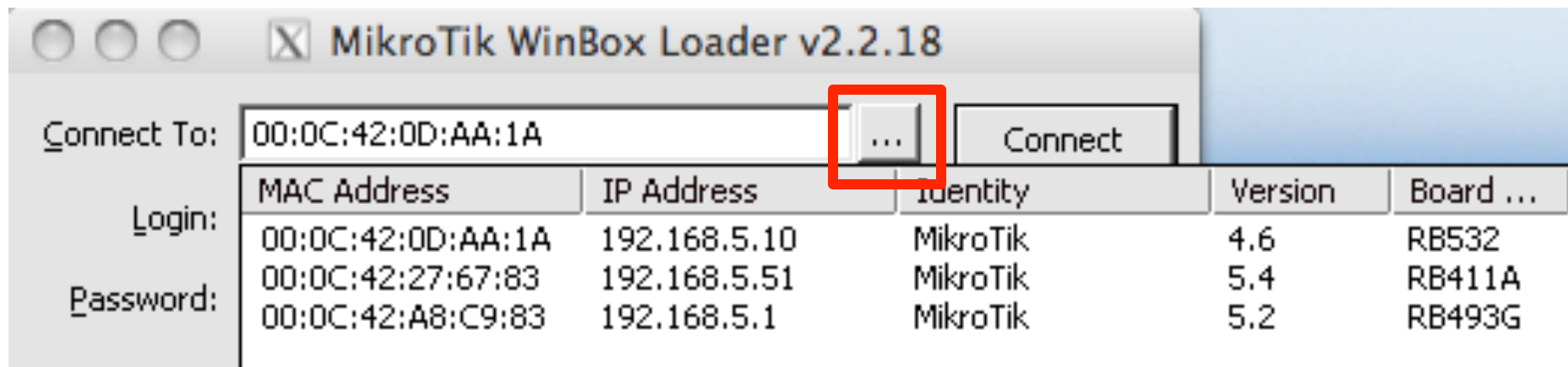

[LAB-1] System Identity

- Supaya tidak membingungkan, ubahlah nama router Anda.
- Format: **xx>NamaAnda**
- Contoh: 01-Budi-Wahyu
- Aktifkan semua interface

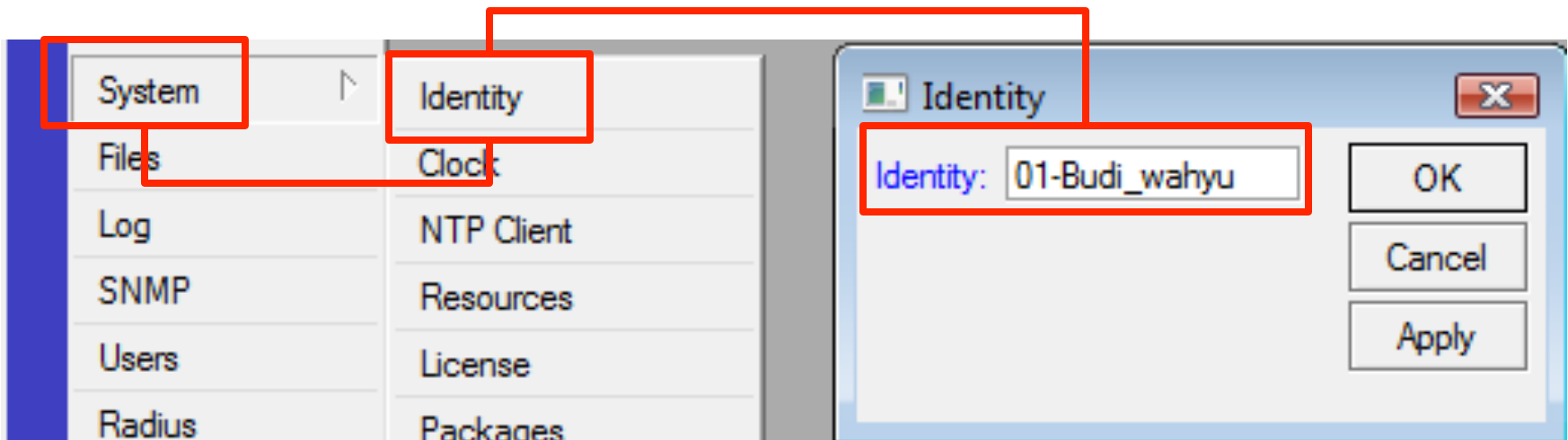

[LAB-2] Wireless Config

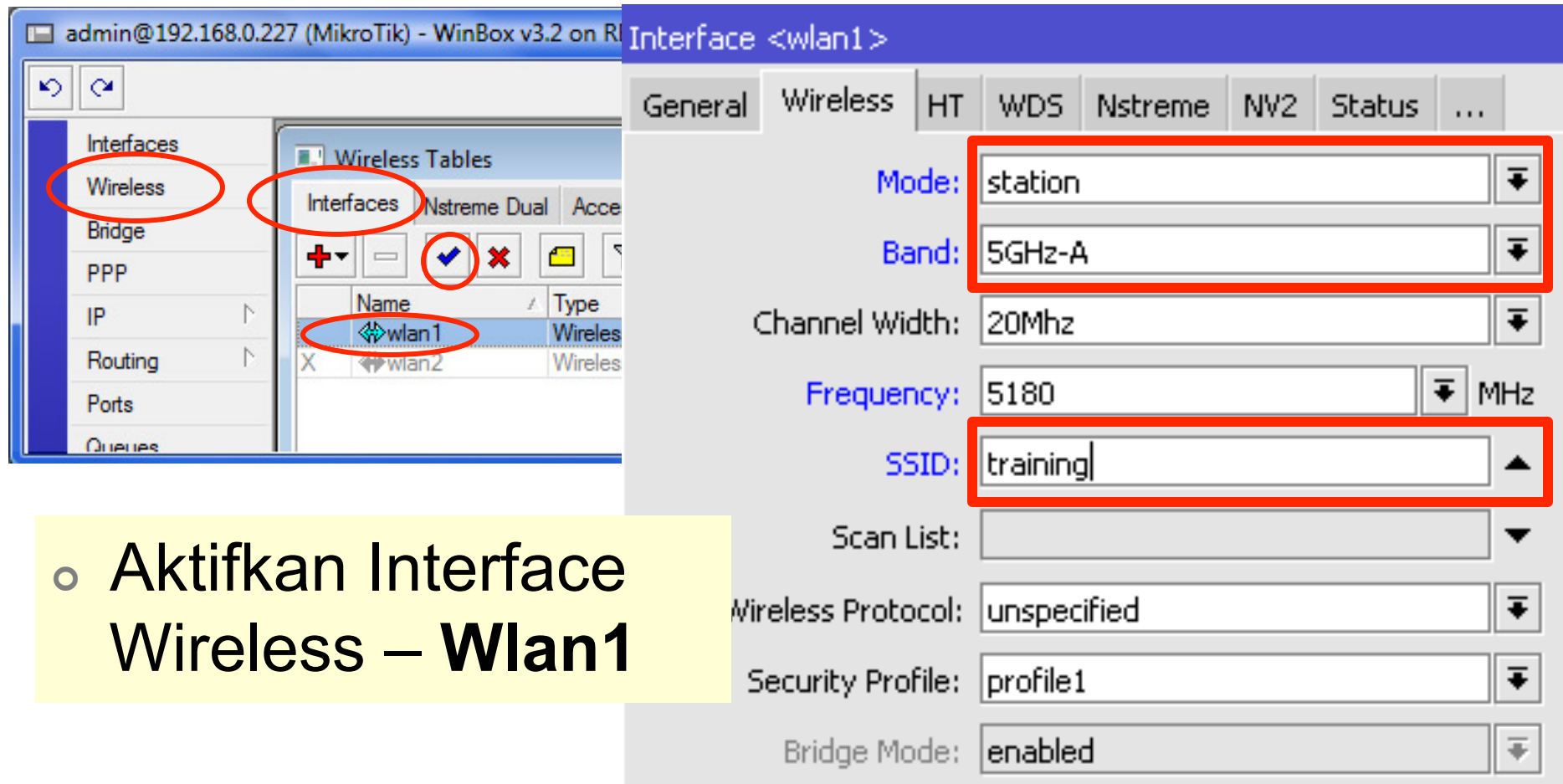

The image shows two screenshots from the Mikrotik WinBox interface. The left screenshot displays the 'Wireless Tables' window with a table containing two entries: 'wlan1' and 'wlan2'. The 'wlan1' entry is selected, and a checkmark icon in the toolbar is highlighted with a red circle. The right screenshot shows the configuration page for the 'wlan1' interface, with several fields highlighted by red boxes: 'Mode' set to 'station', 'Band' set to '5GHz-A', and 'SSID' set to 'training'.

admin@192.168.0.227 (MikroTik) - WinBox v3.2 on R... Interface <wlan1>

General Wireless HT WDS Nstreme NV2 Status ...

Mode: station

Band: 5GHz-A

Channel Width: 20Mhz

Frequency: 5180 MHz

SSID: training

Scan List:

Wireless Protocol: unspecified

Security Profile: profile1

Bridge Mode: enabled

- o Aktifkan Interface Wireless – **Wlan1**

[LAB-3] IP Address Config

The image shows the Mikrotik WinBox interface for configuring IP addresses. On the left sidebar, the 'Addresses' menu item is highlighted with a red box. In the main window, the 'Address List' table is visible, and a red circle highlights the '+' icon used to add a new address. Two 'New Address' dialog boxes are shown, both with red boxes around their input fields. The first dialog is for interface 'wlan1' with the address '10.10.10.x/24'. The second dialog is for interface 'ether1' with the address '192.168.x.1/24'. Red lines connect the '+' icon to the 'New Address' dialog boxes.

Address
1.1.1.1
2.2.2.1
192.16
192.16

New Address (wlan1)

Address: 10.10.10.x/24
Network: []
Broadcast: []
Interface: wlan1

New Address (ether1)

Address: 192.168.x.1/24
Network: []
Broadcast: []
Interface: ether1

[LAB-4] Gateway Config

The screenshot displays the Mikrotik WinBox interface for configuring a new route. The left sidebar shows the 'Routes' menu item highlighted. A red box highlights the '+' icon in the 'Routes' section. The main window shows the 'New Route' configuration form with the following fields:

Field	Value
Dst. Address	0.0.0.0/0
Gateway	10.10.10.100
Check Gateway	
Type	unicast
Distance	
Scope	30
Target Scope	10
Routing Mark	
Pref. Source	

[LAB-5] DNS Config

- ARP
- Accounting
- Addresses
- DNS**
- Firewall
- Neighbors
- Packing
- Pool
- Routes
- SNMP

The screenshot shows the Mikrotik WinBox interface for configuring DNS. The left sidebar has 'DNS' selected. The main window shows the 'Static' tab of the DNS configuration. A 'Settings' button is circled in red. A 'DNS Settings' dialog box is open, showing the following configuration:

#	Name	Address	TTL (s)
		10.100.100.1	
		8.8.8.8	
		0.0.0.0	

DNS Settings

Servers: 10.100.100.1, 8.8.8.8, 0.0.0.0

Allow Remote Requests

Max UDP Packet Size: 512

Cache Size: 2048 KiB

Cache Used: 5

[LAB-6] Src-NAT Config

The image shows three overlapping windows from Mikrotik WinBox. The leftmost window is the 'Firewall' main interface, with the 'NAT' tab selected. A red circle highlights the '+' button used to add a new rule. The middle window is the 'NAT Rule <>' configuration dialog, with the 'General' tab active. Red circles highlight the 'Chain' dropdown set to 'srcnat' and the 'Out. Interface' dropdown set to 'wlan1'. The rightmost window is the 'NAT Rule <>' configuration dialog, with the 'Action' tab active. A red circle highlights the 'Action' dropdown set to 'masquerade'. The right side of the rightmost window shows standard buttons: OK, Cancel, Apply, Disable, Comment, Copy, Remove, Reset Counters, and Reset All Counters.

Terminal / Console Config

- Konfigurasi wireless sebagai media untuk backbone
 - `/interface wireless set wlan1 mode=station ssid=training band=2.4.ghz-b/g scan-list=2400-2500 disabled=no`
- Konfigurasi IP Address
 - `/ip address add address=10.10.10.x/24 interface=wlan1`
 - `/ip address add address=192.168.x.1/24 interface=ether1`
- Konfigurasi Routing – Default Gateway
 - `/ip route add gateway=10.10.10.100`
- Konfigurasi DNS
 - `/ip dns set servers=10.100.100.1 allow-remote-request=yes`
- Konfigurasi NAT
 - `/ip firewall nat add chain=srcnat out-interface=wlan1 action=masquerade`



Installation Debug

- Test ping dari **Router** ke **Gateway** (10.10.10.100)
 - Jika error : Cek Wireless connection, Cek IP Address pada wlan1
- Test ping dari **Router** ke **Internet** (contoh: yahoo.com)
 - Jika error : Cek DNS Server Setting
- Test ping dari **Laptop** ke **Router** Anda (10.10.10.x)
 - Jika error : Cek konfigurasi laptop, Cek IP Address pada Ether1
- Test ping dari **Laptop** ke **Gateway** (10.10.10.100)
 - Jika error : Cek Firewall - NAT
- Test ping dari **Laptop** ke **Internet** (contoh: yahoo.com)
 - Jika error : Cek setting DNS pada laptop dan router

● ● ● | Network Time Protocol (NTP)

- NTP protocol memungkinkan sinkronisasi waktu dalam sebuah jaringan
- Mikrotik support sebagai NTP server dan sebagai NTP Client
- NTP Server
 - Install paket **ntp-xxxx-(versi).npk**, karena paket 'system' hanya menyertakan servis ntp client
 - Mode:**broadcast,manycast,multicast**

[LAB-7] NTP

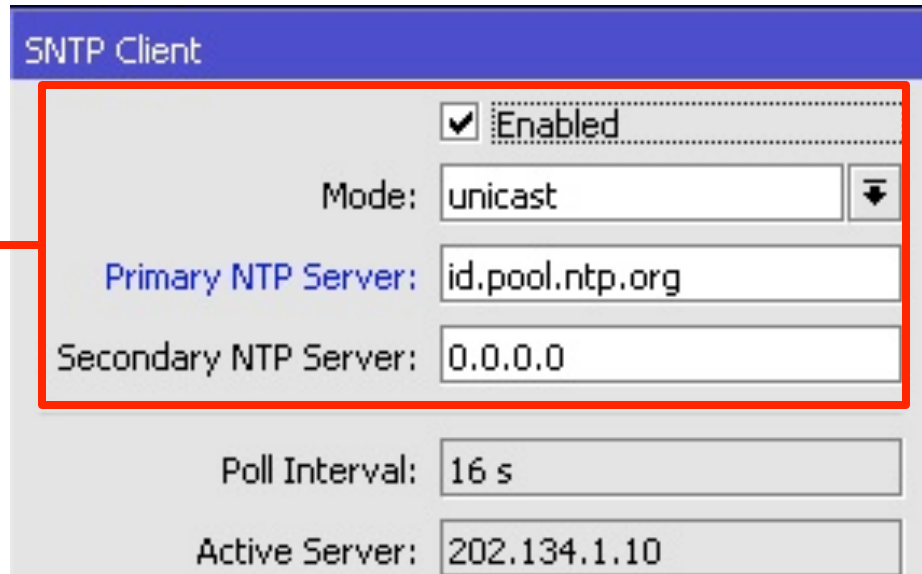
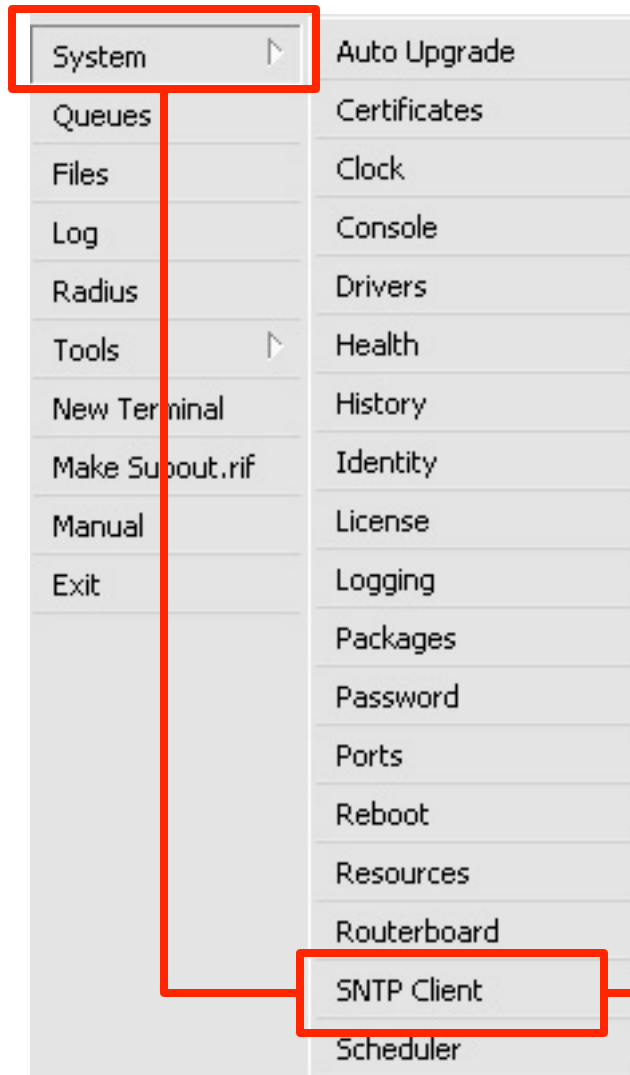

Set enable
Set mode unicast
Set IP NTP server
- id.pool.ntp.org -
- pool.ntp.org -
- ntp.nasa.gov -

System - Clock

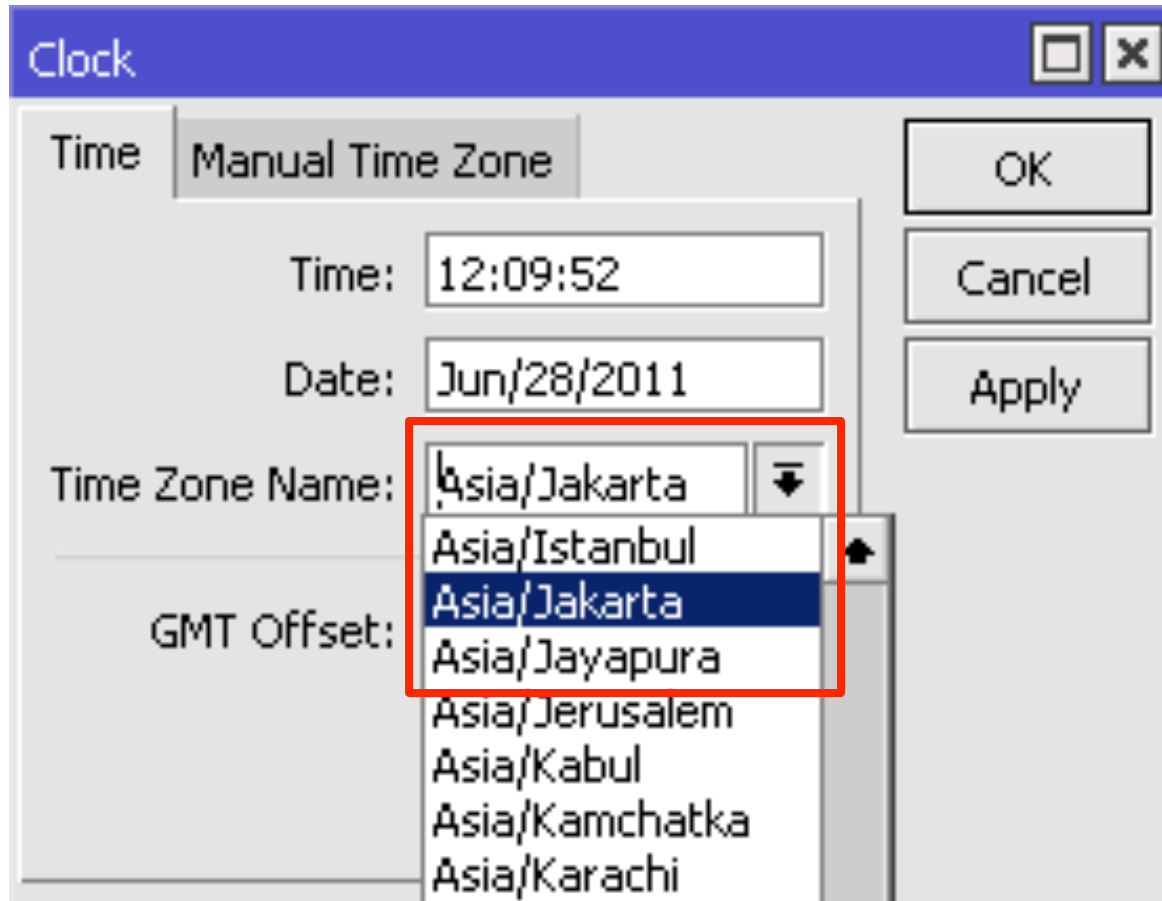

- Sesuaikan time zone lokasi

[LAB-8] Backup Config

admin@00:0C:42:0E:A5:21 (MikroTik) - WinBox v3.2 on RB500R5 (mipsle)

The screenshot shows the WinBox interface with the 'Files' menu item selected in the left sidebar. A 'File List' window is open, displaying a list of files and directories. The 'Backup' button in the File List window is circled in red, and a red line connects it to the 'Files' menu item. The backup file 'MikroTik-01012000-0138.backup' is also circled in red.

File Name	Type	Size	Creation Time
MikroTik-01012000-0138.backup	Backup	12.3 KiB	Jan/01/2
hotspot	Directory	0 B	Jan/01/2
hotspot/login.html	File	1293 B	Jan/01/2
hotspot/error.html	File	898 B	Jan/01/2
hotspot/errors.txt	File	3615 B	Jan/01/2
hotspot/img	Directory	0 B	Jan/01/2
hotspot/img/logobottom.p...	File	4317 B	Jan/01/2
hotspot/img/user-manage...	File	0 B	Jan/01/2
hotspot/login.html	File	3384 B	Jan/01/2
hotspot/logout.html	File	1813 B	Jan/01/2
hotspot/lv	Directory	0 B	Jan/01/2
hotspot/lv/login.html	File	1303 B	Jan/01/2
hotspot/lv/errors.txt	File	3810 B	Jan/01/2
hotspot/lv/login.html	File	3408 B	Jan/01/2
hotspot/lv/logout.html	File	1843 B	Jan/01/2
hotspot/lv/radvert.html	File	1475 B	Jan/01/2
hotspot/lv/status.html	File	2760 B	Jan/01/2
hotspot/md5.js	File	7.0 KiB	Jan/01/2
hotspot/radvert.html	File	1481 B	Jan/01/2
hotspot/redirect.html	File	213 B	Jan/01/2
hotspot/login.html	File	739 B	Jan/01/2
hotspot/status.html	File	3082 B	Jan/01/2

32 items | 33.7 MB of 126.9 M... | 73% free

Backup from CLI

- Jika ingin menentukan nama file backup, bisa melakukan backup melalui console
- Membuat file backup:

```
[admin@MikroTik] > /system backup save name=backup-1  
Saving system configuration  
Configuration backup saved  
[admin@MikroTik] >
```

- File backup dapat dilihat di submenu /file
- Dapat didownload via FTP
- File backup tidak dapat di-edit !

System Reset

- Untuk mengembalikan ke konfigurasi awal (default).
- Perintah ini menghapus semua konfigurasi yang telah dibuat, termasuk user dan password.
- Hanya bisa dilakukan oleh user dengan hak penuh (grup: full)

```
[admin@Router-MikroTik] > system reset  
Dangerous! Reset anyway? [y/N]: y
```

[LAB-9] Restore Configuration

File List

Backup Restore Find

File Name	Type	Size	Creation Time
Mikro Tik-01012000-0138.backup	Backup	12.3 KiB	Jan/01/2
hotspot	Directory	0 B	Jan/01/2
hotspot/alogin.html	File	1293 B	Jan/01/2
hotspot/error.html	File	898 B	Jan/01/2
hotspot/errors.txt	File	3615 B	Jan/01/2
hotspot/img	Directory	0 B	Jan/01/2
hotspot/img/logobottom.p...	File	4317 B	Jan/01/2
hotspot/img/user-manage...	File	0 B	Jan/01/2
hotspot/login.html	File	3384 B	Jan/01/2
hotspot/...	Jan/01/2
hotspot/...	Jan/01/2
hotspot/...	Jan/01/2
hotspot/...	Jan/01/2
hotspot/...	Jan/01/2
hotspot/...	Jan/01/2
hotspot/...	Jan/01/2
hotspot/...	Jan/01/2
hotspot/...	Jan/01/2
hotspot/...	Jan/01/2
hotspot/...	Jan/01/2
hotspot/...	Jan/01/2
hotspot/...	Jan/01/2
hotspot/...	Jan/01/2
hotspot/...	Jan/01/2
hotspot/...	Jan/01/2
hotspot/...	Jan/01/2
hotspot/...	Jan/01/2
hotspot/...	Jan/01/2
hotspot/...	Jan/01/2
hotspot/...	Jan/01/2
hotspot/...	Jan/01/2
hotspot/...	Jan/01/2
hotspot/...	Jan/01/2
hotspot/...	Jan/01/2
hotspot/...	Jan/01/2
hotspot/...	Jan/01/2

Restore

Do you want to restore configuration and reboot?

Yes No

32 items (1 selected) 33.7 MB of 126.9 M... 73% free

Backup – Export Configuration

- Backup bisa dilakukan juga menggunakan perintah export.

```
[admin@MikroTik] > /ip route export
# jun/30/2011 10:16:16 by RouterOS 4.6
# software id = DKIN-USDN
#
/ip route
add comment="" disabled=no distance=1 dst-address=0.0.0.0/0 \
    gateway=192.168.5.1 pref-src=192.168.5.201 scope=30 \
    target-scope=10
[admin@MikroTik] >
```

Backup – Export to File

- Hasil export ini berupa script (text base configuration) yang bisa dilihat dan diedit menggunakan text editor.

```
[admin@MikroTik] > /ip route export file=route.rsc  
[admin@MikroTik] >
```

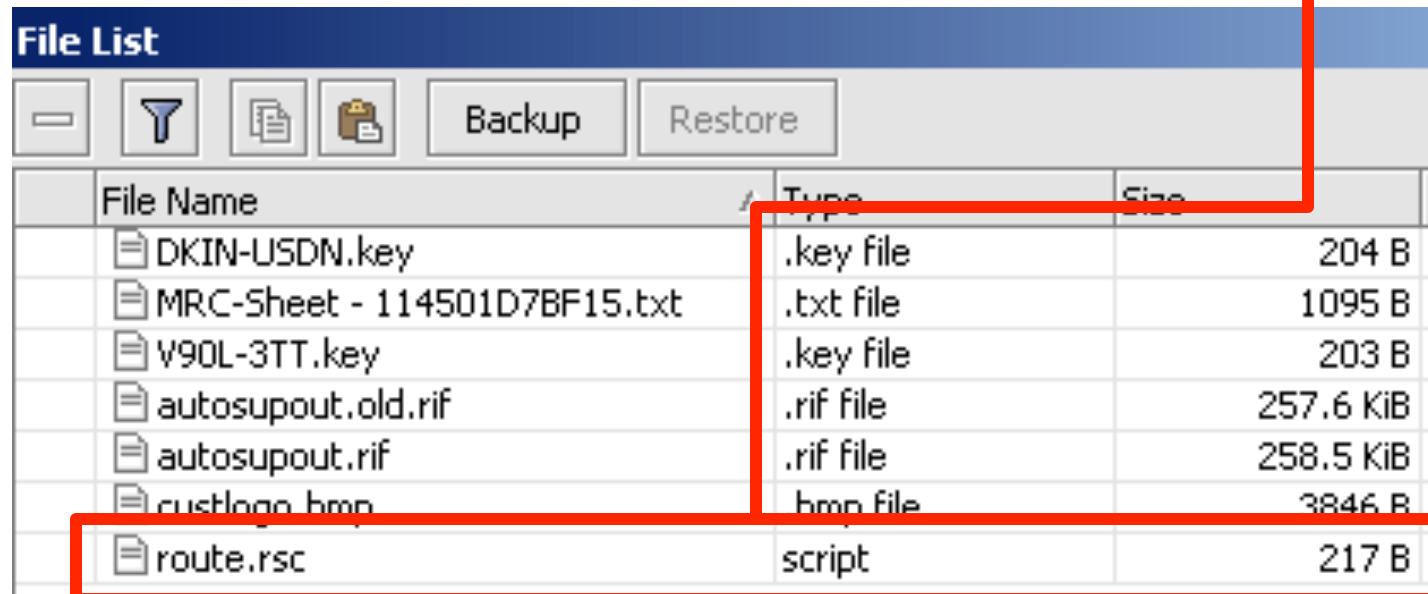

The screenshot shows the 'File List' window in Mikrotik WinBox. The window has a toolbar with icons for folder expansion, search, document, and folder, along with 'Backup' and 'Restore' buttons. Below the toolbar is a table listing files. The file 'route.rsc' is highlighted with a red box, and its details are also highlighted. A red line connects the command in the terminal above to the 'route.rsc' file in the table.

File Name	Type	Size
DKIN-USDN.key	.key file	204 B
MRC-Sheet - 114501D7BF15.txt	.txt file	1095 B
V90L-3TT.key	.key file	203 B
autosupout.old.rif	.rif file	257.6 KIB
autosupout.rif	.rif file	258.5 KIB
custlogo.bmp	bmp file	3846 B
route.rsc	script	217 B

Restore – Import Script

- File script bisa langsung di restore ke router

```
MMM      MMM      KKK      TTTTTTTTTTTT      KKK
MMMM     MMMM     KKK      TTTTTTTTTTTT      KKK
MMM MMMM  MMM  III  KKK  KKK  RRRRRR      000000      TTT      III  KKK  KKK
MMM  MM   MMM  III  KKKKK  RRR  RRR  000  000      TTT      III  KKKKK
MMM      MMM  III  KKK  KKK  RRRRRR      000  000      TTT      III  KKK  KKK
MMM      MMM  III  KKK  KKK  RRR  RRR  000000      TTT      III  KKK  KKK
```

MikroTik RouterOS 4.6 (c) 1999-2010

<http://www.mikrotik.com/>

```
[admin@MikroTik] > import route.rsc
Opening script file route.rsc

Script file loaded and executed successfully
[admin@MikroTik] >
```



DHCP Server

- Dynamic Host Configuration Protocol digunakan untuk secara dinamik mendistribusikan konfigurasi jaringan, seperti:
 - IP Address dan netmask
 - IP Address default gateway
 - Konfigurasi DNS dan NTP Server
 - Dan masih banyak lagi custom option (tergantung apakah DHCP client bisa support)

[LAB-10] DHCP Server (1)

The screenshot displays the Mikrotik WinBox interface. On the left, the navigation tree shows the 'DHCP Server' option circled in red. A red line connects this option to the 'DHCP Server' window. In this window, the 'DHCP' tab is selected and circled, and the 'DHCP Setup' button is also circled. A smaller 'DHCP Setup' dialog box is open in the foreground, showing 'ether1' selected in the 'DHCP Server Interface' dropdown menu. The background window shows a table with columns for Name, I. Relay, Lease Time, and Address Pool, currently containing 0 items.

[LAB-10] DHCP Server (2)

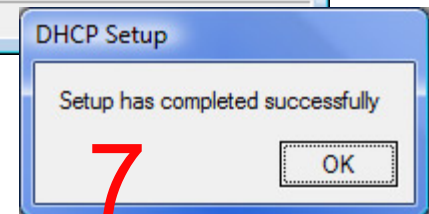
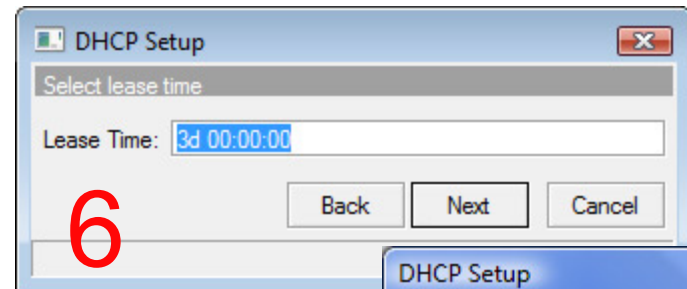
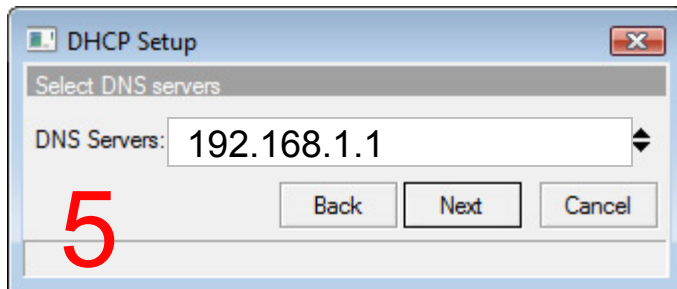
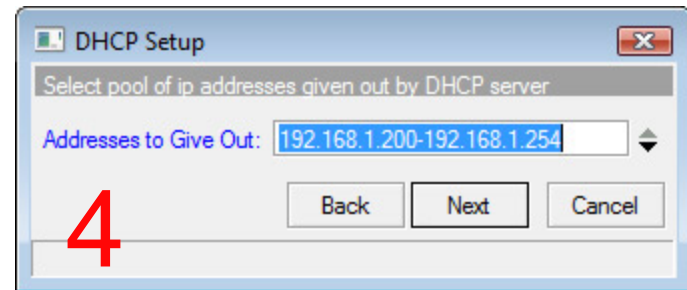
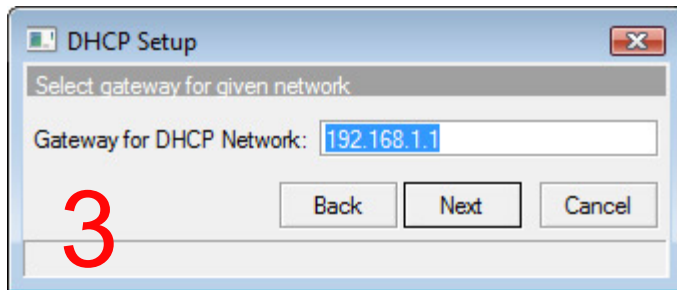
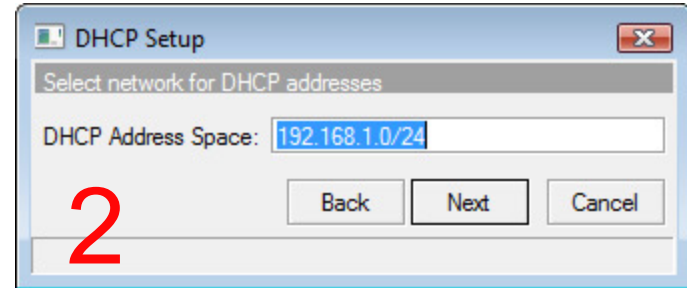
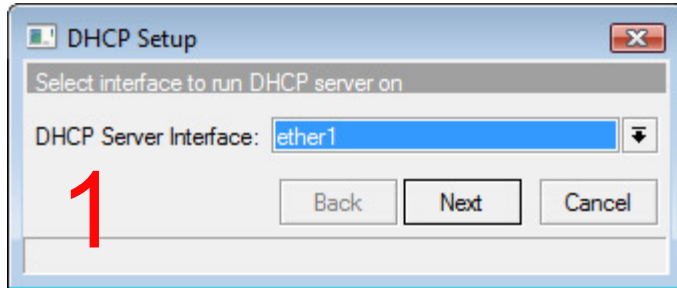

Terminal – DHCP Server Wizard

- Konfigurasi DHCP-Server setup
 - /ip dhcp-server setup
 - dhcp server interface: ether1
 - dhcp address space: 192.168.x.0/24
 - gateway for dhcp network: 192.168.x.1
 - dhcp relay: 192.168.x.1
 - addresses to give out: 192.168.x.10-192.168.x.20
 - dns servers: 192.168.x.1
 - lease time: 3d

DHCP Test

- Ubahlah konfigurasi IP Address dan DNS pada laptop menjadi otomatis
- Cek pada laptop apakah sudah mendapatkan alokasi IP Address dari DHCP
 - **C:\ ipconfig [enter]**
- Cobalah melakukan koneksi internet

DHCP Management

- Daftar DHCP client yang aktif terlihat pada menu **DHCP-Server – Leases**
- Untuk membuat IP Address tertentu hanya digunakan oleh Mac Address tertentu, bisa menggunakan **DHCP-Statik**

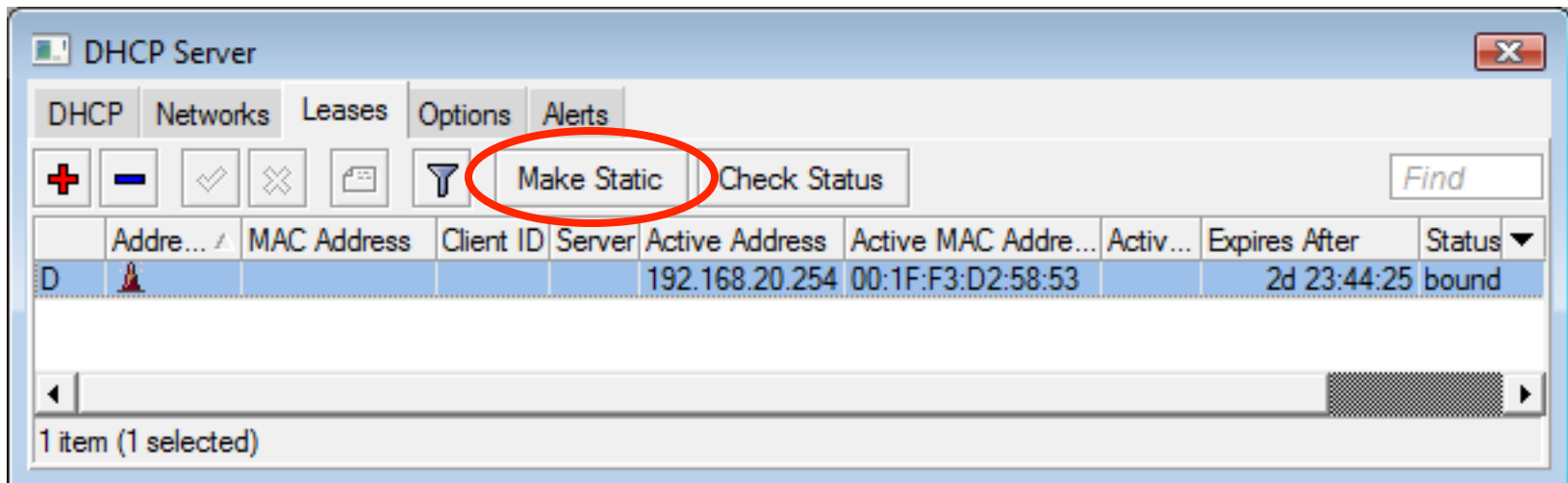

DHCP Static

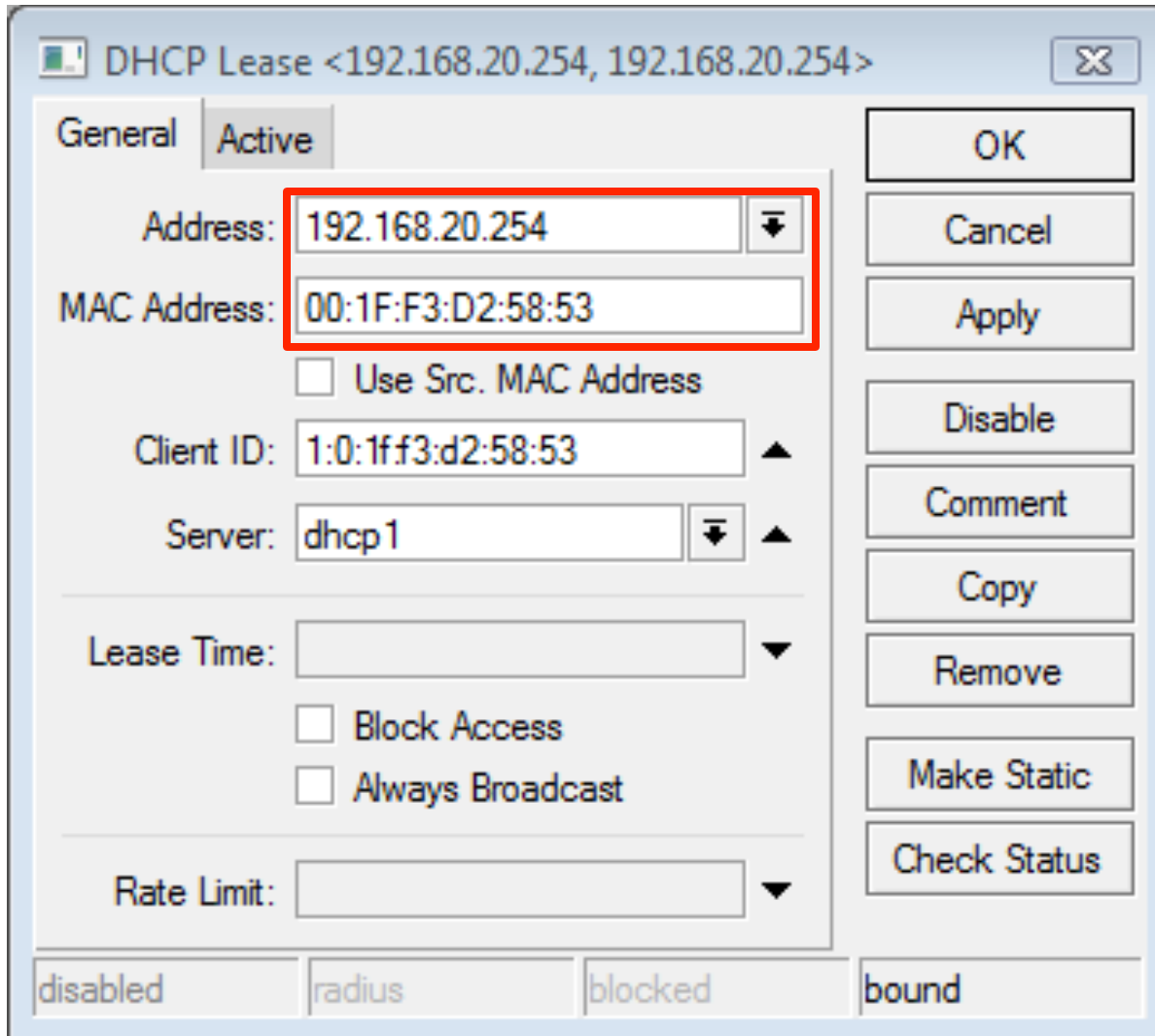

The image shows a screenshot of the Mikrotik DHCP Lease configuration window. The window title is "DHCP Lease <192.168.20.254, 192.168.20.254>". The "General" tab is selected, and the "Active" sub-tab is also selected. The "Address" field is highlighted with a red box and contains the value "192.168.20.254". The "MAC Address" field contains the value "00:1F:F3:D2:58:53". Below the MAC Address field, there is a checkbox labeled "Use Src. MAC Address" which is unchecked. The "Client ID" field contains the value "1:0:1ff3:d2:58:53". The "Server" field contains the value "dhcp1". The "Lease Time" field is empty. Below the Lease Time field, there are two checkboxes: "Block Access" (unchecked) and "Always Broadcast" (unchecked). The "Rate Limit" field is empty. On the right side of the window, there are several buttons: "OK", "Cancel", "Apply", "Disable", "Comment", "Copy", "Remove", "Make Static", and "Check Status". At the bottom of the window, there are four status indicators: "disabled", "radius", "blocked", and "bound".

General Active

Address: 192.168.20.254

MAC Address: 00:1F:F3:D2:58:53

Use Src. MAC Address

Client ID: 1:0:1ff3:d2:58:53

Server: dhcp1

Lease Time:

Block Access

Always Broadcast

Rate Limit:

OK

Cancel

Apply

Disable

Comment

Copy

Remove

Make Static

Check Status

disabled radius blocked bound



DHCP Client

- Dalam kondisi tertentu, IP Address yang diberikan oleh ISP yang akan dipasang pada router bukanlah IP Address statik, melainkan IP Address dinamis yang didapatkan melalui DHCP.
- Dalam kasus ini, kita bisa menggunakan fitur DHCP-Client.

[LAB-11] DHCP Client

The image shows a screenshot of the Mikrotik WinBox interface. On the left, a tree view shows the 'IP' menu expanded, with 'DHCP Client' selected. A red circle highlights 'IP' and another red circle highlights 'DHCP Client'. A red arrow points from the 'IP' circle to a '+' button in the 'DHCP Client' window. The 'DHCP Client' window shows an empty 'Interface' list. A second window, 'New DHCP Client', is open, showing the 'Interface' dropdown set to 'wlan1'. A red circle highlights the 'wlan1' selection. Below the interface field, three checkboxes are checked: 'Add Default Route', 'Use Peer DNS', and 'Use Peer NTP'. A red circle highlights these three checkboxes. The 'New DHCP Client' window also shows 'disabled' and 'stopped' status indicators at the bottom.

DHCP Client (1)

- **Interface**

- Pilihlah interface yang sesuai yang terkoneksi ke DHCP Server

- **Host name** *(tidak harus diisi)*

- Nama DHCP client yang akan dikenali oleh DHCP Server

- **Client ID** *(tidak harus diisi)*

- Biasanya merupakan mac-address interface yang kita gunakan, apabila proses DHCP di server menggunakan sistem radius



DHCP Client (2)

- **Add default route**
 - Bila kita menginginkan default route kita mengarah sesuai dengan informasi DHCP
- **Use Peer DNS**
 - Bila kita hendak menggunakan DNS server sesuai dengan informasi DHCP
- **Use Peer NTP**
 - Bila kita hendak menggunakan informasi pengaturan waktu di router (NTP) sesuai dengan informasi dari DHCP
- **Default route distance**
 - Menentukan prioritas routing jika terdapat lebih dari satu DHCP Server yang digunakan. Routing akan melalui distance yang lebih kecil

DHCP Client – Automatic Gateway

The screenshot shows the Mikrotik WinBox interface for a MikroTik RB333 router. The left sidebar contains a navigation menu with categories like Interfaces, Wireless, Bridge, PPP, IP, Routing, Ports, Queues, Drivers, System, Files, Log, SNMP, Users, Radius, Tools, New Terminal, Telnet, Password, Certificates, Make Supout.rif, Manual, and Exit. The main window displays two configuration windows: 'Address List' and 'Route List'. In the 'Address List' window, two entries are shown: 'D 20.20.20.254/24' and 'D 30.30.30.22/24'. The second entry is circled in red. In the 'Route List' window, the 'Routes' tab is active, showing a table of routes. The first row, 'DAS 0.0.0.0/0' with gateway '20.20.20.1' and interface 'ether2', is circled in red. The second row, 'DS 0.0.0.0/0' with gateway '30.30.30.1' and interface 'ether3', is also circled in red. The 'Route List' table has columns for Destination, Gateway, Gateway..., Interface, Distance, Routing Mark, and Pref. Source. The status bar at the bottom of the window indicates '4 items'.

Address	Network	Broadcast	Interface
20.20.20.254/24	20.20.20.0	20.20.20.255	ether2
30.30.30.22/24	30.30.30.0	30.30.30.255	ether3

Destination	Gateway	Gateway ...	Interface	Distance	Routing Mark	Pref. Source
DAS 0.0.0.0/0	20.20.20.1		ether2	5		
DS 0.0.0.0/0	30.30.30.1		ether3	10		
DAC 20.20.20.0/24			ether2	0		20.20.20.254
DAC 30.30.30.0/24			ether3	0		30.30.30.22

Internal User RouterOS

- Secara default, akan ada user admin dengan password [kosong]

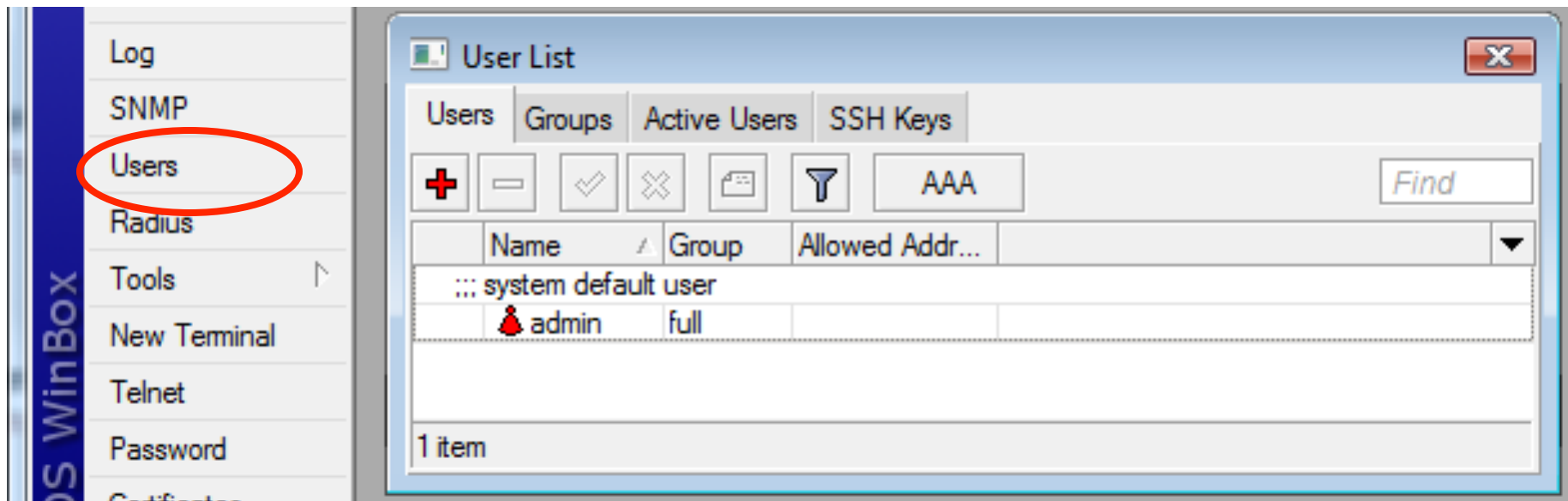

Internal User Groups

- User dapat dikategorikan hak nya berdasarkan grupnya.
- Kita bisa menambahkan user baru dengan hak tertentu.

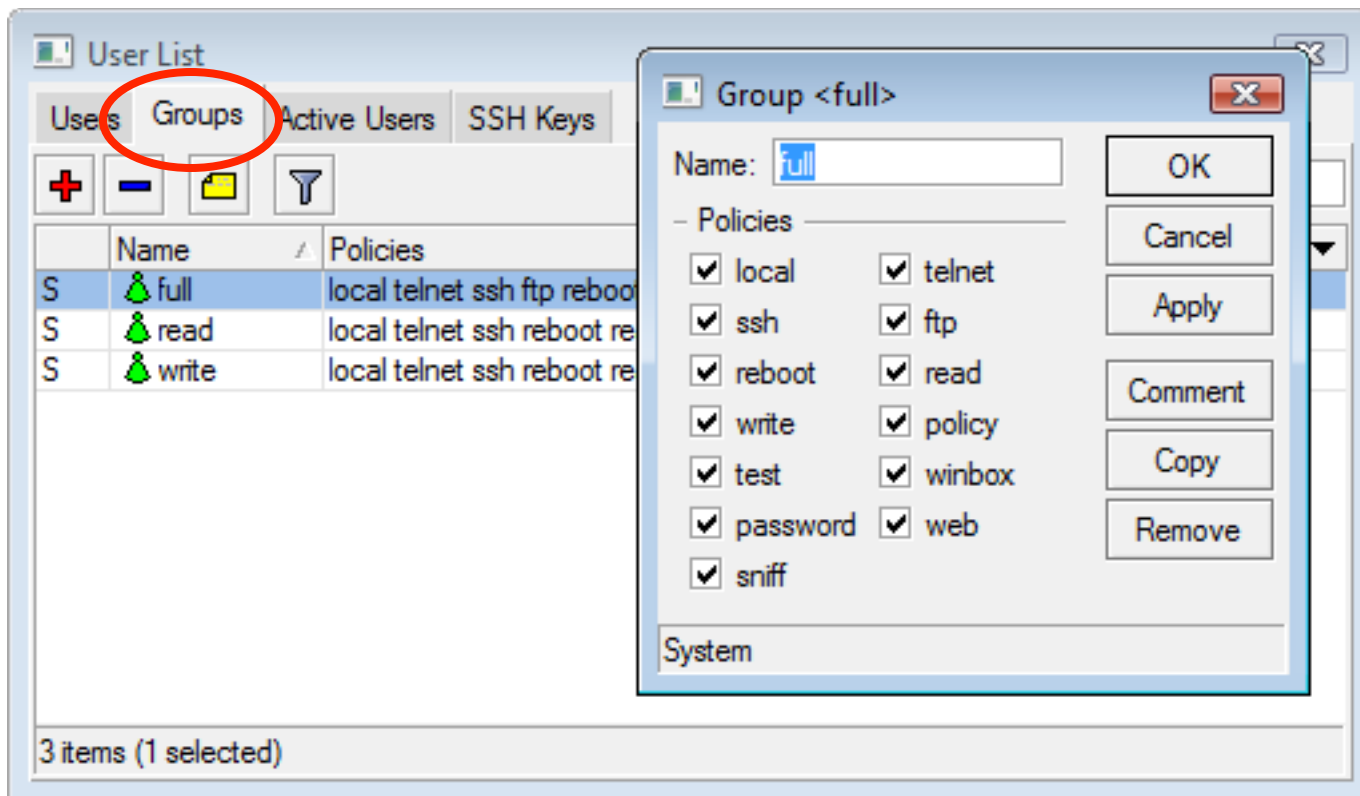

About User

- Buatlah user baru yang memiliki hak penuh dan non aktifkan user “**admin**”
- Untuk teknisi bisa diberikan grup **write** (bukan **full**) sehingga kita masih memiliki hak penuh terhadap router kita
- Untuk pemantauan, bisa menggunakan user dengan grup **read**

● ● ● | [LAB-12] Internal User

- Buat user tambahan untuk rekan semeja anda
- Buat grup beserta hak yang dimiliki
- Tentukan juga address yang diijinkan untuk mengakses router

Access to Router (IP Base)

- IP-Winbox
- Telnet
- SSH
- WebFig

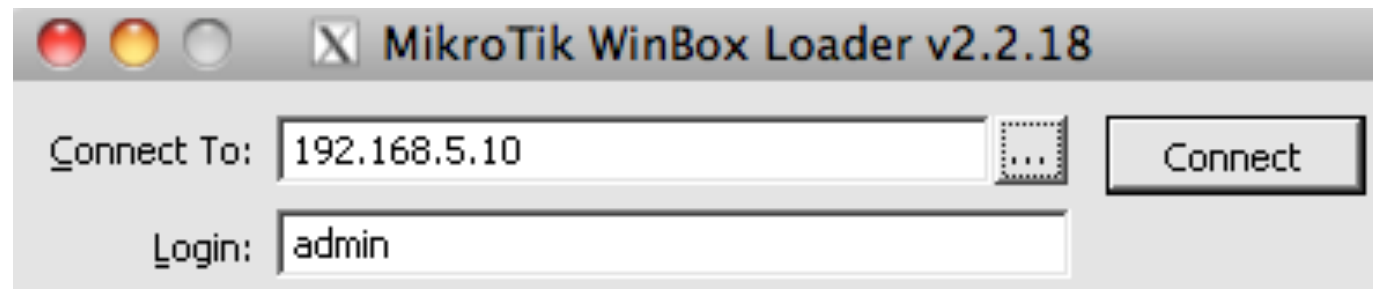

```
Novan-Chriss-MacBook-Pro:~ novan$ telnet 192.168.5.10
Trying 192.168.5.10...
Connected to 192.168.5.10.
Escape character is '^]'.
Password: █
```

Access to Router - WebFig

- Konfigurasi realtime berbasis Web memungkinkan konfigurasi mikrotik menggunakan perangkat mobile

RouterOS v5.2

You have connected to a router. Administrative access only. If this administrator.

Select action:



Winbox



Webfig



Telnet



Graphs



License

The server 192.168.5.1:80 at RouterOS requires a username and password.

User Name:

Password:

Cancel

Log In

Access to Router - WebFig

WebFig v5.2 MikroTik

Undo

Redo

Hide Passwords

Safe Mode

Log out

Interface List

Interface

Ethernet

EoIP Tunnel

IP Tunnel

GRE Tunnel

VLAN

VRRP

Bonding

Add New ▼

20 items

		▲ Name	Type	L2 MTU	Tx	Rx	Tx Pack	Rx Pack	Tx Drop	Rx Dro	Tx Erro	Rx Erro
-	D	D	<pptp-0>	PPTP Server		0 bps	0 bps	0	0	0	0	0
-	D	R	bridge-local	Bridge	1520	88.8 kbps	0 bps	50	0	0	0	0
-	D	R	bridge-public	Bridge	1520	0 bps	0 bps	0	0	0	0	0
-	D	R	eoip-ke-jogja	EoIP Tunnel	65535	0 bps	0 bps	0	0	0	0	0
-	E	X	eoip-to-larangan	EoIP Tunnel		0 bps	0 bps	0	0	0	0	0
-	D	R	eoip-to-rajawali	EoIP Tunnel	65535	0 bps	0 bps	0	0	0	0	0
-	E	X	eoip-to-wonocati	EoIP Tunnel		0 bps	0 bps	0	0	0	0	0
	D	R	ether1	Ethernet	1524	0 bps	88.8 kbps	0	50	0	0	0
	D	R	ether2	Ethernet	1524	91.2 kbps	0 bps	50	0	0	0	0

Address Resolution Protocol

- Untuk memetakan OSI level 3 IP address ke OSI level 2 MAC address
- Digunakan dalam transport data antara host dengan router

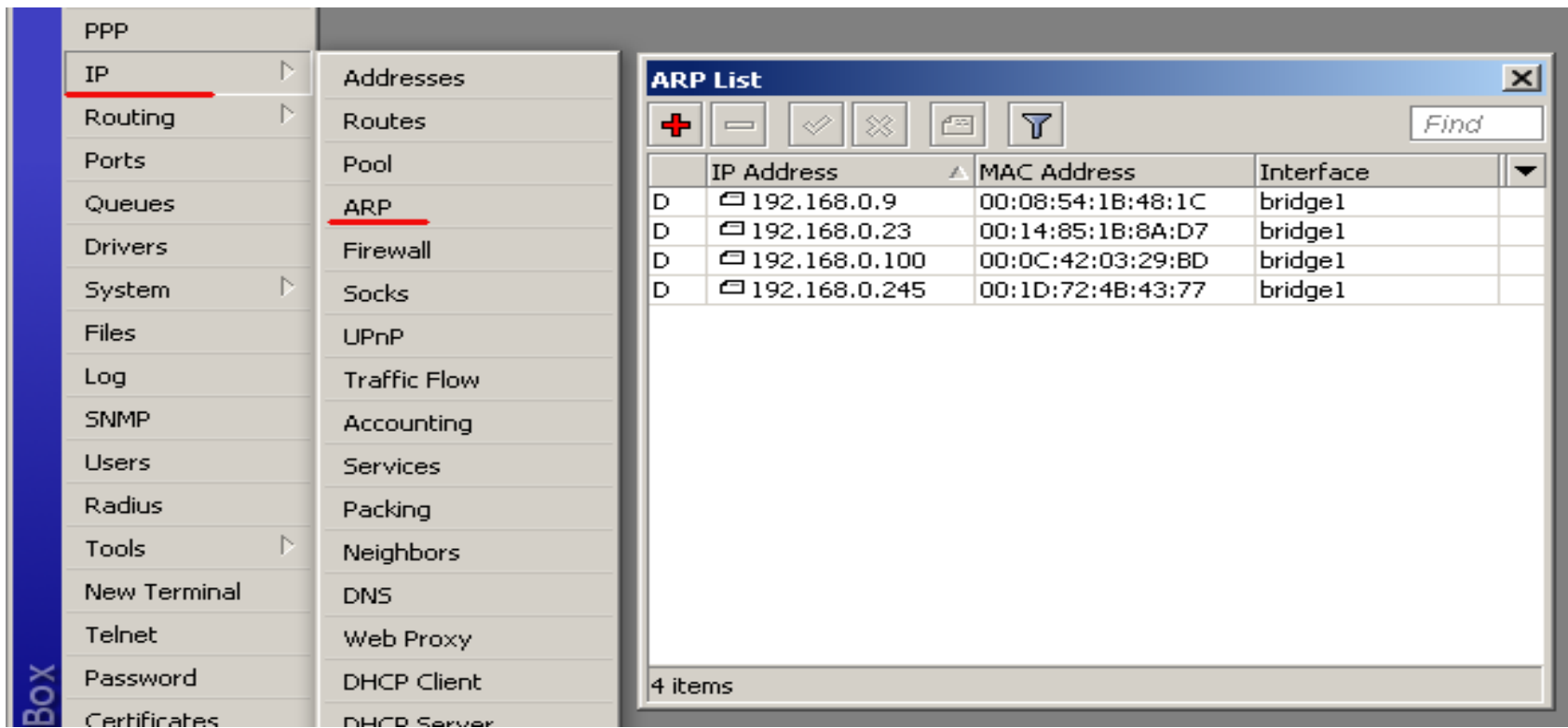

The screenshot shows the Mikrotik WinBox interface. On the left, the 'IP' menu is expanded, and 'ARP' is selected. The main window displays the 'ARP List' window, which contains a table of ARP entries. The table has four columns: 'IP Address', 'MAC Address', and 'Interface'. There are four entries listed, each with a status 'D' in the first column.

	IP Address	MAC Address	Interface
D	192.168.0.9	00:08:54:1B:48:1C	bridge1
D	192.168.0.23	00:14:85:1B:8A:D7	bridge1
D	192.168.0.100	00:0C:42:03:29:BD	bridge1
D	192.168.0.245	00:1D:72:4B:43:77	bridge1

4 items

ARP Protocol

- ARP protocol secara “default” aktif di setiap interface.
- ARP = Enabled – menandakan Interface akan mengupdate tabel ARP secara otomatis

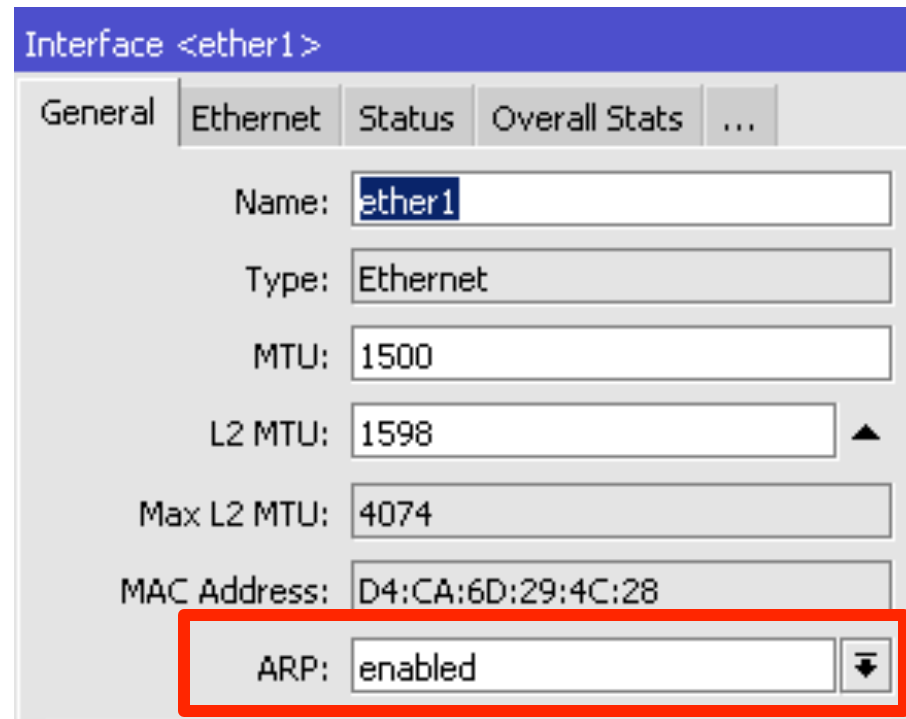

Interface <ether1>

General | Ethernet | Status | Overall Stats | ...

Name: ether1

Type: Ethernet

MTU: 1500

L2 MTU: 1598 ▲

Max L2 MTU: 4074

MAC Address: D4:CA:6D:29:4C:28

ARP: enabled ▼

ARP – Security !

- ARP = Reply-only – menandakan ARP protocol pada interface tidak mengupdate data di ARP table secara otomatis.

The screenshot displays two windows from Mikrotik WinBox. The 'ARP List' window shows a table of existing entries and a 'New ARP' form. The 'Interface <ether1>' window shows configuration details for the ether1 interface, with the 'ARP' dropdown menu set to 'reply-only'.

	IP Address	MAC Address	Int
D	192.168.10.240	D8:A2:5E:8C:00:B9	bri
D	192.168.10.242	D8:5D:4C:94:BC:45	bri
D	202.65.113.145	00:0C:42:41:C2:4A	vla

New ARP

IP Address: 192.168.123.4
MAC Address: AA:BB:CC:DD:EE:FF
Interface: ether1

Interface <ether1>

General | Ethernet | Status | Overall Stats | ...

Name: ether1
Type: Ethernet
MTU: 1500
L2 MTU: 1598
Max L2 MTU: 4074
MAC Address: D4:CA:6D:29:4C:28
ARP: reply-only

Monitoring - Ping

- Tool monitoring

- Ping

- Ping uses Internet Control Message Protocol (ICMP) Echo messages to determine if a remote host is active or inactive and to determine the round-trip delay when communicating with it.

```
[user1@MKI] > ping 192.168.0.100
```

```
192.168.0.100 64 byte ping: ttl=64 time=1 ms
```

```
192.168.0.100 64 byte ping: ttl=64 time=1 ms
```

```
192.168.0.100 64 byte ping: ttl=64 time=1 ms
```

```
3 packets transmitted, 3 packets received, 0% packet loss
```

```
round-trip min/avg/max = 1/1.0/1 ms
```

Monitoring – Ping Flood

- Flood Ping



Field	Value
Flood Ping To:	192.168.0.22
Packet Count:	1000
Packet Size:	1500
Timeout:	1000
<hr/>	
Packets Sent:	1000
Packets Received:	1000
Minimum RTT:	1
Average RTT:	1
Maximum RTT:	4

Monitoring - Traceroute

Traceroute

- Traceroute determines how packets are being routed to a particular host
- We can choose the protocol : ICMP or UDP

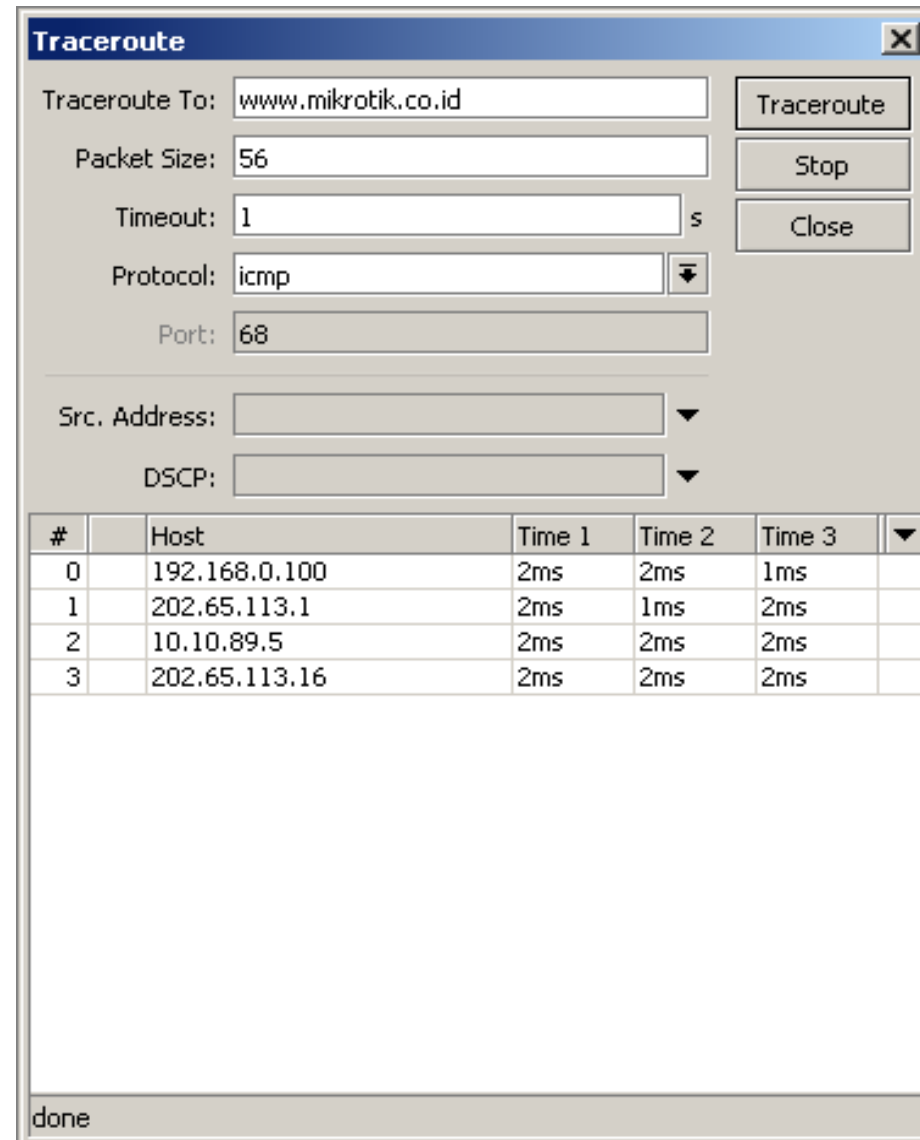

The screenshot shows the Traceroute utility window with the following configuration:

- Traceroute To:
- Packet Size:
- Timeout: s
- Protocol:
- Port:
- Src. Address:
- DSCP:

Buttons: Traceroute, Stop, Close

#	Host	Time 1	Time 2	Time 3
0	192.168.0.100	2ms	2ms	1ms
1	202.65.113.1	2ms	1ms	2ms
2	10.10.89.5	2ms	2ms	2ms
3	202.65.113.16	2ms	2ms	2ms

done

Monitoring - Torch

- Torch - Realtime traffic monitor

The screenshot shows the Mikrotik Torch (running) window. It is divided into several sections:

- Basic:** Interface: ether7, Entry Timeout: 00:00:03 s.
- Filters:** Src. Address: 0.0.0.0/0, Dst. Address: 0.0.0.0/0, Protocol: any, Port: any, VLAN Id: any.
- Collect:** Src. Address, Dst. Address, VLAN Id, Protocol, Port.
- Buttons:** Start, Stop, Close.
- Find:** A search bar with the text "Find".
- Table:** A table displaying real-time traffic monitoring data.

	Protocol	Src. Address	Src. Port	Dst. Address	Dst. Port	Tx Rate	Rx Rate	Tx Pack...	Rx Pack...	
	6 (tcp)	192.168.5.215	62381	192.168.5.10	8291 (winbox)	45.0 kbps	5.5 kbps	6	9	
	17 (udp)	192.168.5.215	51413	123.237.86.2	60203	1365 bps	65.7 kbps	3	6	
	17 (udp)	192.168.5.215	51413	117.199.1.58	38556	928 bps	51.1 kbps	2	5	
	17 (udp)	192.168.5.215	51413	184.74.34.15	12046	901 bps	6.0 kbps	1	1	
	17 (udp)	192.168.5.215	51413	67.242.132.53	31319	128 bps	637 bps	0	0	
	6 (tcp)	192.168.5.215	49346	58.179.43.56	24443	0 bps	3.8 kbps	0	0	
	17 (udp)	192.168.5.215	51413	173.25.84.47	34585	501 bps	6.1 kbps	1	1	
	6 (tcp)	192.168.5.215	49361	60.241.80.137	6881	277 bps	2.3 kbps	0	0	
	17 (udp)	192.168.5.215	51413	193.146.87.165	45007	1001 bps	7571 bps	0	0	

Monitoring - Resource

- Resource
 - To monitor the System.
 - Detail Resource monitor located on right side buttons

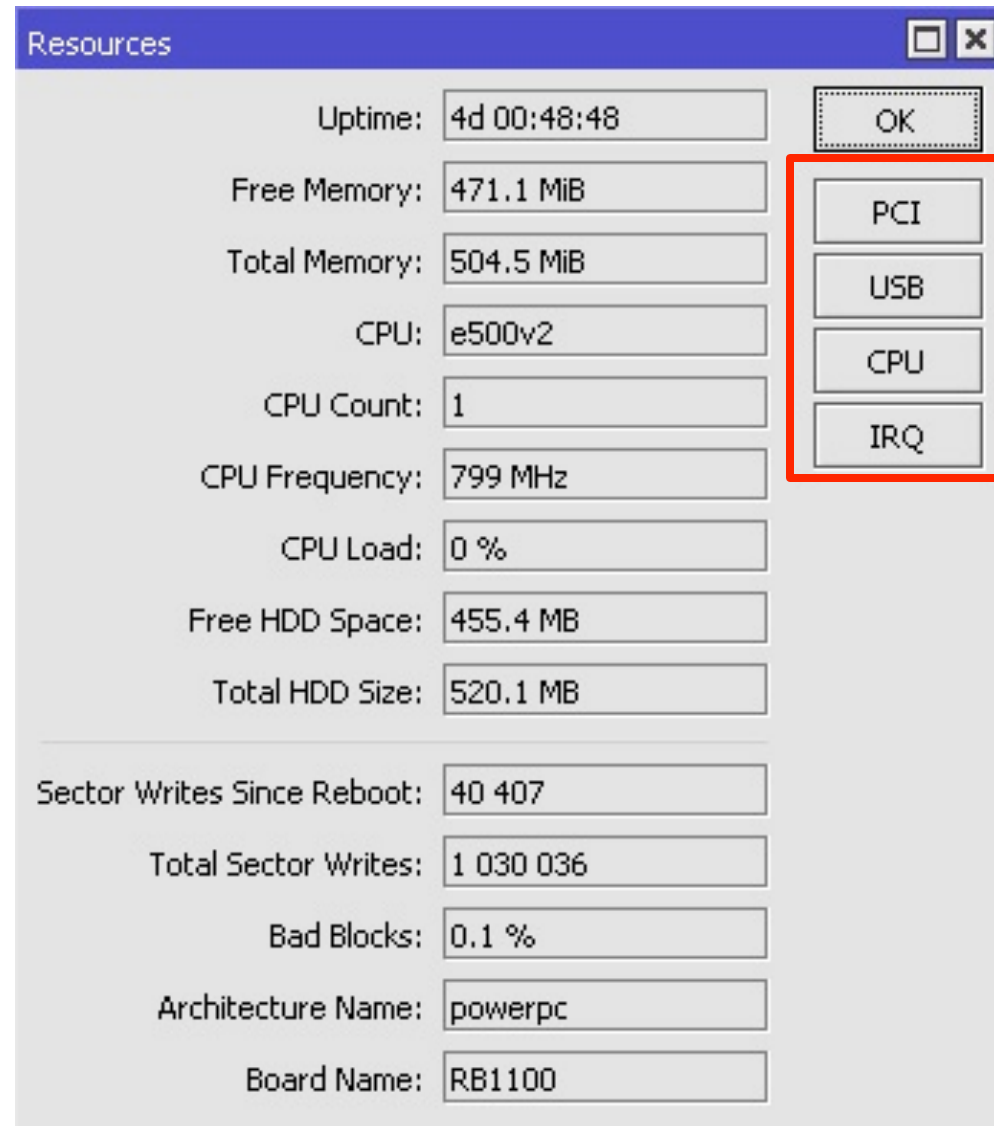

Resources

Uptime:	4d 00:48:48	OK
Free Memory:	471.1 MiB	PCI
Total Memory:	504.5 MiB	USB
CPU:	e500v2	CPU
CPU Count:	1	IRQ
CPU Frequency:	799 MHz	
CPU Load:	0 %	
Free HDD Space:	455.4 MB	
Total HDD Size:	520.1 MB	
Sector Writes Since Reboot:	40 407	
Total Sector Writes:	1 030 036	
Bad Blocks:	0.1 %	
Architecture Name:	powerpc	
Board Name:	RB1100	

Monitoring – CPU Load

- Tool – Profile untuk monitoring CPU Load

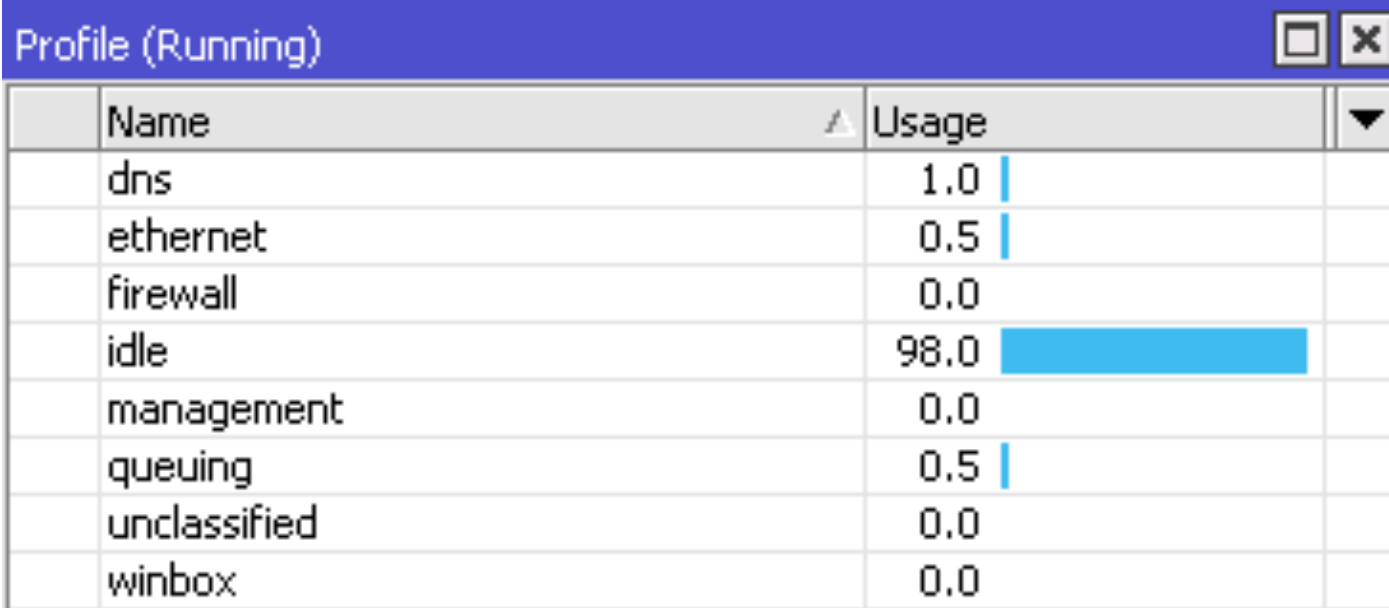

Name	Usage
dns	1.0
ethernet	0.5
firewall	0.0
idle	98.0
management	0.0
queuing	0.5
unclassified	0.0
winbox	0.0



Basic TCP/IP



Certified Mikrotik Training Basic Class

Organized by: Citraweb Nusa Infomedia

(Mikrotik Certified Training Partner)



Training Outline

- OSI Layer
- Packet Header
- Mac Address
- IP Address and subnetting
- IP Protocol
- Basic networking, DNS, gateway

Internet Topologi

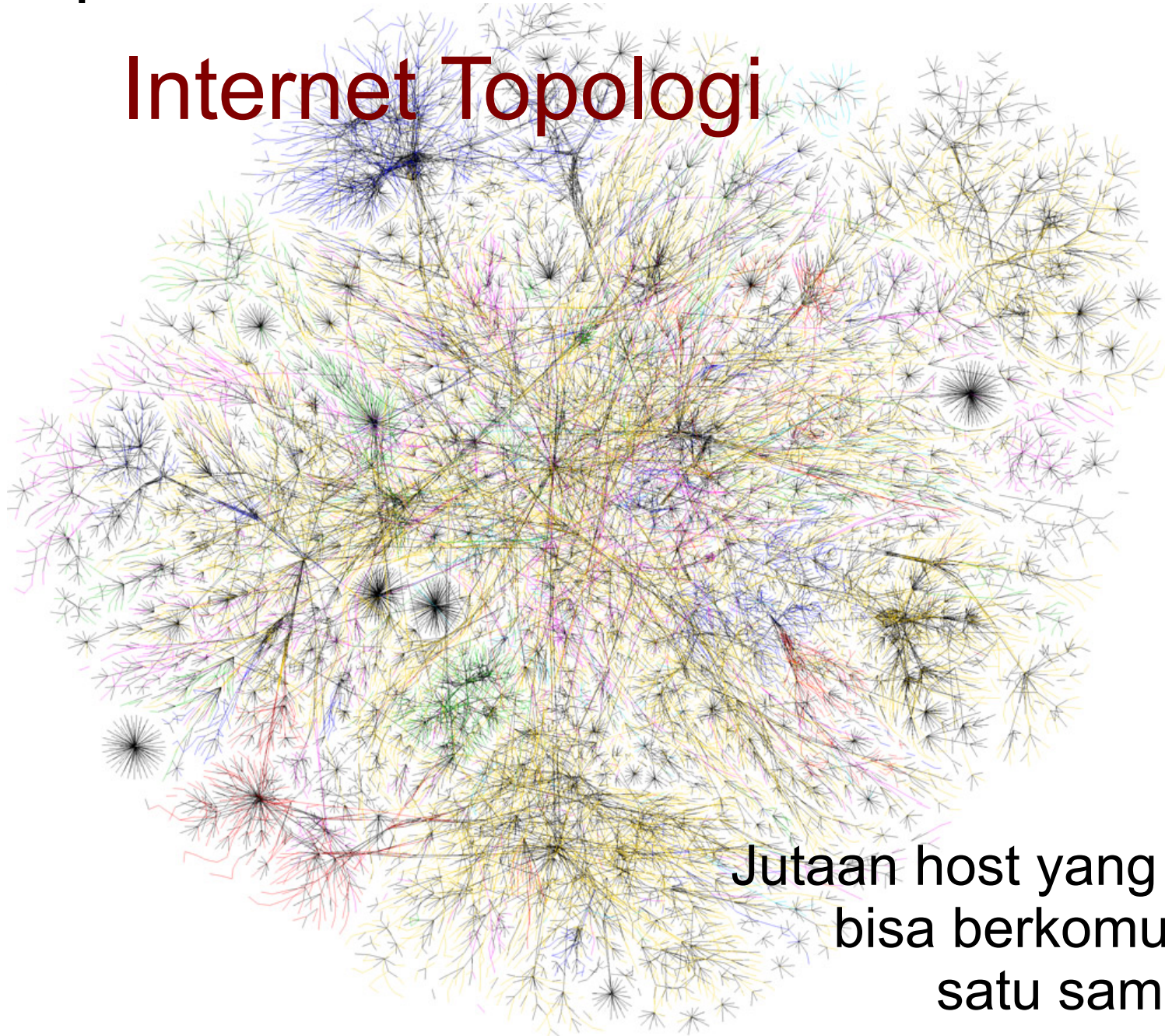

Jutaan host yang harus
bisa berkomunikasi
satu sama lain.

OSI Layer dan Protokol

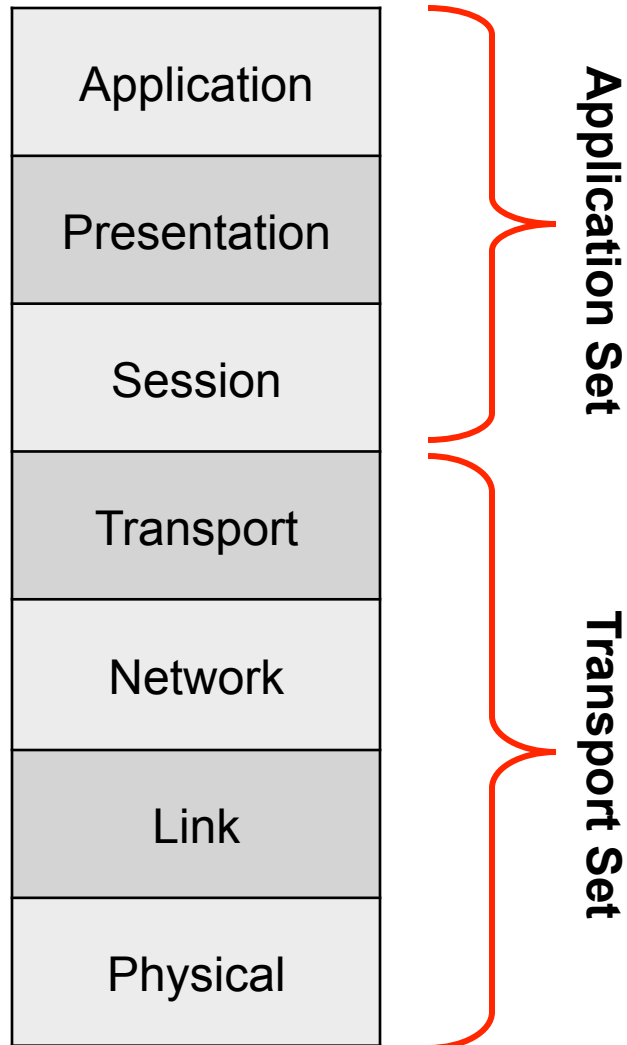

Open Systems Interconnection (OSI) adalah sebuah model referensi arsitektur antarmuka jaringan yang dikembangkan oleh ISO yang kemudian menjadi konsep standard komunikasi jaringan di hampir semua perangkat jaringan.

OSI Layer dan Protokol

Application	SMTP	HTTP	FTP	Telnet	DNS	DHCP	SNMP	TFTP
Presentation	Enkripsi, dekripsi, mime							
Session	TCP Data Session Maintenance				Domain Resolve			
Transport	TCP Transmission Control Protocol				UDP User Datagram Protocol			
Network	IP						Routing Protocols RIP, OSPF, BGP	
	ICMP							
Link	Mac Address, Switch							ARP
Physical	Ethernet, Wireless, ATM, Frame Relay, PPP							

Packet Header

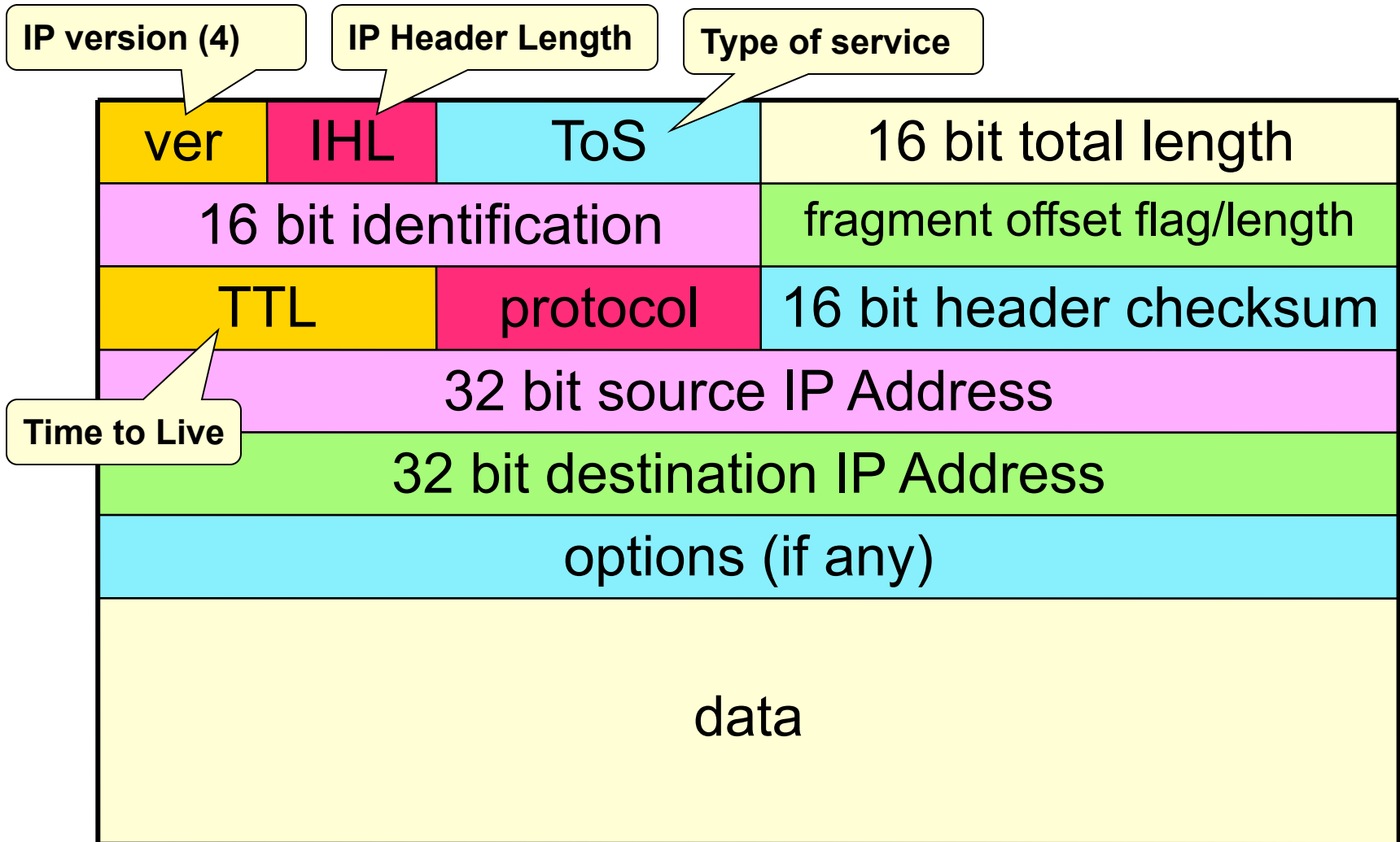

MAC Address

- MAC = Media Access Control
- Digunakan sebagai identitas yang unik dari setiap interface hardware, yang merupakan identitas untuk berkomunikasi di OSI layer 2.
- Sebagian bit merupakan identitas pabrik pembuat hardware
- 48 bit hex. Contoh: “**AA:BB:CC:DD:EE:FF**”
- Jika sebuah router memiliki 3 interface fisik, maka akan memiliki 3 buah mac address
- Untuk virtual interface (VLAN, EoIP) maka ditambahkan mac address virtual.

ARP Table

- Merupakan protokol penghubung antara layer **2 data-link** dan **3 network**.
- ARP Table di router merupakan daftar **host yang terhubung langsung** berisi informasi pasangan **mac address** dan **ip address**.
- Di **IPv6** arp digantikan dengan **NDP** (Network Discovery Protocol).

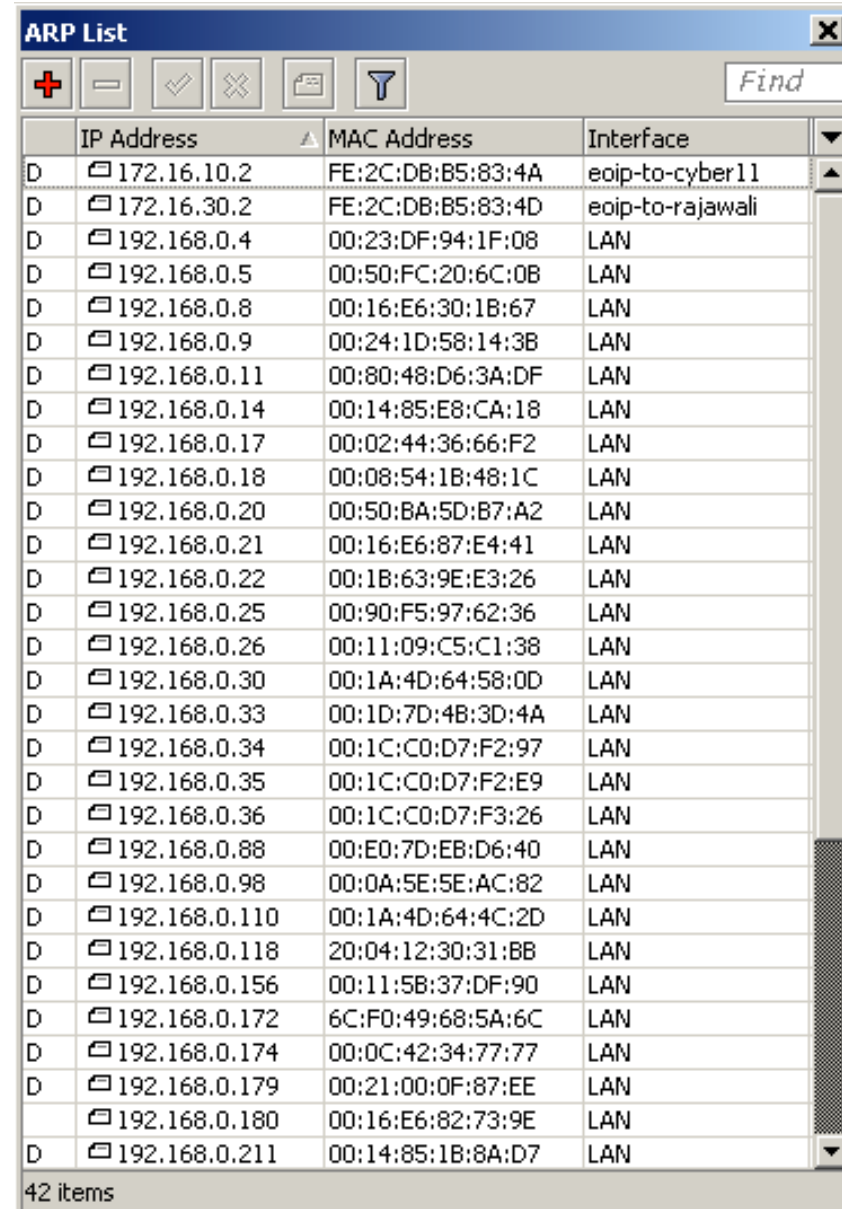

The screenshot shows the 'ARP List' window in Mikrotik WinBox. The window title is 'ARP List' and it has a search bar labeled 'Find'. The table below lists 42 items, each with an IP Address, MAC Address, and Interface.

	IP Address	MAC Address	Interface
D	172.16.10.2	FE:2C:DB:B5:83:4A	eoip-to-cyber11
D	172.16.30.2	FE:2C:DB:B5:83:4D	eoip-to-rajawali
D	192.168.0.4	00:23:DF:94:1F:08	LAN
D	192.168.0.5	00:50:FC:20:6C:0B	LAN
D	192.168.0.8	00:16:E6:30:1B:67	LAN
D	192.168.0.9	00:24:1D:58:14:3B	LAN
D	192.168.0.11	00:80:48:D6:3A:DF	LAN
D	192.168.0.14	00:14:85:E8:CA:18	LAN
D	192.168.0.17	00:02:44:36:66:F2	LAN
D	192.168.0.18	00:08:54:1B:48:1C	LAN
D	192.168.0.20	00:50:BA:5D:B7:A2	LAN
D	192.168.0.21	00:16:E6:87:E4:41	LAN
D	192.168.0.22	00:1B:63:9E:E3:26	LAN
D	192.168.0.25	00:90:F5:97:62:36	LAN
D	192.168.0.26	00:11:09:C5:C1:38	LAN
D	192.168.0.30	00:1A:4D:64:58:0D	LAN
D	192.168.0.33	00:1D:7D:4B:3D:4A	LAN
D	192.168.0.34	00:1C:C0:D7:F2:97	LAN
D	192.168.0.35	00:1C:C0:D7:F2:E9	LAN
D	192.168.0.36	00:1C:C0:D7:F3:26	LAN
D	192.168.0.88	00:E0:7D:EB:D6:40	LAN
D	192.168.0.98	00:0A:5E:5E:AC:82	LAN
D	192.168.0.110	00:1A:4D:64:4C:2D	LAN
D	192.168.0.118	20:04:12:30:31:BB	LAN
D	192.168.0.156	00:11:5B:37:DF:90	LAN
D	192.168.0.172	6C:F0:49:68:5A:6C	LAN
D	192.168.0.174	00:0C:42:34:77:77	LAN
D	192.168.0.179	00:21:00:0F:87:EE	LAN
	192.168.0.180	00:16:E6:82:73:9E	LAN
D	192.168.0.211	00:14:85:1B:8A:D7	LAN

42 items

IP Address

- o Adalah sistem pengalamatan setiap host yang terhubung ke jaringan
- o Saat ini IP Address yang banyak digunakan adalah IP versi 4. (32 bits / 4 bytes) - 4,294,967,296 hosts

An IPv4 address (dotted-decimal notation)

172 . 16 . 254 . 1



10101100 , 00010000 , 11111110 , 00000001



One byte = Eight bits



Thirty-two bits ($4 * 8$), or 4 bytes

Pengelompokan IP Address

- Pengelompokan IP Address dilakukan dengan subnet-ing.
- Subnet 0 – 32
 - Melambangkan jumlah IP dalam subnet tersebut dengan rumus $2^{(32-x)}$
 - Subnet 0 berarti semua IP Address
 - Subnet 32 berarti 1 IP Address

IP Subneting (contoh 1)

- o Contoh: 192.168.0.0/24
 - Netmask : 255.255.255.0
 - Prefix : /24
 - IP Network : 192.168.0.0
 - First HostIP: 192.168.0.1
 - Last HostIP: 192.168.0.254
 - Broadcast : 192.168.0.255
 - HostIP : total IP di dalam Subnet (–) minus 2

IP Subneting (contoh 2)

- o Contoh: 192.168.0.0/25
 - Netmask : 255.255.255.128
 - Prefix : /25
 - IP Network : 192.168.0.0
 - First HostIP: 192.168.0.1
 - Last HostIP: 192.168.0.126
 - Broadcast : 192.168.0.127
 - HostIP : total IP di dalam Subnet (–) minus 2

Tabel Subnet

Subnet Mask	Prefix	No of IP	Usable IP
255.255.255.0	/24	256	254
255.255.255.128	/25	128	126
255.255.255.192	/26	64	62
255.255.255.224	/27	32	30
255.255.255.240	/28	16	14
255.255.255.248	/29	8	6
255.255.255.252	/30	4	2
255.255.255.254	/31	2	-
255.255.255.255	/32	1	-

Public and Private IP Address

o **Public IP Address**

IP Address yang dapat diakses di jaringan internet.
Kita bisa mendapatkan Public IP Address dari:

- o Dipinjami dari ISP
- o Alokasi dari APNIC/IDNIC (www.idnic.net)

o **Private IP Address**

IP Address yang diperuntukkan untuk jaringan lokal (tidak dapat diakses di jaringan internet)

- o 10.0.0.0 – 10.255.255.255 (10./8)
- o 172.16.0.0 – 172.31.255.255 (172.16./12)
- o 192.168.0.0 – 192.168.255.255 (192.168./16)

IP Address Khusus Lainnya

Penggunaan	IP / subnet
Self Identification	0.0.0.0/8
Localhost	127.0.0.1
Not Used	Other 127.0.0.0/8
Multicast	224.0.0.0/4
Local link/DHCP error	169.245.0.0/16
TEST-NET-1	192.0.2.0/24
TEST-NET-2	198.51.100.0/24
TEST-NET-3	203.0.113.0/24
6to4 Relay Anycast	192.88.99.0/24
Benchmark Test	198.18.0.0/15
Future Used	240.0.0.0/4
Limited Broadcast	255.255.255.255/32

RFC5735 Jan 2010: <http://tools.ietf.org/html/rfc5735>



IP Protocol

- Adalah protokol standart yang digunakan untuk mengkomunikasikan data melalui berbagai jenis perangkat dan layer.
- Pengiriman data dilakukan dengan sistem “per paket” dan/atau “per connection” .
- Sistem ini menjamin keutuhan data, dan mencegah terjadinya kekurangan ataupun duplikasi data.
- Ada beragam protokol yang biasa digunakan, yang umum adalah TCP, UDP, dan ICMP.

ICMP (Internet Control Message Protocol)

- Disalurkan berbasis “best effort” sehingga bisa terjadi error (datagram lost)
- Banyak digunakan untuk pengecekan jaringan
- Prinsip kerja:
 - Host (router ataupun tujuan) akan mendeteksi apabila terjadi permasalahan tranmisi, dan membuat “ICMP message” yang akan dikirimkan ke host asal.
- Aplikasi ICMP yang paling banyak digunakan: Ping dan Traceroute

Type	Name
0	Echo Reply
1	Unassigned
2	Unassigned
3	Destination Unreachable
4	Source Quench
5	Redirect
6	Alternate Host Address
7	Unassigned
8	Echo
9	Router Advertisement
10	Router Solicitation
11	Time Exceeded

● ● ● | UDP (User Datagram Protocol)

- Komputer yang satu bisa mengirimkan pesan/ datagram ke komputer lainnya di jaringan, tanpa terlebih dahulu melakukan “hand-shake” (connectionless communication)
- Biasanya digunakan untuk servis yang mengirimkan data kecil ke banyak host
- Tidak ada flow control ataupun mekanisme lain untuk menjaga keutuhan datagram
- Aplikasi yang paling umum menggunakan UDP adalah DNS dan berbagai game online



TCP (Transmission Control Protocol)

- Merupakan protokol yang paling banyak digunakan di internet.
- Bekerja dengan pengalamatan port
 - Port 1 – 1024 : low port (standard service port)
 - Port 1025...: high port (untuk transmisi lanjutan)
- Contoh aplikasi: http, email, ftp, dll
- Prinsip Kerja: Connection Oriented, Reliable Transmission, Error Detection, Flow Control, Segment Size Control, Congestion Control

Prinsip Kerja TCP

- Connection Oriented
 - Koneksi diawali dengan proses “handshake”
 - Client → SYN → Server
 - Server → SYN-ACK → Client
 - Client → ACK → Server
 - Reliable Transmission
 - Mampu melakukan pengurutan paket data, setiap byte data ditandai dengan nomor yang unik
 - Error Detection
 - Jika terjadi error, bisa dilakukan pengiriman ulang data



Prinsip Kerja TCP

- Flow Control
 - Mendeteksi supaya satu host tidak mengirimkan data ke host lainnya terlalu cepat
- Segment Size Control
 - Mendeteksi besaran MSS (maximum segment size) yang bisa dikirimkan supaya tidak terjadi IP fragmentation
- Congestion Control
 - TCP menggunakan beberapa mekanisme untuk mencegah terjadinya congestion pada network

Konsep Dasar Jaringan

- o Host yang memiliki IP Address dari subnet yang sama bisa terkoneksi langsung, tanpa melalui router
- o From : **192.168.0.4** To : **192.168.0.26**

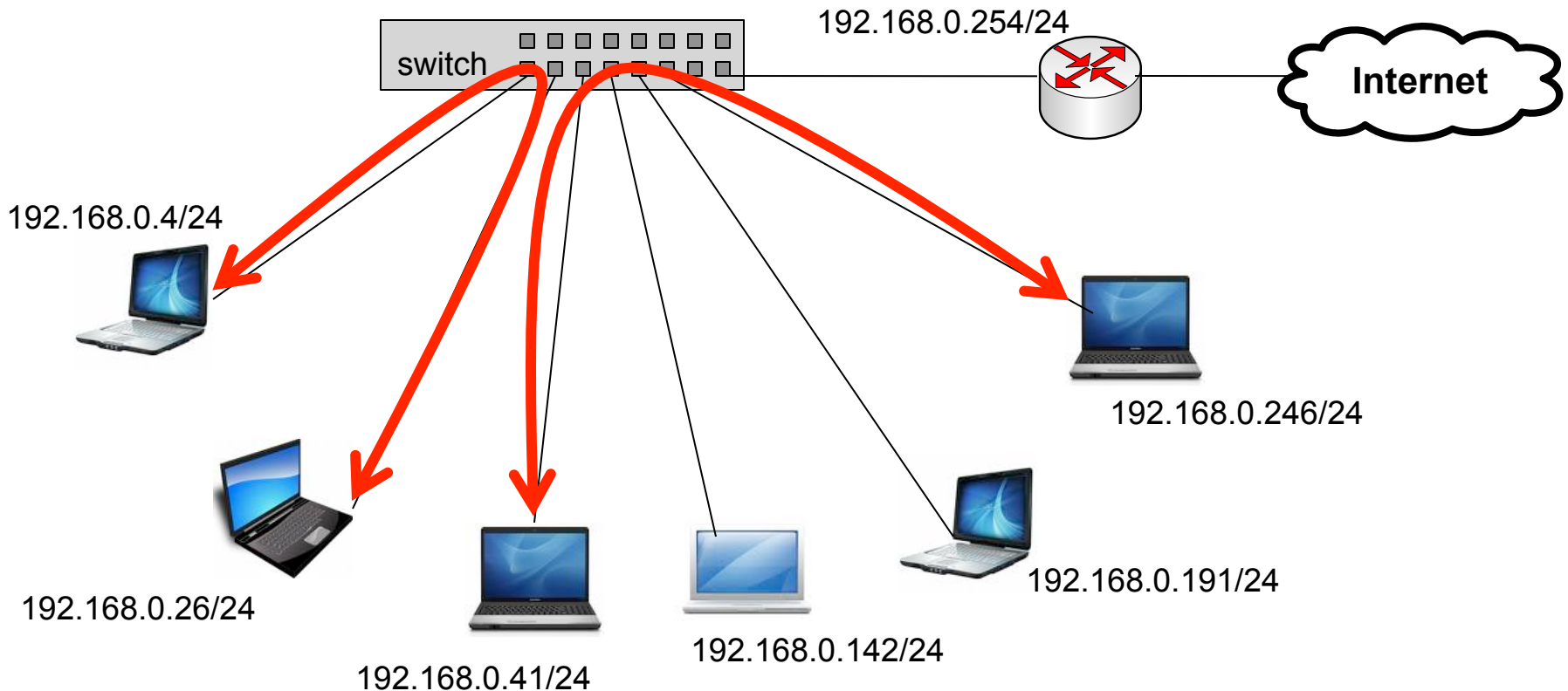

Konsep Dasar Jaringan

- Router bertugas untuk menghubungkan dua atau lebih jaringan yang memiliki subnet yang berbeda

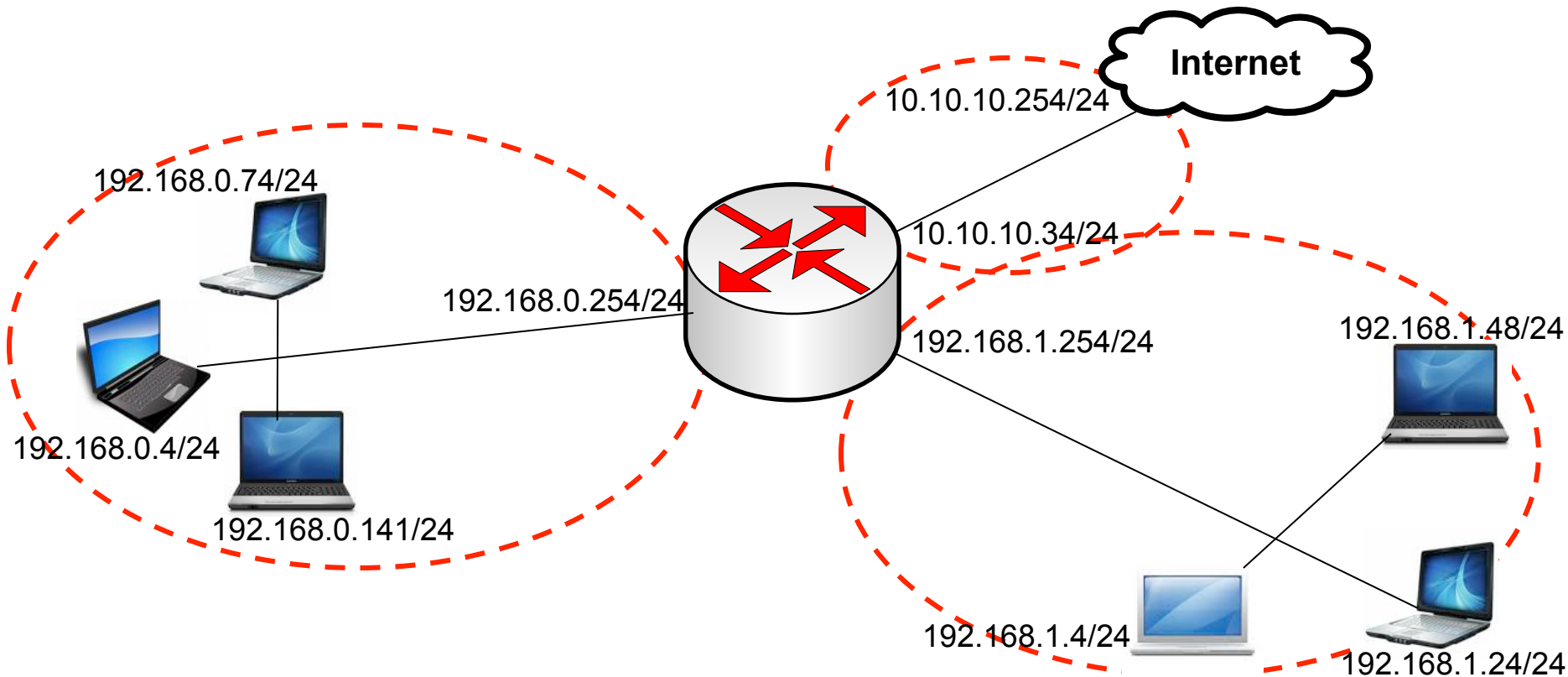

Konsep Dasar Jaringan

- o Dua buah IP Address yang berasal dari subnet yang sama tidak boleh dipasang pada dua buah interface yang berbeda pada sebuah router

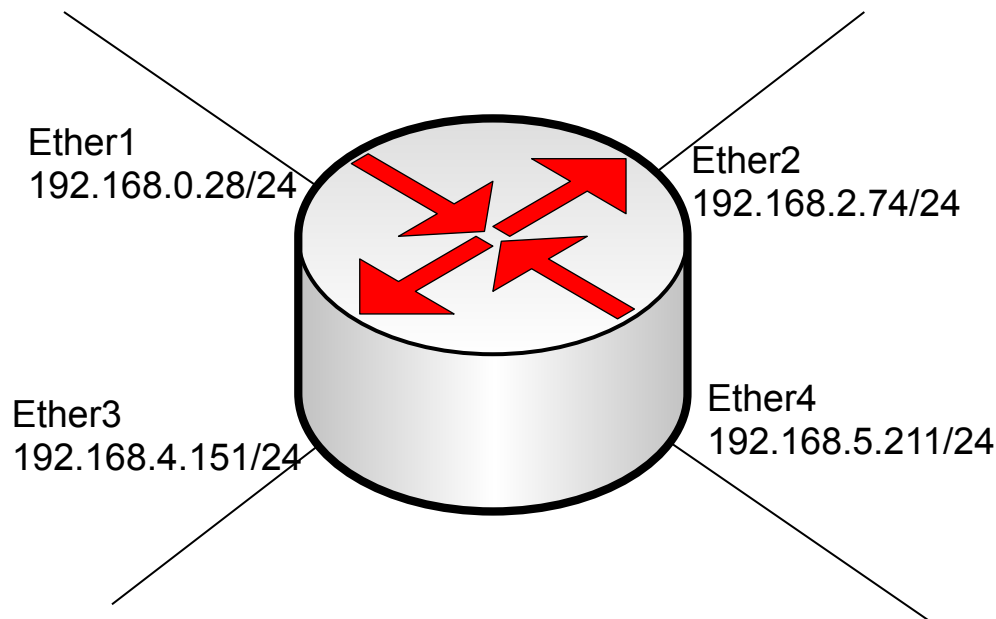

Konsep Dasar Jaringan

- **Default gateway** menentukan ke arah mana trafik harus disalurkan untuk menuju ke internet
 - From : **192.168.0.142** To : **222.24.112.34**

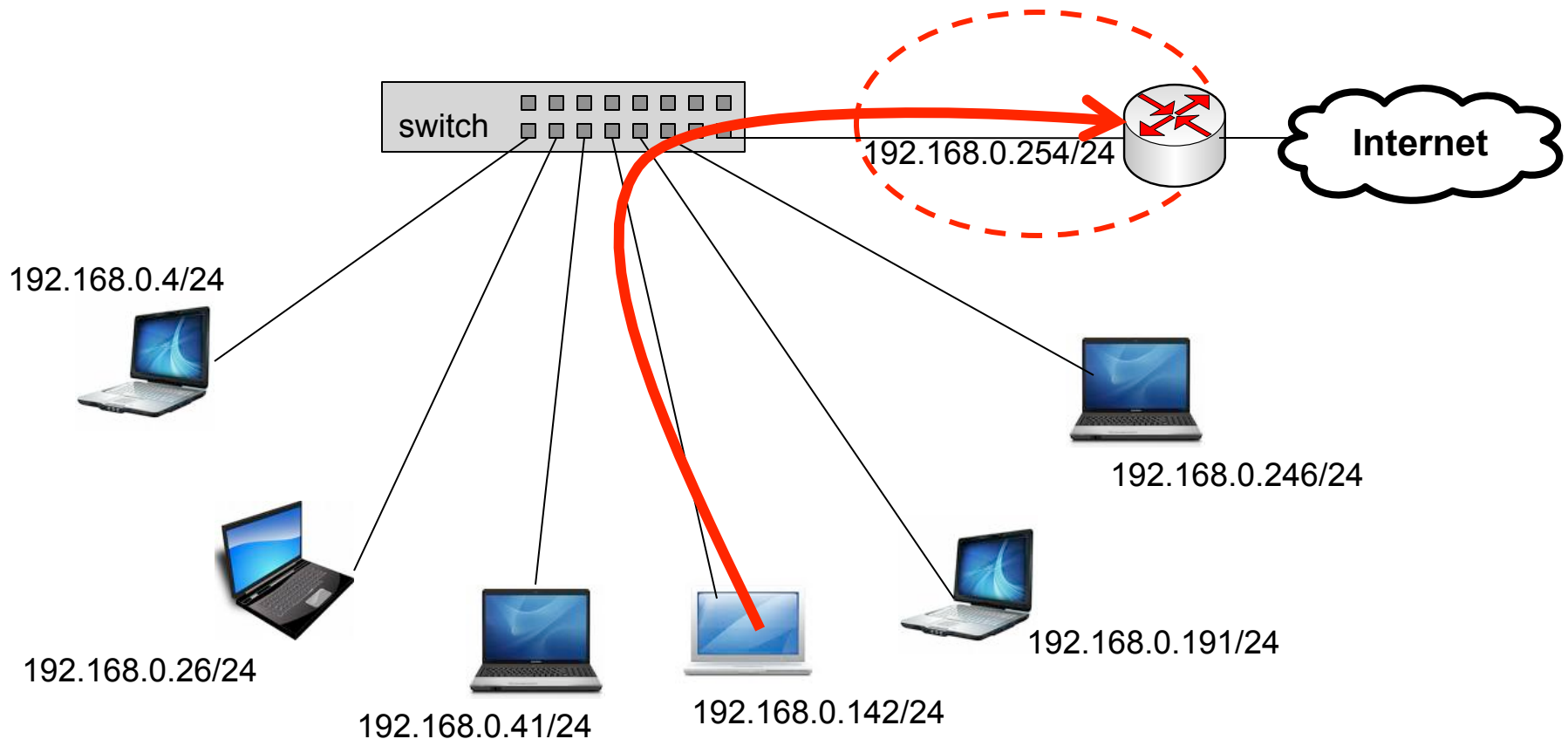

Konsep Dasar Jaringan

- DNS diperlukan untuk melakukan pengubahan nama domain menjadi ip address, karena seluruh proses pengaturan trafik dilakukan berdasarkan layer 3 OSI, yaitu ip address
- Contoh:
 - `www.yahoo.com` → `203.0.113.5`



Bridge, Switch & EoIP



Certified Mikrotik Training Basic Class

Organized by: Citraweb Nusa Infomedia

(Mikrotik Certified Training Partner)

● ● ● | Bridge - Concept

- Menggabungkan 2 atau lebih interface yang bertipe ethernet, atau sejenisnya, seolah-olah berada dalam 1 segmen network yang sama.
- Proses penggabungan ini terjadi pada layer data link.
- Mengaktifkan bridge pada 2 buah interface akan menonaktifkan fungsi routing di antara kedua interface tersebut.
- Mengemulasi mode **switch** secara software pada dua atau lebih interface.

System Bridge - Example

- o Memanfaatkan port-port pada Routerboard untuk menghubungkan Perangkat-perangkat jaringan **supaya berada dalam satu subnet / bridge network yang sama layaknya seperti Switch.**

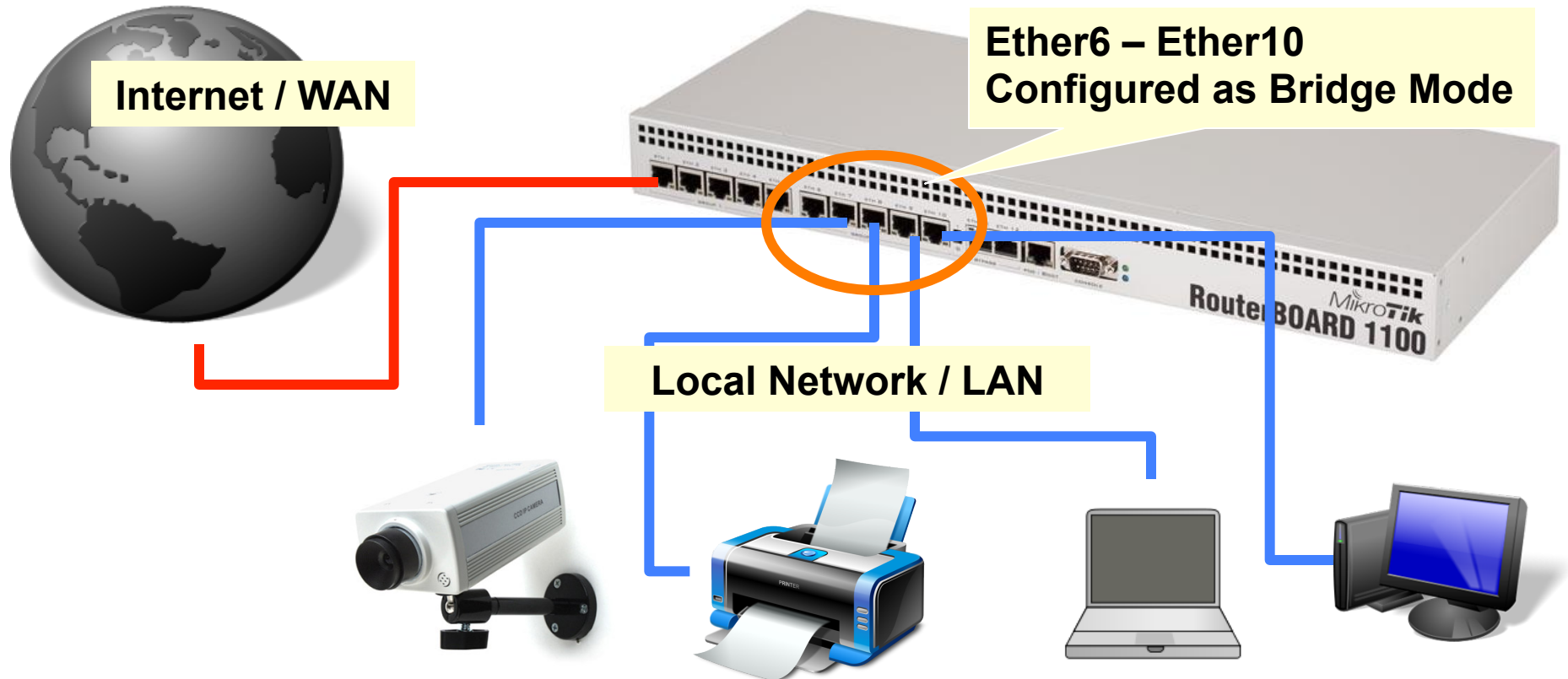

Bridge – Topology for Wireless

- Bayangkan kalau network wireless sudah terdiri dari beberapa BTS

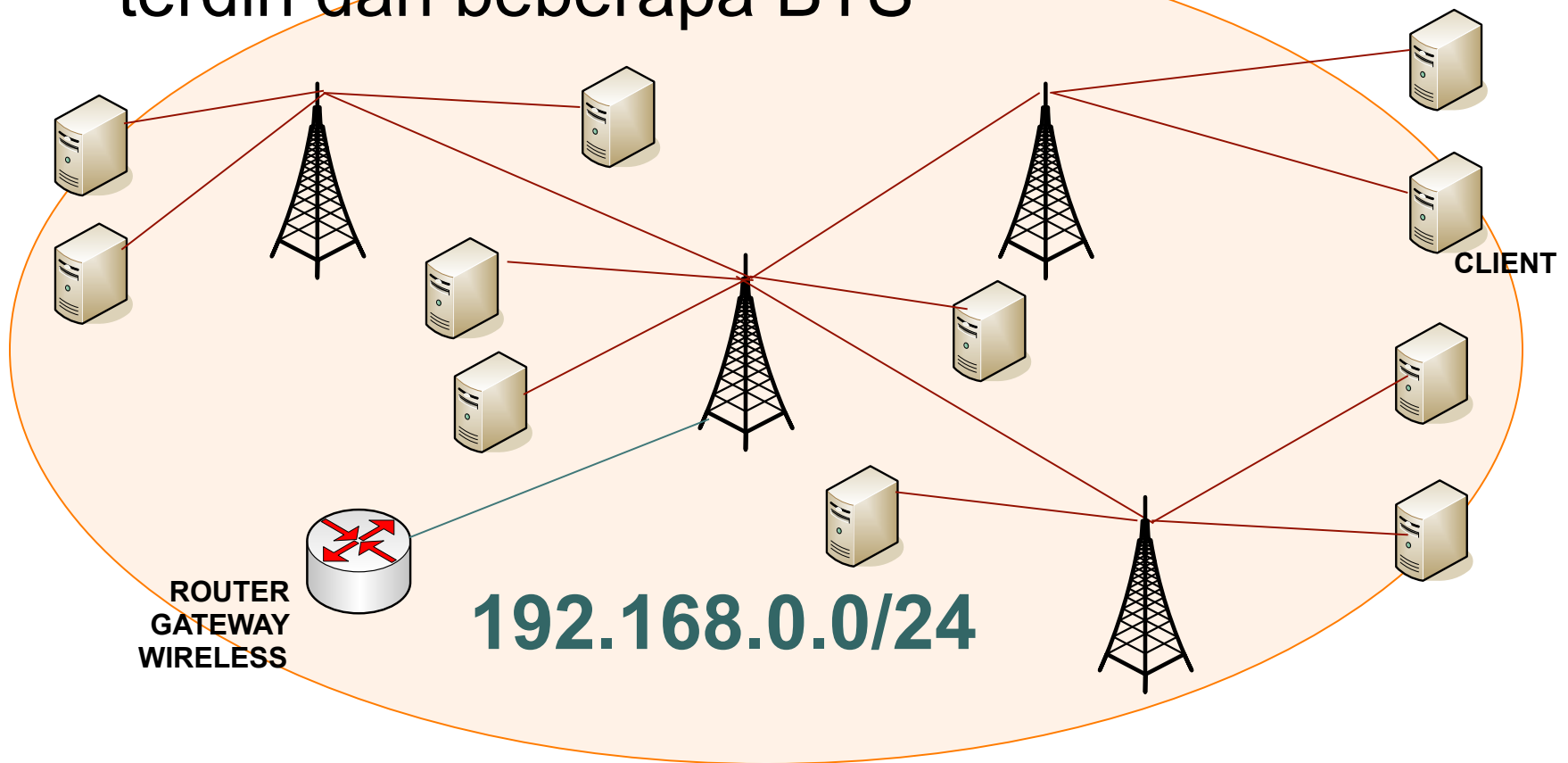



System Bridge

- Konsekuensi penggunaan Sistem Bridge
 - Sulit untuk mengatur trafik broadcast (misalnya akibat virus, dll)
 - Permasalahan pada satu segment akan membuat masalah di semua segment pada bridge yang sama
 - Sulit untuk membuat fail over system
 - Sulit untuk melihat kualitas link pada tiap segment
 - Beban trafik pada setiap perangkat yang dilalui akan berat, karena terjadi akumulasi traffic

Interface for Bridge Port

- Berikut ini jenis-jenis interface yang dapat dijadikan Bridge Port :
 - **Ethernet**
 - **VLAN**
 - Merupakan bagian dari ethernet atau wireless interface
 - Jangan melakukan bridge sebuah VLAN dengan interface induknya
 - **Wireless AP, WDS, dan Station-pseudobridge**
 - Note: station-pseudobridge tidak bisa di-bonding
 - **EoIP (Ethernet over IP)**
 - Lebih detail pada slide lain
 - **PPTP**
 - Selama bridge dilakukan baik di sisi server maupun client



Bridge!

- Kita tidak harus memasang IP Address pada sebuah bridge interface
- Jika kita menonaktifkan bridge, pada IP Address yang terpasang pada bridge akan menjadi invalid
- Kita tidak bisa membuat bridge dengan interface yang bukan bertipe ethernet seperti synchronous (serial), IPIP, PPPoE, dll.
- Namun, bisa kita lakukan bridge pada interface tersebut dengan membuat EoIP Tunnel terlebih dahulu.
- EoIP Tunnel dijelaskan lebih detail di bagian yang lain.

Bridge – Implementation Example

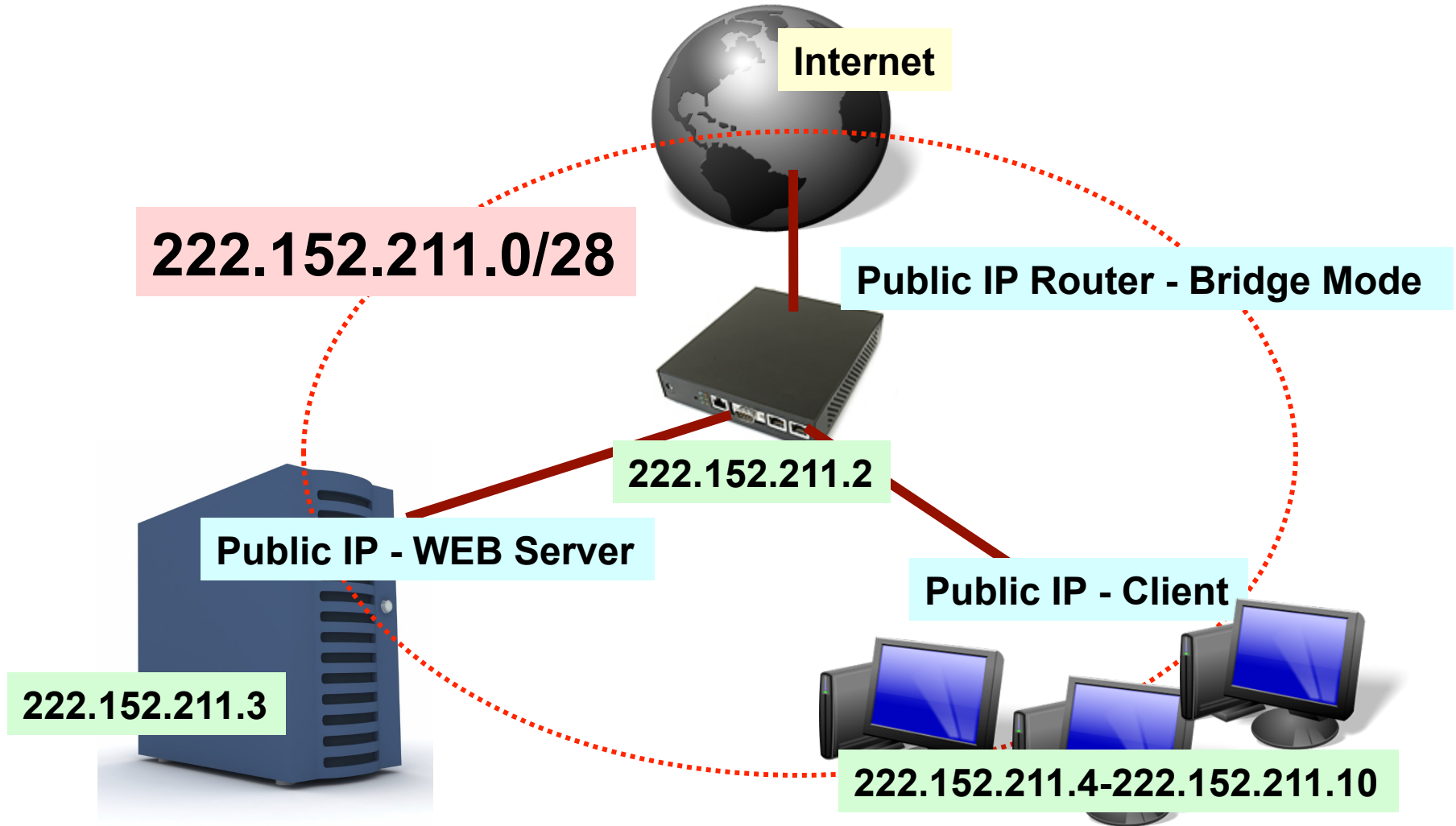

[LAB-1] Create Bridge

- o Membuat interface bridge

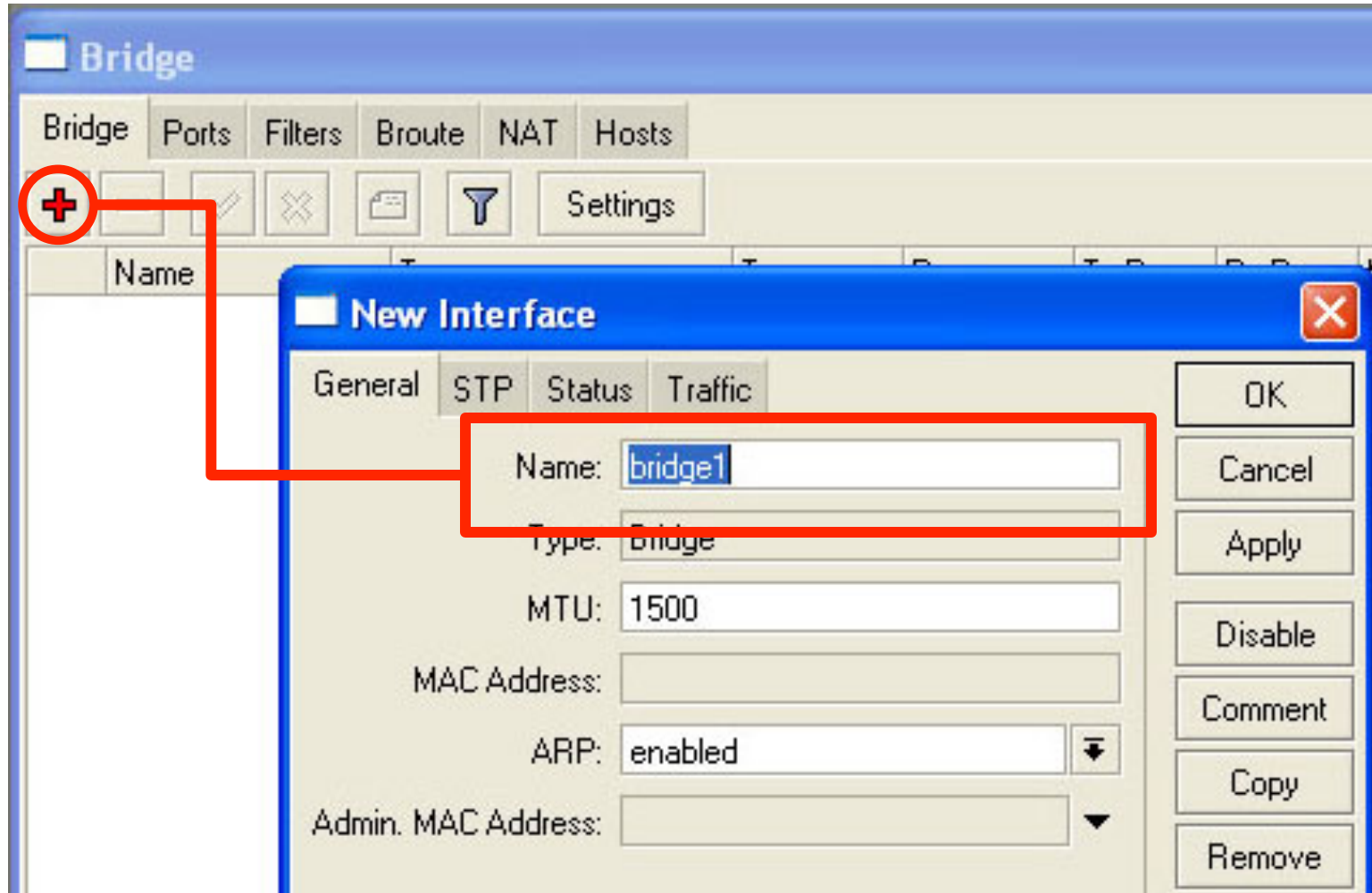

[LAB-2] Bridge Port

- Memasukkan interface ethernet ke interface bridge

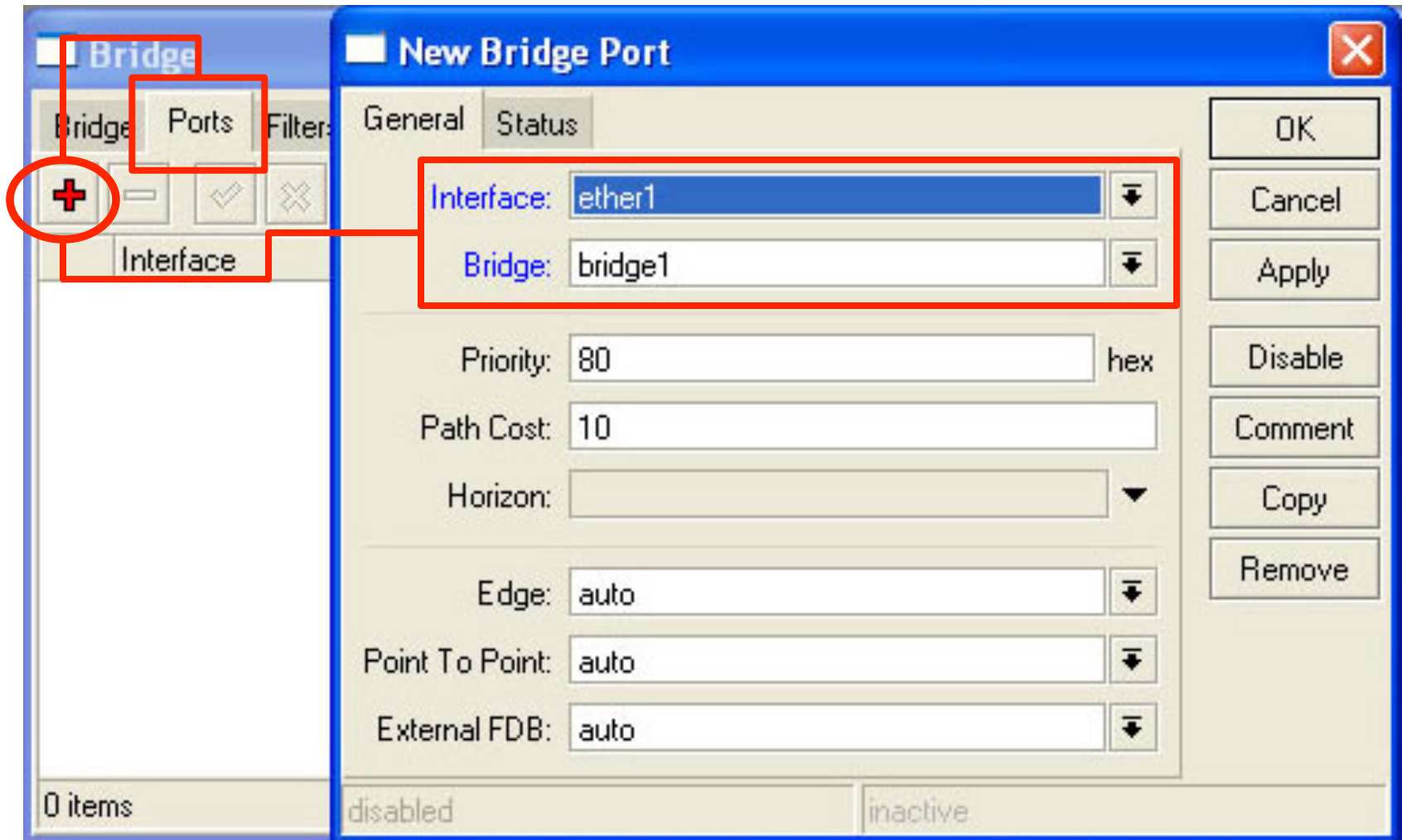

Bridge Monitoring

- o Untuk melihat mac-address host yang terkoneksi dengan bridge tersebut

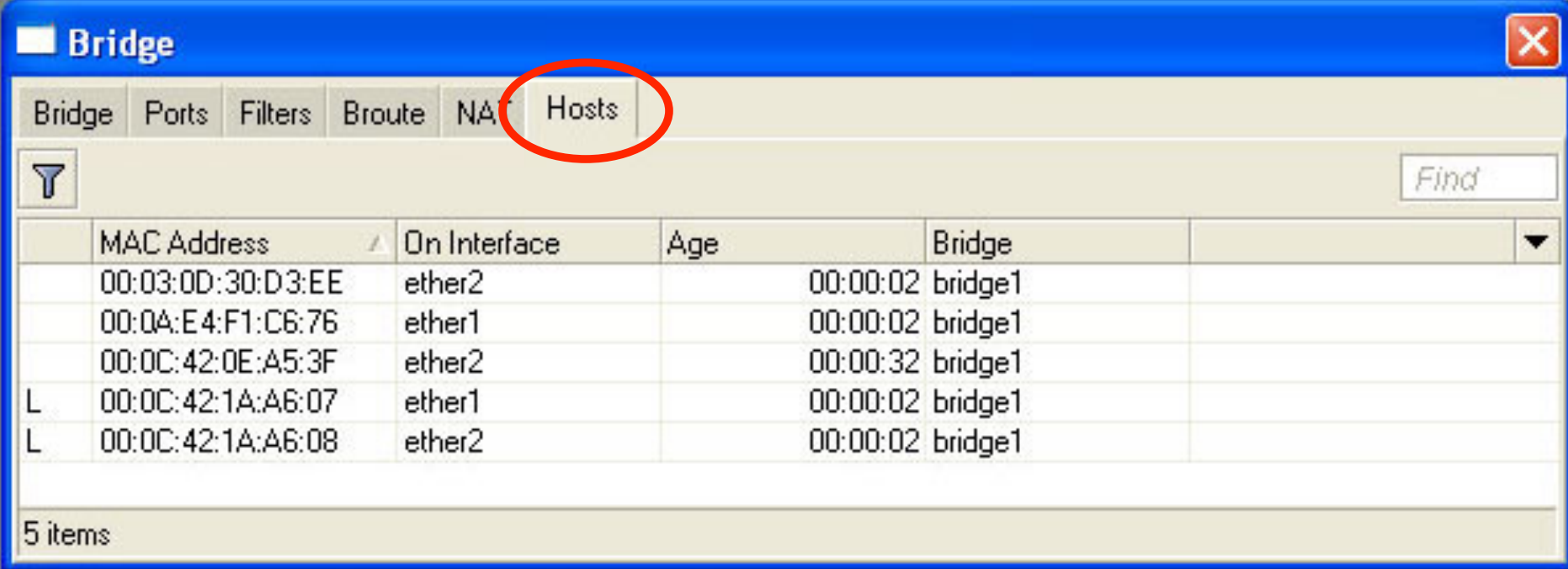

Bridge

Bridge Ports Filters Broute NAT **Hosts**

Find

	MAC Address	On Interface	Age	Bridge
	00:03:0D:30:D3:EE	ether2	00:00:02	bridge1
	00:0A:E4:F1:C6:76	ether1	00:00:02	bridge1
	00:0C:42:0E:A5:3F	ether2	00:00:32	bridge1
L	00:0C:42:1A:A6:07	ether1	00:00:02	bridge1
L	00:0C:42:1A:A6:08	ether2	00:00:02	bridge1

5 items

[LAB-3] Bridge Config

- Berpasangan dengan teman semeja, buatlah konfigurasi bridge berikut ini, sehingga dari laptop A bisa melakukan ping ke laptop B.

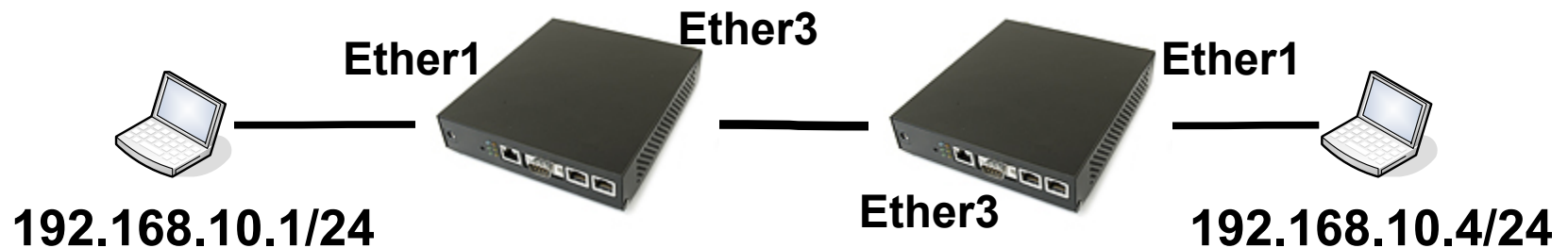

Switch Chipset

- Di beberapa hardware Routerboard, Chipset ethernet yang terpasang sudah memiliki fungsi Switch Chip.

The screenshot displays the Mikrotik WinBox interface. On the left, the 'Interface List' window shows a table of interfaces. On the right, the 'Interface <ether5>' configuration window is open, showing various settings for the selected interface.

Interface	Name	Type
R	ether1	Ethernet
	ether2	Ethernet
	ether3	Ethernet
S	ether4	Ethernet
S	ether5	Ethernet

The 'Interface <ether5>' configuration window shows the following settings:

- Name: ether5
- Type: Ethernet
- MTU: 1500
- L2 MTU: 1598
- Max L2 MTU: 4074
- MAC Address: D4:CA:6D:29:4C:2C
- ARP: enabled
- Master Port: ether2
- Bandwidth (Rx/Tx): unlimited / unlimited
- Switch: 0

Switch Chip – Cable SPEED !

- Dengan Switch Chip, memungkinkan transfer data antar port bisa mencapai cable speed tanpa membebani processor.

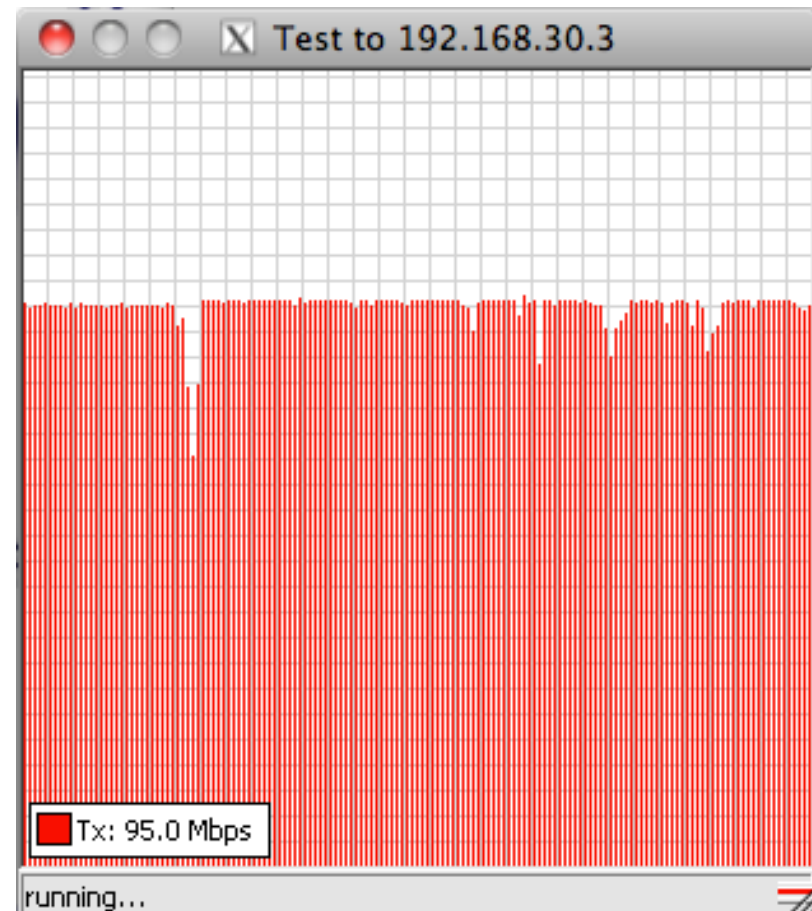

Ethernet over IP (EoIP)

- Adalah protocol pada Mikrotik RouterOS yang membangun sebuah **Network Tunnel** antar mikrotik router di atas sebuah koneksi TCP/IP.
- Interface EoIP dianggap sebagai sebuah Interface Ethernet
- Jika Bridge mode diberlakukan pada EoIP tunnel maka semua protocol yang berbasis ethernet akan dapat berjalan di Bridge tersebut (Dianggap seperti hardware interface ethernet yang di bridge).
- Hanya dapat dibuat di Mikrotik RouterOS
- Menggunakan Protocol **GRE** (RFC1701)

Network Skenario

- Bridge over WAN / Internet

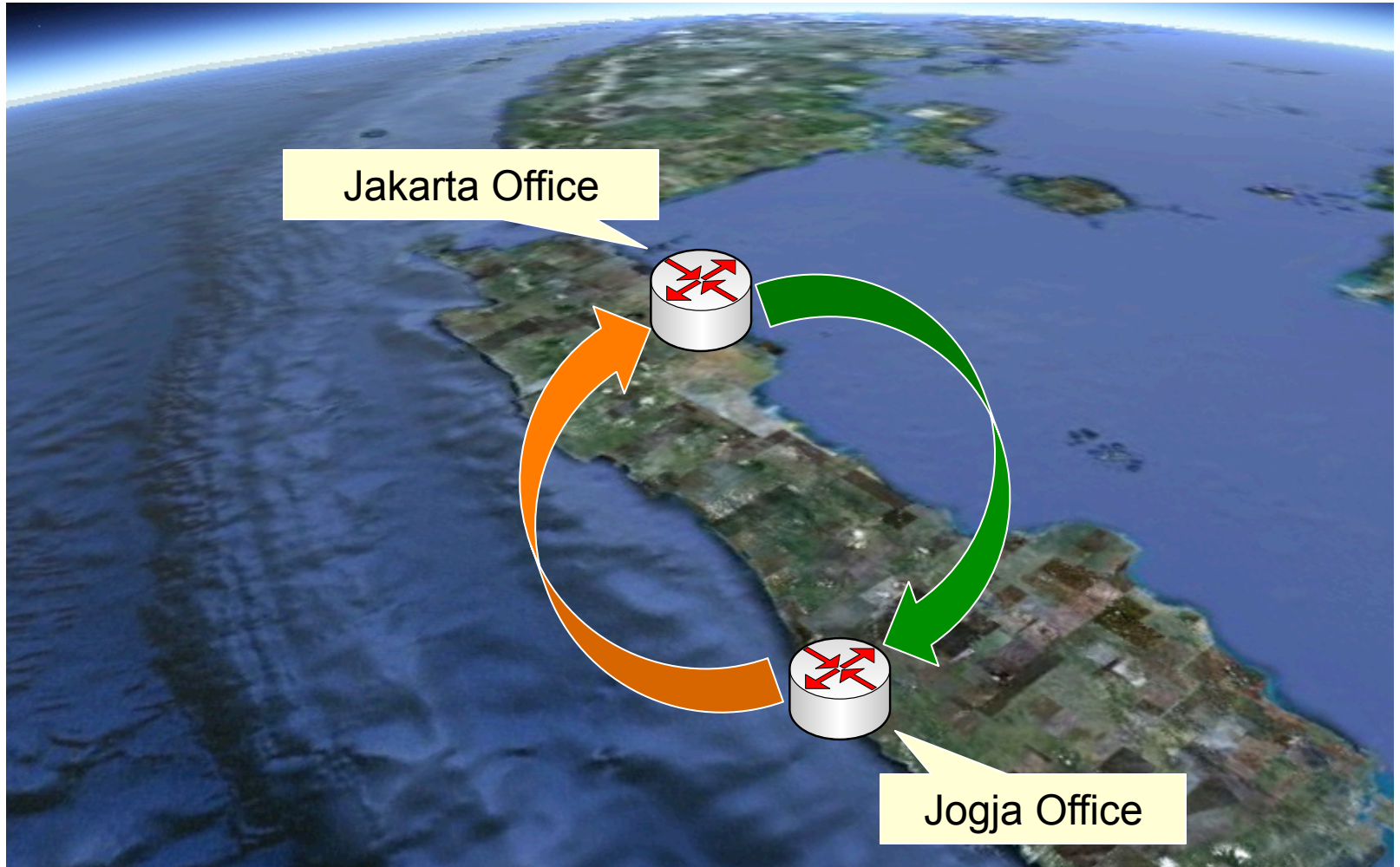

EoIP Example

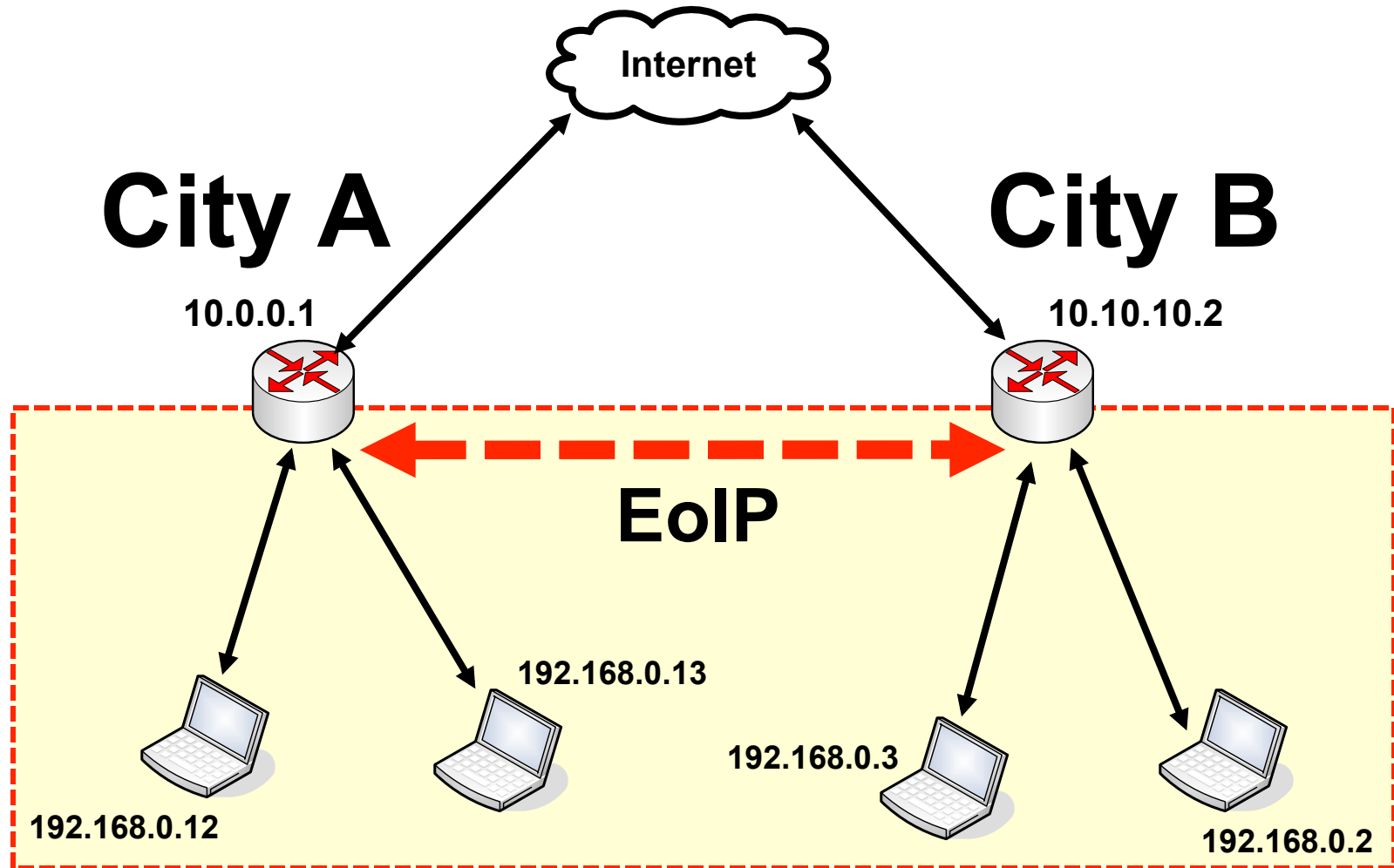

Secara Virtual setiap Laptop terletak di dalam satu segmen network yang sama.

EoIP Configuration - Example

The screenshot displays the Mikrotik WinBox interface for configuring an EoIP tunnel. The 'Interface List' window is open, showing a list of interfaces. The 'EoIP Tunnel' type is selected, and the configuration window for 'Interface <eoip-tunnel1>' is displayed. The configuration fields are as follows:

Field	Value
Name	eoip-tunnel1
Type	EoIP
MTU	1500
MAC Address	FE:00:90:31:CF:95
ARP	enabled
Remote Address	202.65.112.10
Tunnel ID	0

The 'EoIP Tunnel' option in the interface list and the 'Remote Address' and 'Tunnel ID' fields in the configuration window are highlighted with red boxes. The status bar at the bottom shows the interface is currently 'disabled'.

[LAB-6] EoIP Tunnels

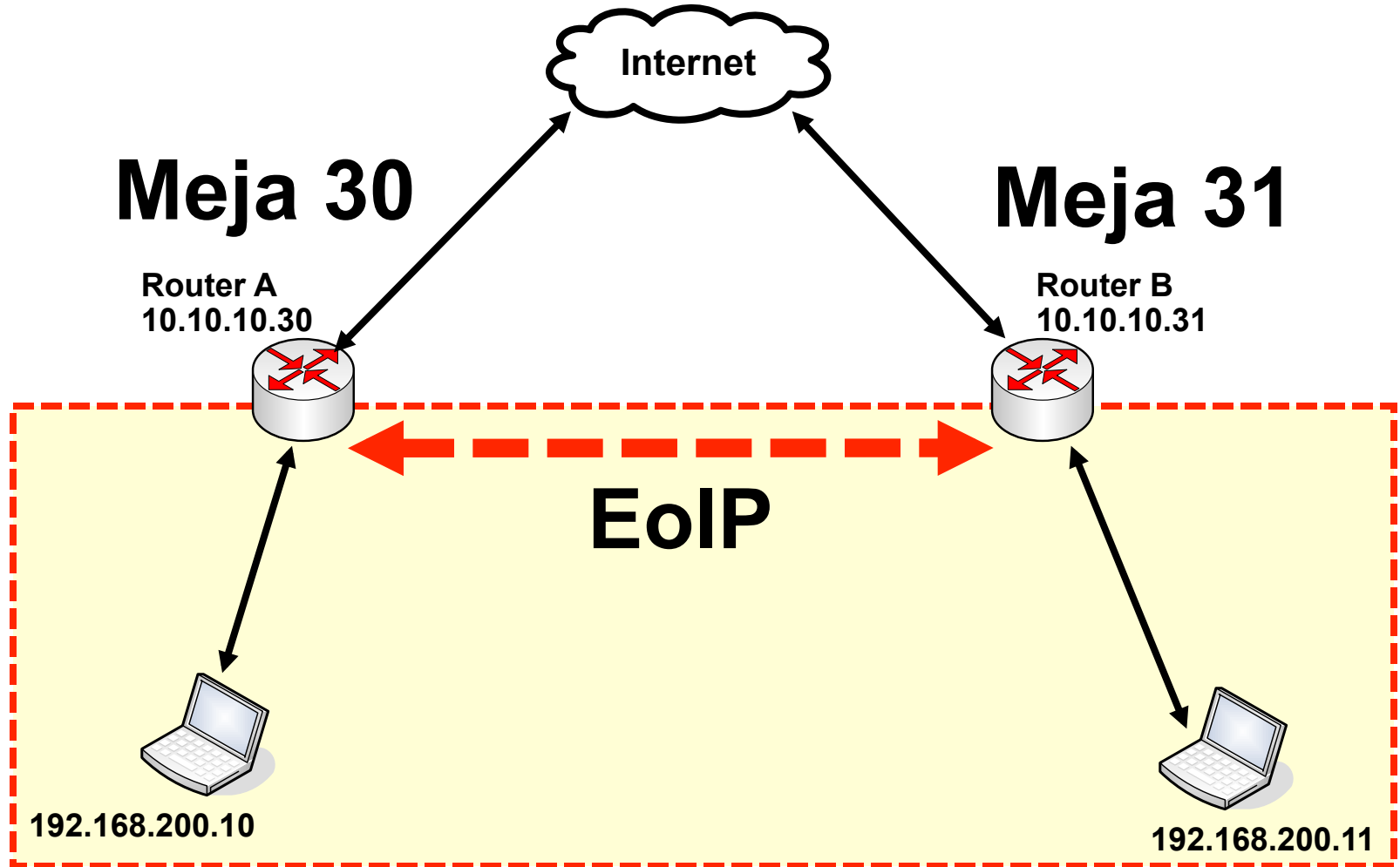

EoIP Tunnels - Config

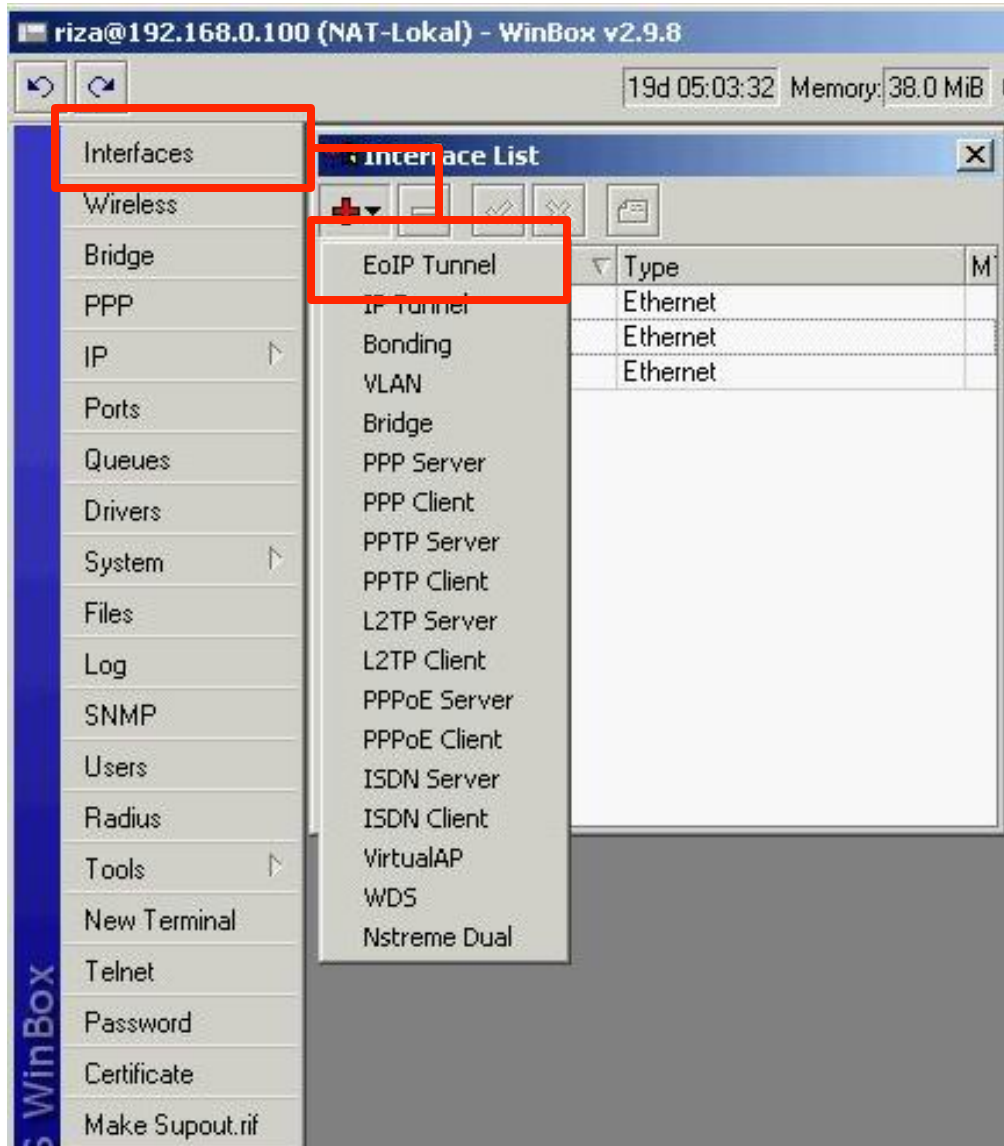

- Perlu diingat bahwa **TUNNEL ID** pada sebuah EoIP tunnel harus sama antar kedua EoIP Tunnel.
- **MAC Address** antar EoIP harus berbeda satu dengan yang lain.

EoIP Tunnels Config

ROUTER A

ROUTER B

New Interface

General Traffic

Name: eoip-tunnel1

Type: EoIP Tunnel

MTU: 1500

MAC Address: 02:FA:E2:81:F0:49

ARP: enabled

Remote Address: 10.10.10.30

Tunnel ID: 0

OK Cancel Apply Disable Comment Copy Remove Torch

disabled running slave

New Interface

General Traffic

Name: eoip-tunnel1

Type: EoIP Tunnel

MTU: 1500

MAC Address: 02:FA:E2:81:F0:50

ARP: enabled

Remote Address: 10.10.10.31

Tunnel ID: 0

OK Cancel Apply Disable Comment Copy Remove Torch

disabled running slave

Bridge Port Config – Add EoIP

The screenshot displays the Mikrotik WinBox interface for configuring a bridge. The main window is titled 'Bridge' and has tabs for 'Bridge', 'Ports', 'Filters', 'NAT', and 'Hosts'. A table lists the current bridge ports:

Interface	Bridge
eoip-tunnel1	bridge1
ether2	bridge1
ether1	bridge1

The 'New Bridge Port' dialog box is open, showing the configuration for a new port. The 'Interface' dropdown is set to 'eoip-tunnel1' and the 'Bridge' dropdown is set to 'bridge1'. Other settings include Priority: 80 (hex), Path Cost: 10, Horizon: (empty), Edge: auto, Point To Point: auto, and External FDB: auto.



Wireless Concept



Certified Mikrotik Training Basic Class

Organized by: Citraweb Nusa Infomedia

(Mikrotik Certified Training Partner)

Wireless LAN – 802.11

○ 802.11 – 2.4Ghz

- **802.11-b** : Wireless Lan yang menggunakan Frequency 2.4Ghz berkecepatan transfer data **11Mbps**
- **802.11-b/g** : Wireless Lan yang menggunakan Frequency 2.4Ghz berkecepatan transfer data **54Mbps**
- **802.11-b/g/n** : Wireless Lan yang menggunakan Frequency 2.4Ghz berkecepatan transfer data **300Mbps**

○ 802.11 – 5Ghz

- **802.11-a/g** : Wireless Lan yang menggunakan Frequency 5Ghz berkecepatan transfer data **54Mbps**
- **802.11-a/g/n** : Wireless Lan yang menggunakan Frequency 5Ghz berkecepatan transfer data **300Mbps**

Channels 80211-b

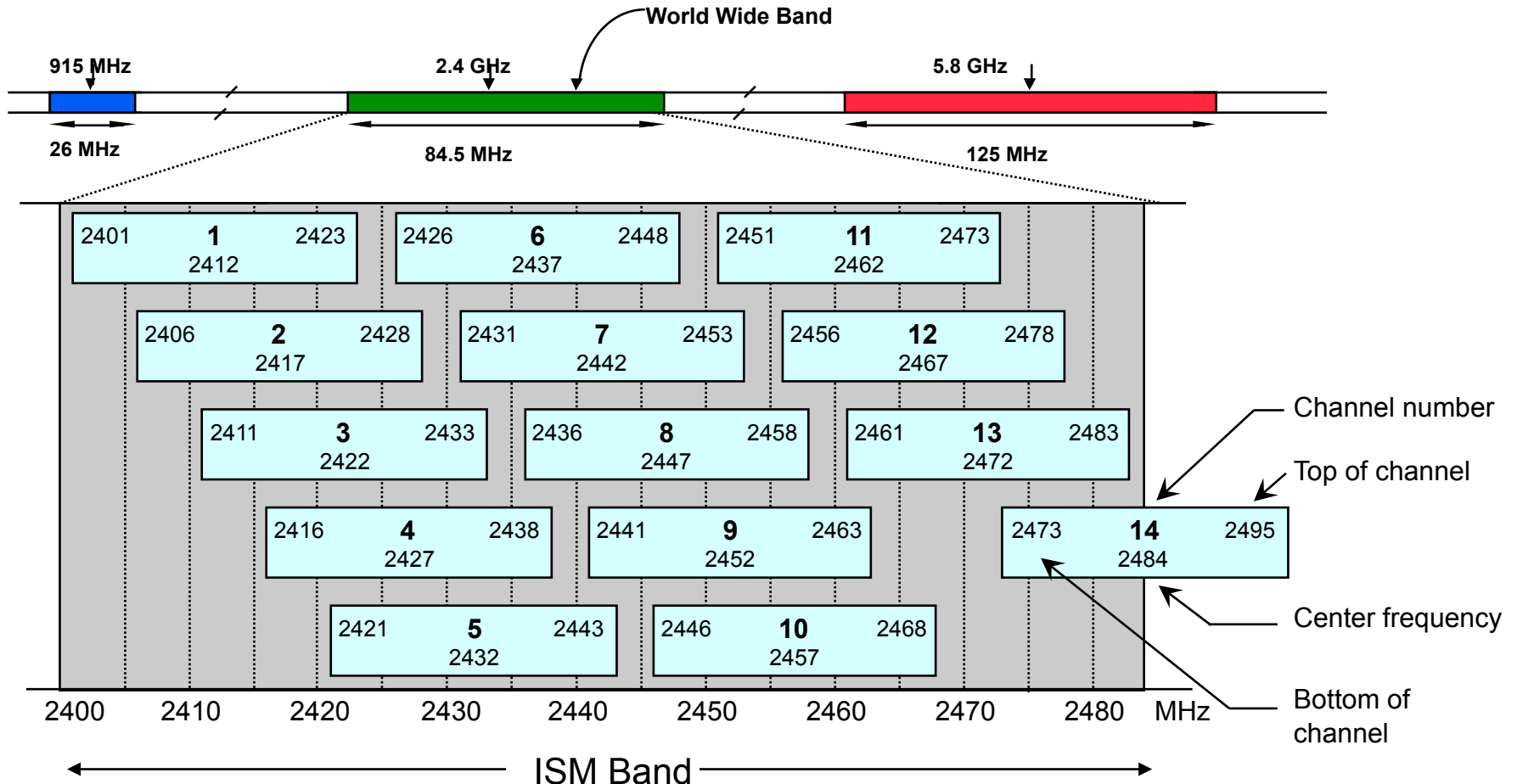

- (14) 20 MHz wide channels

Channels 80211-a

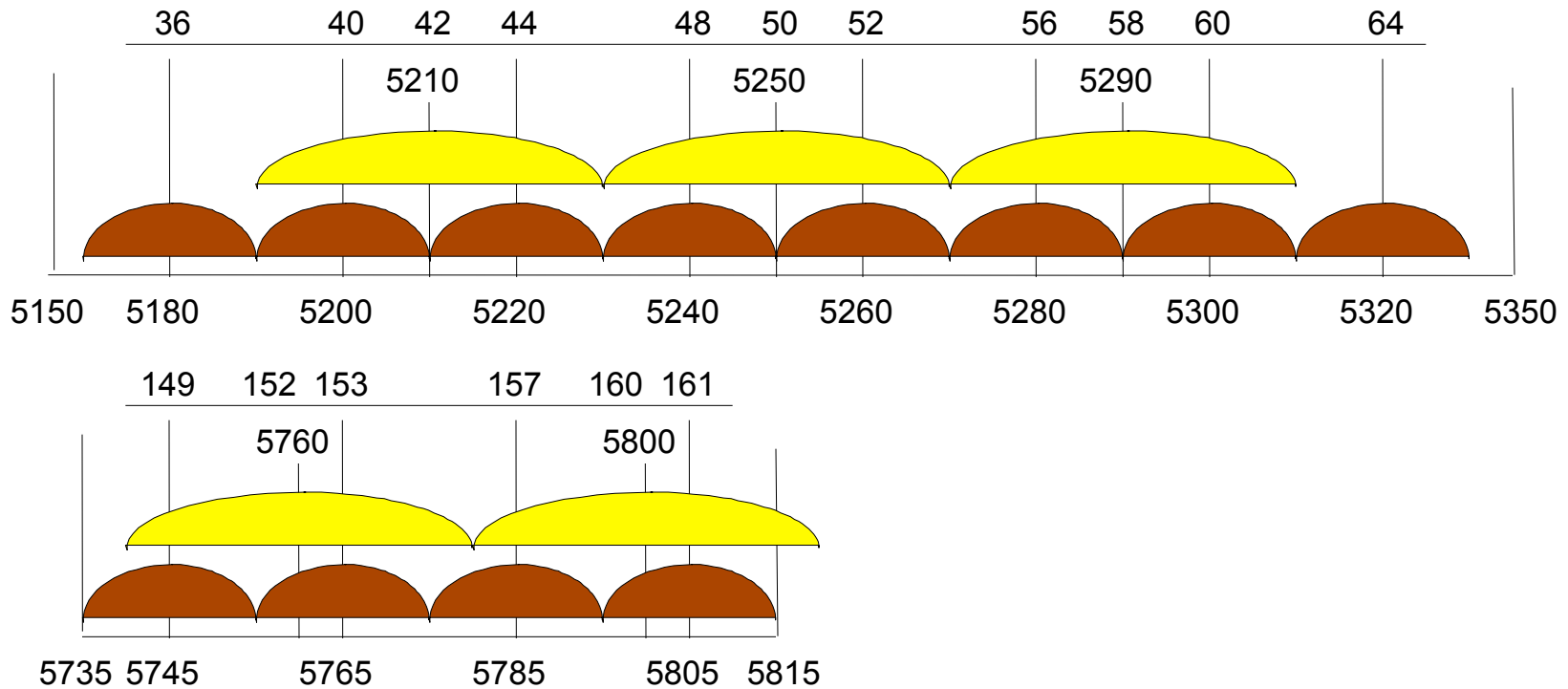

- (12) 20 MHz wide channels
- (5) 40MHz wide turbo channels

Kaidah dalam WirelessLAN

- Kaidah Wireless :
 - **Tx Power** – Daya Pancar signal wireless
 - **Rx Sensivity** – Sesitifitas Menerima signal
 - **Looses** – hambatan karena Kabel & Konektor
 - **EIRP** – Daya pancar total beserta Antenna
 - **Free Space Loss (FSL)** – Hambatan udara
- Kaidah Wireless Outdoor :
 - **Line of Sight** – Hambatan dan penghalang
 - **Freznel Zone** – Media rambat Frequency
 - **Lengkung Bumi** – Penghalang Wlan jarak jauh

Signal Calculation Formula

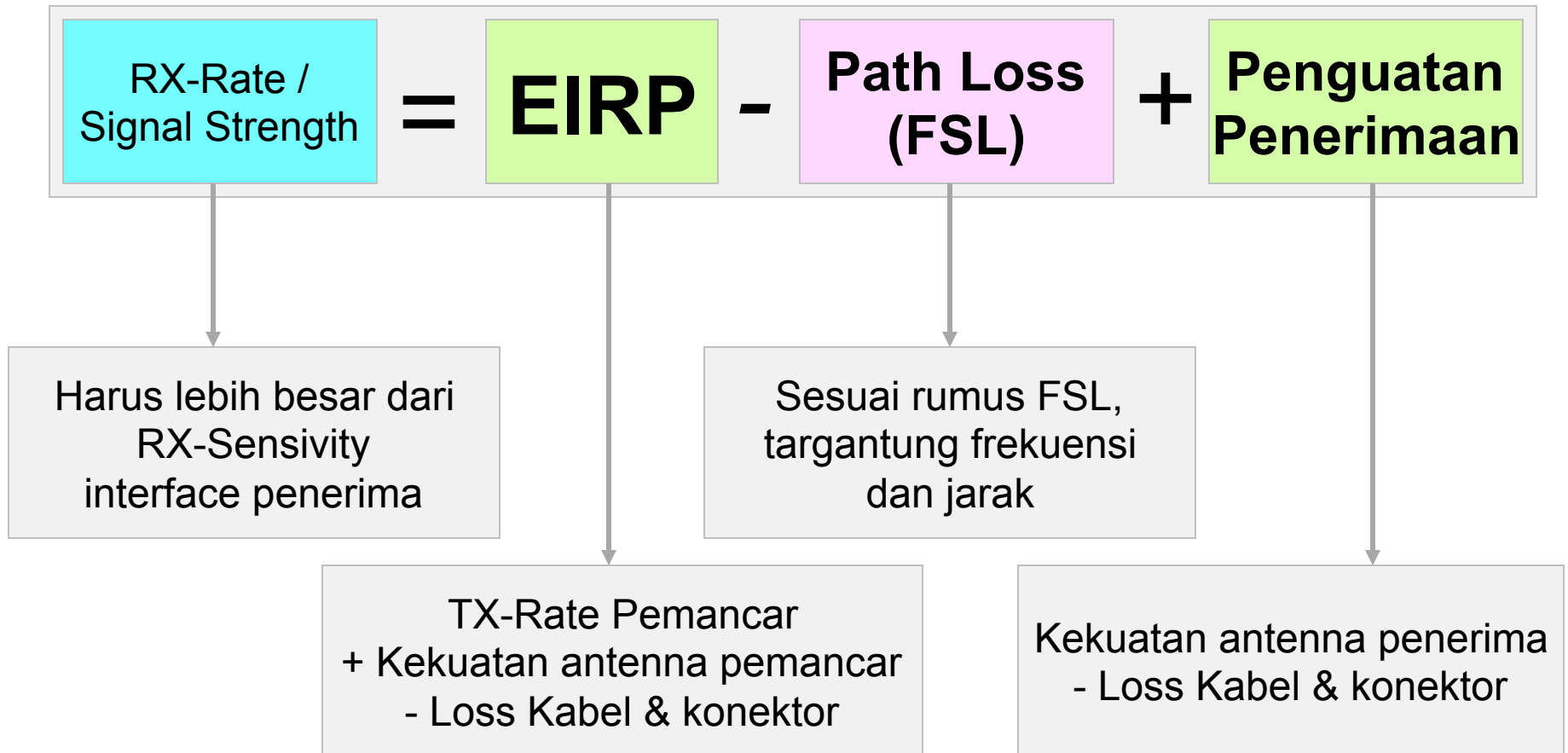



RX-Rate Calculation

- Contoh Kasus :
 - Access Point 100 mWatt
 - tanpa booster
 - kabel LMR400 100 feet
 - antenna grid 24 db
 - frekuensi 2,4 GHz
 - jarak 10 km

Calculation Example

<i>Perangkat</i>		<i>db</i>
Pemancar (EIRP)		
Access Point 100 mWatt	20 dbm	37.2 db (EIRP)
Kabel 30 meter	-6.8 db	
Antenna 24 db	24 dbi	
FSL / Path Loss 2,4 GHz 10 km		-120.026 db
Penerima (Penguatan Penerimaan)		
Kabel 30 meter	-6.8 db	17.2 db
Antenna 24 db	24 dbi	
RX-Rate / Signal Strength		-65.626 db

Online Calculator

Link Possibility Calculator

Parameters	SITE 1	SITE 2
Wireless cards		
Power	<input type="text" value="65"/> mW	<input type="text" value="65"/> mW
RX Sensitivity	<input type="text" value="-90"/> dBm	<input type="text" value="-90"/> dBm
Antennas		
Gain	<input type="text" value="24"/> dBi	<input type="text" value="24"/> dBi
Cables		
Length	<input type="text" value="3"/> m	<input type="text" value="3"/> m
Type:	<input type="text" value="LMR400"/>	<input type="text" value="LMR400"/>
Link		
Distance	<input type="text" value="10"/> km	
Frequency	<input type="text" value="2400"/> MHz	

Calculate

Link theoretical status	reliable
Theoretical signal level at site 1	-56/required -90
Theoretical signal level at site 2	-56/required -90

- [www.mikrotik.co.id/
test_link.php](http://www.mikrotik.co.id/test_link.php)

Line of Sight (LOS)

- Aplikasi Wireless LAN di luar ruangan harus memenuhi prinsip Line of Sight

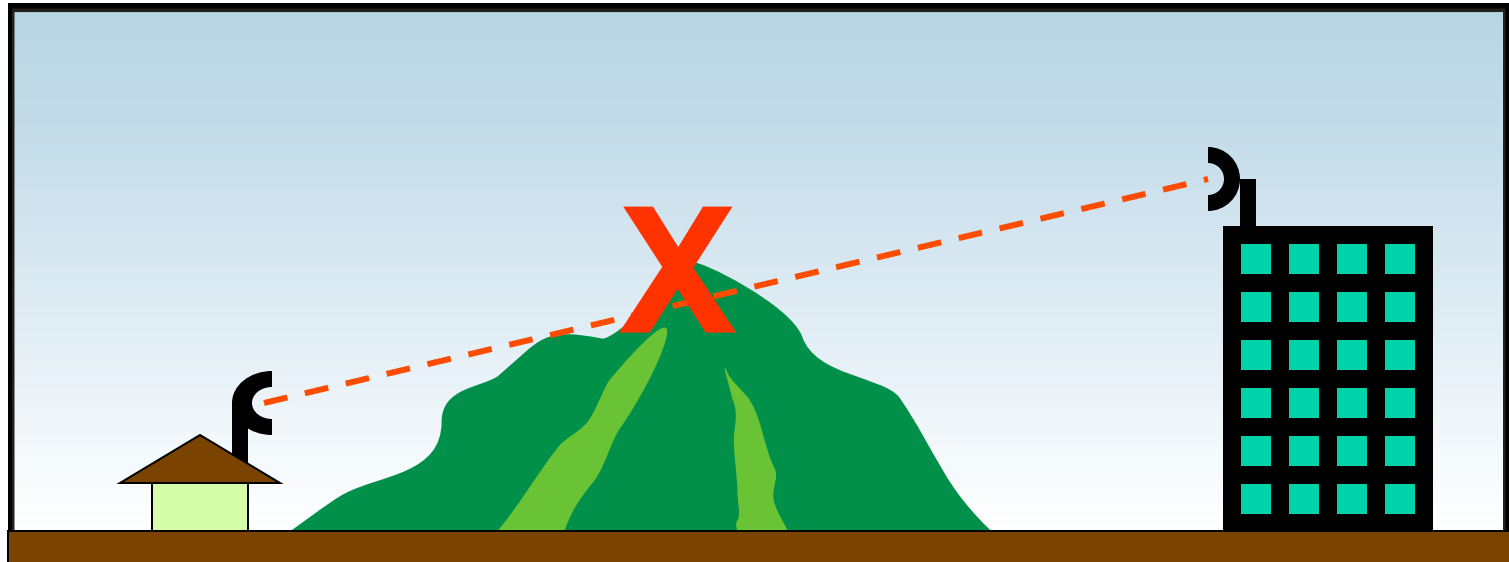

Line of Sight (LOS)

- Aplikasi Wireless LAN di luar ruangan harus memenuhi prinsip Line of Sight

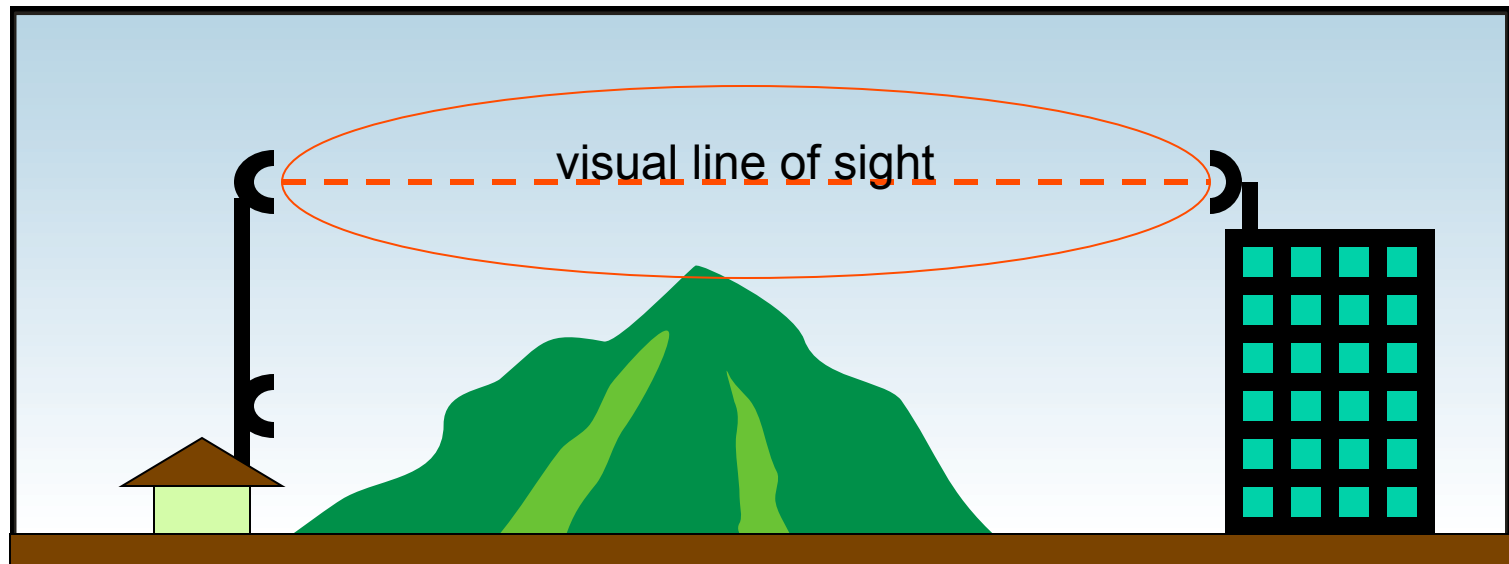

Ketinggian alat harus disesuaikan untuk mencapai line of sight

Earth Curve

- Untuk jarak yang cukup jauh, perencanaan ketinggian antena/tower harus memperhitungkan lengkung bumi.

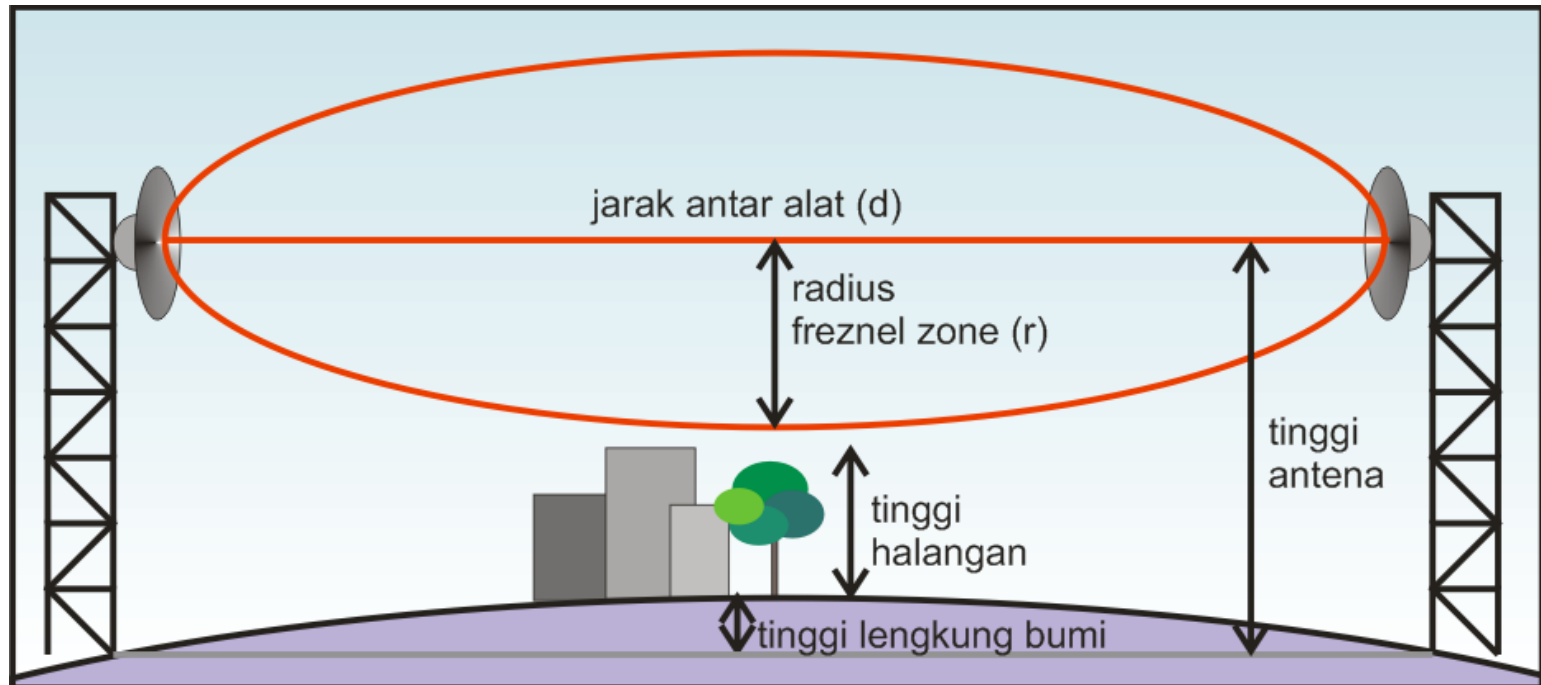

Antena Height Calculator

Masukkanlah Nilai Parameter berikut ini

Frekuensi : MHz
Jarak : km
Asumsi tinggi penghalang rata-rata : meter

Hasil Perhitungan

Jari-jari Fresnel Zone : 17.68 meter
80 % fresnel zone : 14.14 meter
Tinggi lengkung bumi : 1.96 meter
Tinggi antena minimum yang disarankan : 26.1 meter

- http://www.mikrotik.co.id/test_tower.php



Antenna Concept

- Directionality
 - Omnidirectional
 - Directional (limited range of coverage)
- Antenna Gain
 - In db
 - Higher db, longer distance coverage
- Polarization
 - Usually using vertical polarization

Omni Directional

Applications:

- 2.4 GHz ISM Band
- IEEE 802.11b, 802.11g Wireless LAN
- IEEE 802.11n (Pre-N, Draft-N, MIMO) Applications
- Bluetooth®
- WiFi
- Wireless Video Systems
- Multipoint and Mobile Applications

Features:

- Flexible "Rubber Duck" antenna
- Tilt and swivel design
- N-Male Connector
- RoHS Compliant

Electrical Specifications

- Frequency 2400-2500 MHz
- Gain 9 dBi
- Horizontal Beam Width 360°
- Vertical Beam Width 25°
- Impedance 50 Ohm
- Max. Power 50W
- VSWR < 2.0:1
- Lightning Protection DC Ground

Mechanical Specifications

- Length 15" (381 mm)
- Max. Diameter 0.62" (15.7 mm)
- Finish Matte Black
- Connector N-Male
- Operating Temperature -40° C to to 60° C (-40° F to 140° F)
- Polarization Vertical
- Flame Rating: UL 94HB
- RoHS Compliant: Yes

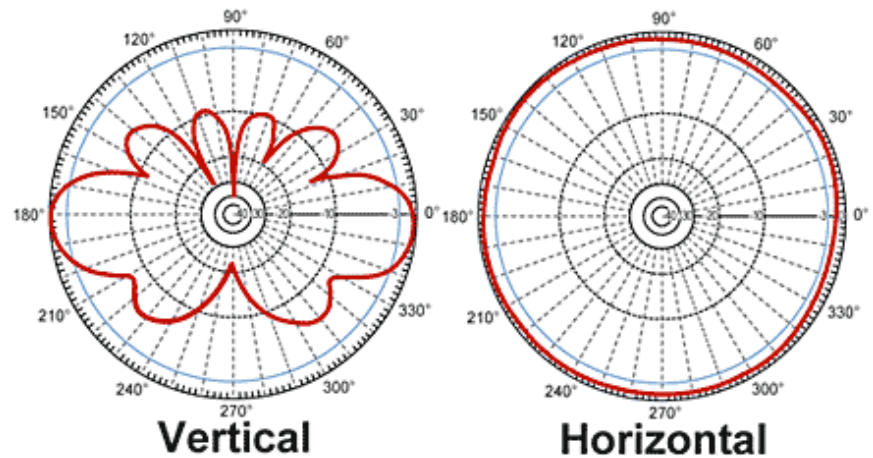
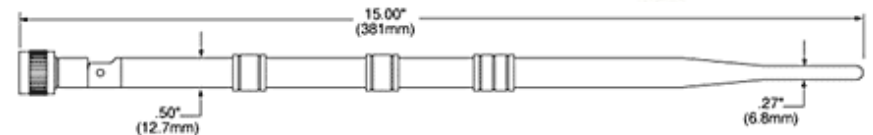

Flat Panel Antenna

Electrical

- **Frequency range:** 4.9 - 5.875 GHz
- **Gain, typ.:** 23 dBi @ 5.15-5.875 , 21 dBi @ 4.9-5.15
- **VSWR, max.:** 1.5 : 1 @ 5.15-5.875 , 1.9 : 1 @ 4.9-5.15
- **3 dB Beam-Width, H-Plane, typ.:** 10.5 °
- **3 dB Beam-Width, E-Plane, typ.:** 10.5 °
- **Side Lobes, min.:** -23 dB
- **Polarization:** Linear Vertical
- **Cross Polarization, min.:** -24 dB
- **Front to Back Ratio, min.:** -30 dB
- **Input power, max:** 30 Watt
- **Input Impedance:** 50 Ohm
- **Lightning Protection:** DC Grounded

Mechanical

- **Dimensions (HxWxD):** 305 x 305 x 15 mm (12"x12"x0.6")
- **Connector:** N-Type, Female
- **Back Plane:** Aluminum; protected through chemical passivation
- **Radome:** UV Protected Polycarbonate

Environmental

- **Operating Temperature Range:** -40° C to +65° C
- **Vibration:** According to IEC 60721-3-4
- **Wind Load:** 200 km/h (survival)
- **Flammability:** UL94
- **Water Proofing:** IP-67
- **Humidity:** ETS 300 019-1-4, EN 302 085 (annex. A.1.1)
- **Ice and Snow:** 25 mm radial (survival)
- **Salt Fog:** According to IEC 68-2-11
- **Service Life:** > 10 years

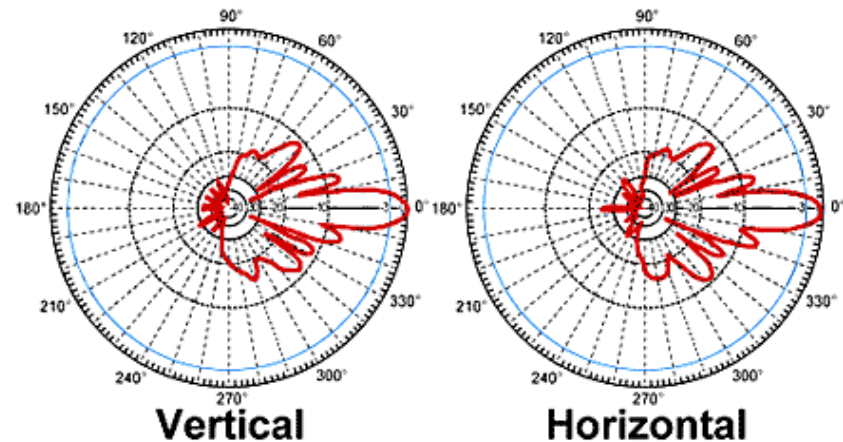

Grid Antenna



Model	HG5822G	HG5827G
Frequency	5725-5850 MHz	
Gain	22 dBi	27 dBi
Polarization	Horizontal or Vertical	
Horizontal Beam Width	10 °	6°
Vertical Beam Width	13 °	9°
Front to Back Ratio	25 dB	
Impedance	50 Ohm	
Max. Input Power	100 Watts	
VSWR	< 1.5:1 avg.	
Weight	3.0 lbs. (1.4 kg)	5.3 lbs. (2.4 kg)
Grid Dimensions	11.8 x 15.7 inches (300 x 400 mm)	15.7 x 23.6 inches (400 x 600 mm)
Mounting	2 in. (50.8 mm) diameter mast max.	
Operating Temperature	-40° C to to 85° C (-40° F to 185° F)	
Lighting Protection	DC Ground	
Connector	N-Female	

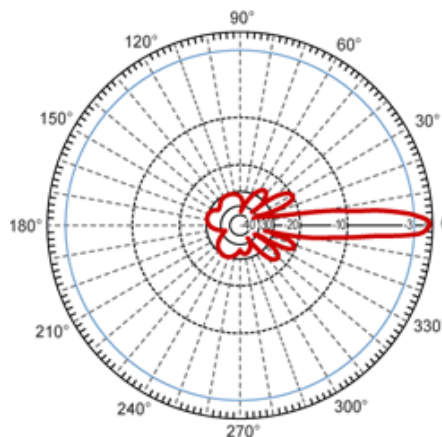

Horizontal

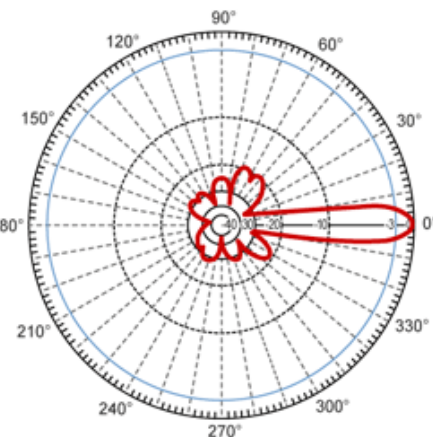

Vertical

Solid Disc Antenna



Spesifikasi Teknis

- **Frequency Band:** 5470 – 5725 MHz
- **Dimensions:** Diameter 500 mm
- **Gain:** 26,1 dBi
- **-3 dB Beamwidth:** 6°
- **Weight:** 1 500 g
- **Connector:** N – Female
- **Polarization:** Horizontal / Vertical
- **Impedance:** 50 ?
- **Material:** Aluminium + ABS

Biasanya digunakan untuk aplikasi point to point untuk jarak yang jauh.

Mounting pada tower harus baik, faktor angin cukup berpengaruh. Dibutuhkan ketelitian pointing.

Antenna Patterns

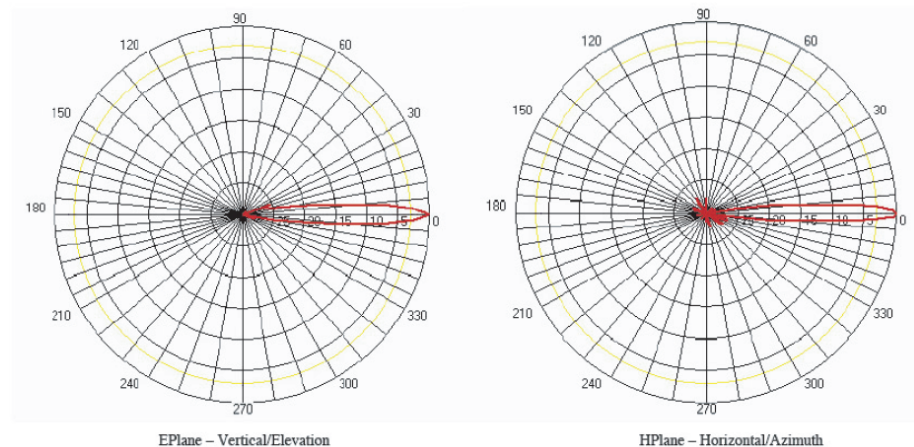

Sectoral Antenna



Frequency	2400-2500 MHz
Gain	20 dBi
Horizontal Beam Width	120 degrees
Vertical Beam Width	+/- 6.5°
Impedance	50 Ohm
Max. Input Power	250 Watts
VSWR	< 1.3:1 avg.
Connector	N Female
Lightning Protection	Direct Ground

Weight	12 lbs. (5.44 Kg)
Dimensions	39 x 9 x 2.5 inches (99 x 22.9 x 6.4 cm)
Radome Material	UV-Inhibited Polymer
Reflector Material	Aluminum
Operating Temperature	-40° C to to 85° C (-40° F to 185° F)
Mounting	2 inch (5 cm) O.D. pipe max.
Polarization	Vertical
Downtilt (mech)	0 to 20 degrees (adjustable)

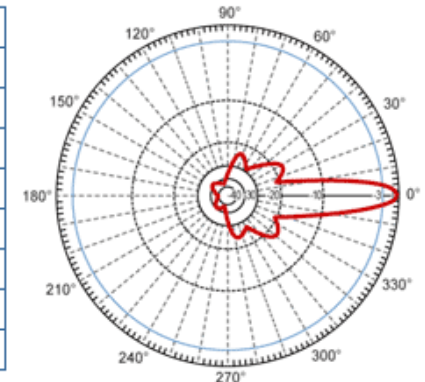

Vertical

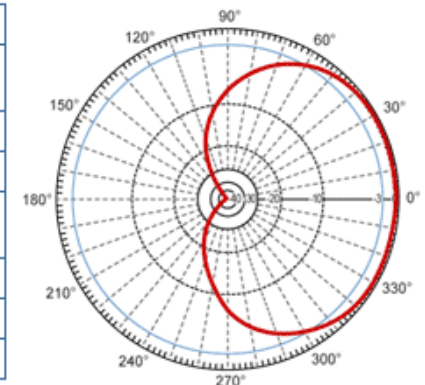

Horizontal

Sectoral Antenna (Array)



Models	HK2414-120	HK2417-120	HK2420-120
Frequency	2400 - 2500 MHz		
Antenna Gain	14 dBi*	17 dBi*	20 dBi*
Polarization	Vertical		
Horizontal Beam Width (Individual antenna)	120°	120°	120°
Vertical Beam Width (Individual antenna)	15°	6.5°	6.5°
Lightning Protection	DC Ground		
Power Rating (Single Fed)	25 Watts		
Antenna Radome Material	UV-inhibited Plastic		
Mounting System Material	Stainless Steel		
Mounting (Round Mast)	1¼" to 2" (31.7 to 50.8 mm) dia.		
Mounting (Square Mast/Beam)	3¼" (82.5 mm) square max.		
Dimensions **(O.D. Panels Fully Retracted)	20" (508 mm) x 17" (432 mm) O.D.**	39" (990 mm) x 17" (432 mm) O.D.**	39" (990 mm) x 17" (432 mm) O.D.**
Weight	14 lbs. (6.3 kg)	31 lbs. (14 kg)	44 lbs. (20 kg)

* Antenna gains specified when sectors are individually fed.

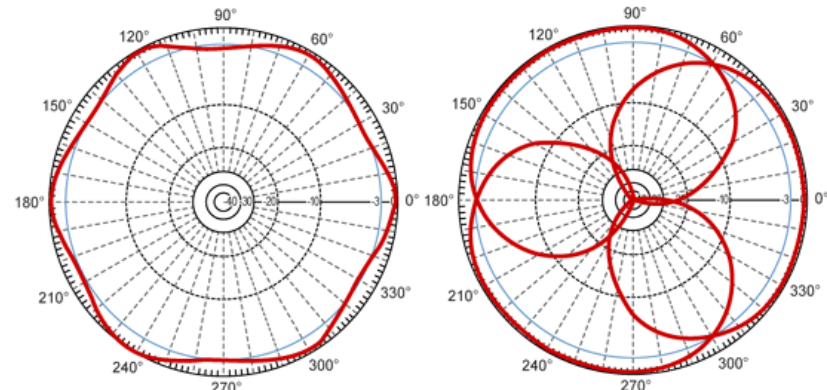

Single Fed Array

Individual Fed Array

Point to Point

- Menghubungkan 2 buah alat, biasanya menggunakan antenna directional dan jarak yang cukup jauh
- Kedua alat cukup menggunakan lisensi level 4 : Bridge dan Station
- Bisa menggunakan proprietary setting (nstream, Custom Frequency)



Point to Point (Dual Nstream)

- Masing-masing titik menggunakan 2 buah antenna dan 2 buah wireless card
- Satu link untuk transmit dan satu link untuk receive.
- Mikrotik proprietary setting

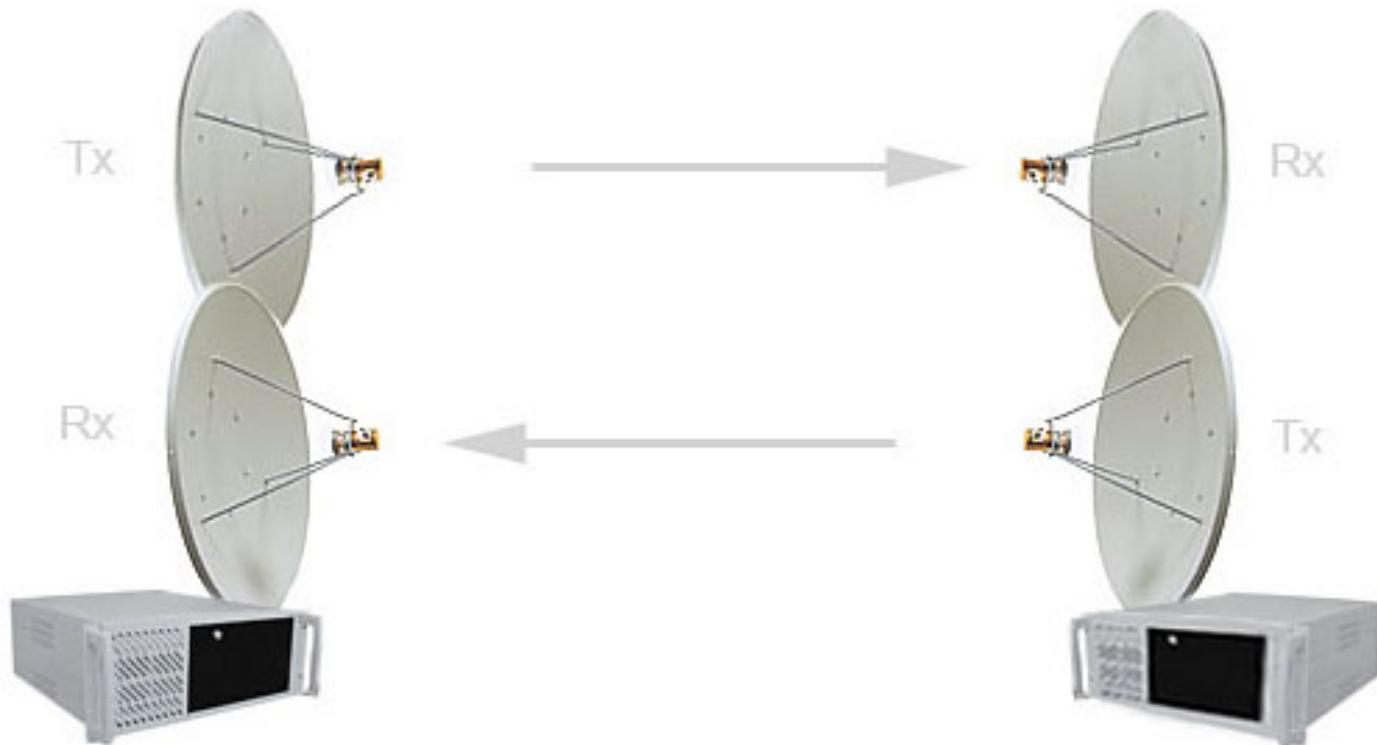

Point to Multipoint

- 1 buah AP Mikrotik sebagai base station untuk melayani CPE

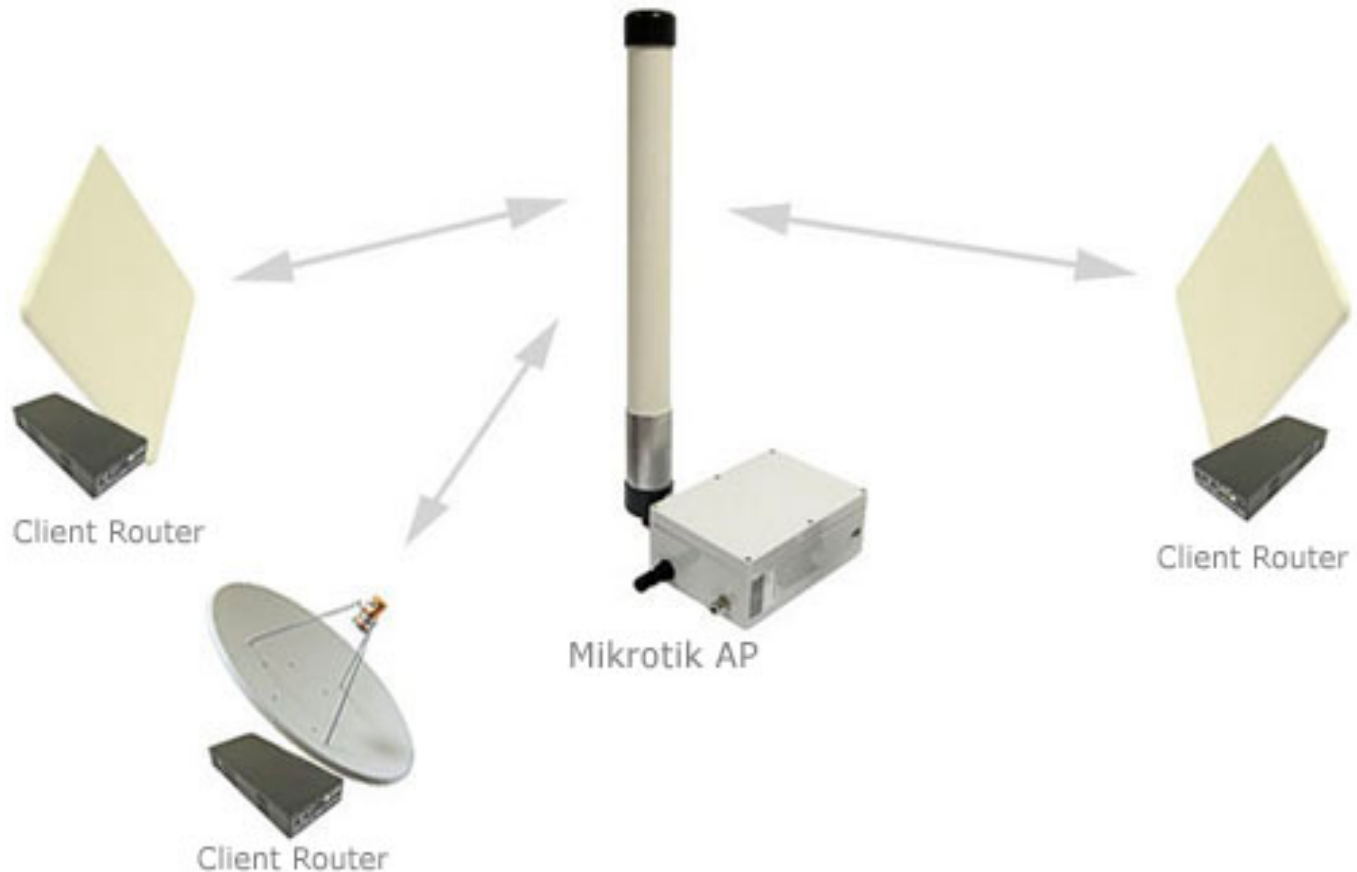

Wireless Distribution System (WDS)

- WDS (Wireless Distribution System) is the best way how to interconnect many access points and allow users to move around without getting disconnected from network.

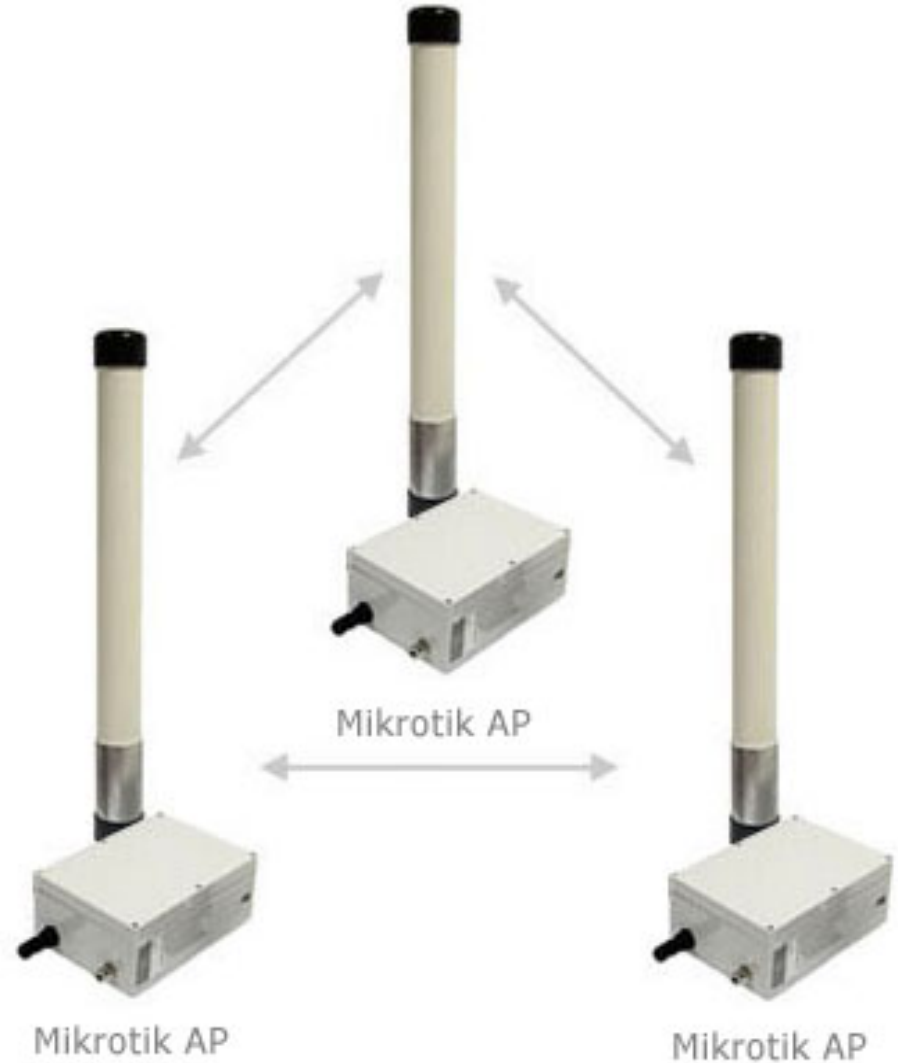



Wireless Configuration



Certified Mikrotik Training Basic Class

Organized by: Citraweb Nusa Infomedia

(Mikrotik Certified Training Partner)

Wireless Configuration

- Basic Configuration :
 - **Wireless Tools** – Scan, Snoop, Freq-Usage (site survey)
 - **Point to Point** – only “one” Client
 - **Registration Table** – Wireless Link Monitoring
 - **Wireless N (example)** – For “N Wireless Card”
 - **Wireless Bridge** – Inter-building Connection
 - **Point to Multi Point** – more than one Client
 - **Access List** – mac-address security
 - **Wireless Security – Encryption** wireless security
- Wireless Protocol
 - **VAP** – Virtual Access Point
 - **Nstreme** – Mikrotik Wireless Performance Protocol
 - **WDS** – Wireless Mesh Network

Scan Tool

Scanner (Running) □ ✕

Interface: ▾

Start

Stop

Close

New Window

Connect

Use Network

	Address	SSID	Band	Cha...	Freq...	Sign...	Nois...	Sign...	Radio Name	Router...	▾
BR	00:21:A4:35:00:37	Ndalem ...	2GHz-G	20Mhz	2412	-43	-100	57	0021A4350037	5.3	
BR	00:02:6F:56:4D:34		2GHz-G	20Mhz	2422	-92	-101	9	Maspion Rukun...	3.4	
BR	02:02:6F:56:4D:34	lambemu	2GHz-G	20Mhz	2422	-92	-101	9	Maspion Rukun...	3.4	
BR	02:02:6F:56:4D:35	kijing	2GHz-G	20Mhz	2422	-91	-101	10	Maspion Rukun...	3.4	
BR	00:15:6D:65:F7:E5	Giant4	2GHz-G	20Mhz	2447	-92	-103	11	00156D65F7E5	3.25	
BP	00:4F:62:28:4D:75	airlive	2GHz-G	20Mhz	2462	-92	-103	11			

Snoop Tool

Wireless Snoop

Interface: [v]

Start
Stop
Close
Settings
New Window

all [v]

	Frequen...	Band	Address	SSID	Signal	Of Freq. (%)	Of Traf. (%)	Bandwidth	Net...	Sta...	
	2419	2GHz-G				0.6		5.0 kbps	0	0	
	2422	2GHz-G				0.6		0 bps	2	2	
	2422	2GHz-G	00:02:6F:56:4D:34			0.0	0.0	0 bps		1	
N	...		00:02:6F:56:4D:34		-95	0.0	0.0	0 bps			
	2422	2GHz-G	02:02:6F:56:4D:34	lambemu		0.0	0.0	0 bps		1	
N	...		02:02:6F:56:4D:34	lambemu	-93	0.0	0.0	0 bps			
	2424	2GHz-G				0.0		0 bps	0	0	
	2427		00:19:7E:41:4B:F0		-72	0.0	0.0	0 bps			
	2427	2GHz-G				0.0		0 bps	0	1	
	2429	2GHz-G				0.0		0 bps	0	0	
	2432		00:15:6D:AD:9D:95		-90	0.4	36.0	16.9 kbps			
	2432	2GHz-G				1.3		21.9 kbps	1	2	
	2432	2GHz-G	00:0C:42:68:AF:B8	TheOne_...		0.5	45.8	4.9 kbps		1	
N	...		00:0C:42:68:AF:B8	TheOne_...	-95	0.5	45.8	4.9 kbps			
	2434	2GHz-G				0.0		0 bps	0	0	
	2437	2GHz-G				0.0		0 bps	0	0	

Wireless Menu

- Wireless Menu:
 - **Interface** – Daftar Interface wireless yang terpasang
 - **Access-List** – Security Mac-address Client (AP Mode)
 - **Registration** – Daftar Wireless yang terkoneksi
 - **Connect-List** – Security Mac-address AP (Station Mode)
 - **Security-Profile** – Konfigurasi Wireless Security (WPA/WEK)

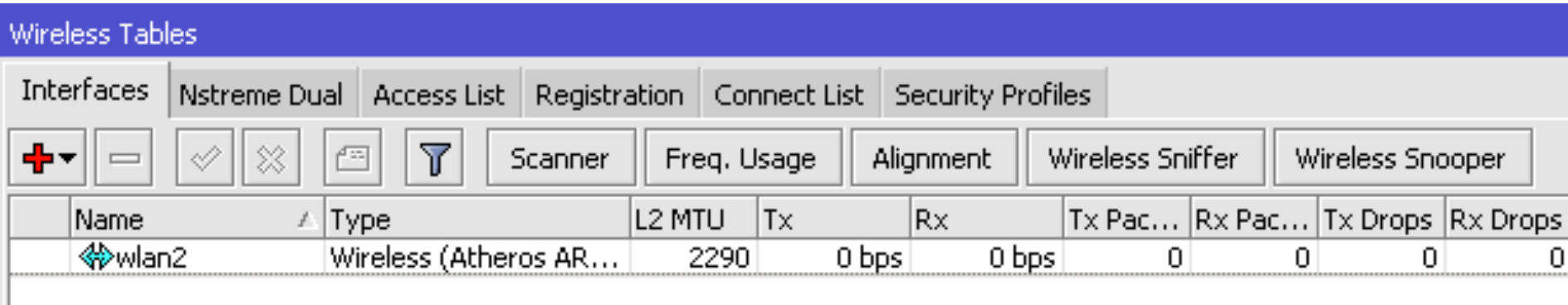

Wireless Tables

Interfaces | Nstreme Dual | Access List | Registration | Connect List | Security Profiles

+ - ✓ ✗ [Icon] [Icon] Scanner Freq. Usage Alignment Wireless Sniffer Wireless Snooper

Name	Type	L2 MTU	Tx	Rx	Tx Pac...	Rx Pac...	Tx Drops	Rx Drops
wlan2	Wireless (Atheros AR...	2290	0 bps	0 bps	0	0	0	0

Wireless Mode List

Wireless Mode :

- alignment-only
- ap-bridge
- bridge
- nstreme-dual-slave
- station
- station-wds
- wds-slave
- station-pseudobridge
- station-pseudobridge-clone

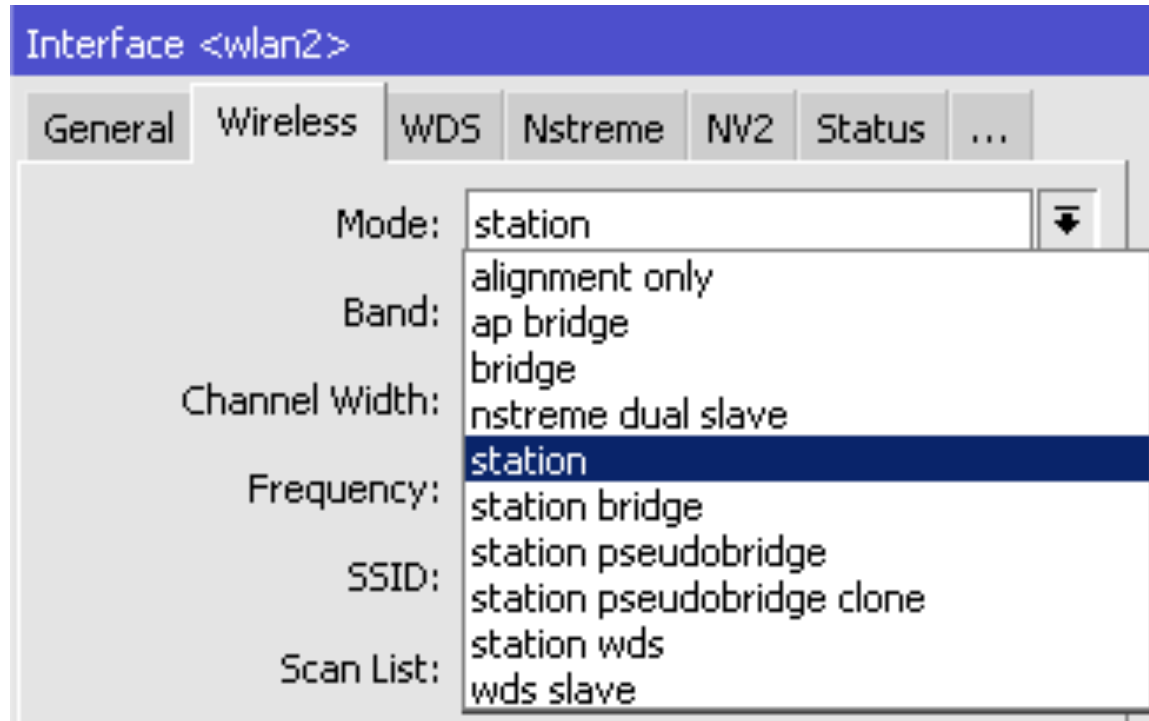

Wireless Mode - 1

- **alignment-only** – Digunakan untuk melakukan pointing dengan bantuan “**Beeper**” pada Routerboard.
- **ap-bridge** – Mode wireless sebagai Access Point untuk topologi **Point-to-Multipoint**.
- **bridge** – Mode wireless sebagai Access Point untuk topologi **Point-to-Point** (hanya bisa menerima satu client).
- **nstreme-dual-slave** – Mode wireless untuk mengaktifkan topologi Nstreme-dual (Wireless Full Duplex)
- **station** – Mode Wireless sebagai Client untuk topologi **Point-to-Point** dan juga **Point-to-Multipoint**

Wireless Mode – 2

- **station-wds** – Mode wireless sebagai client tetapi mengaktifkan protocol WDS (Digunakan untuk wireless WDS client)
- **wds-slave** – Mode wireless sebagai Access Point dan juga mengaktifkan protocol WDS (Digunakan untuk wireless WDS repeater)
- **station-pseudobridge** – Mode wireless sebagai client yang bisa mengaktifkan bridge pada “**station**” tanpa harus menggunakan protocol WDS
- **station-pseudobridge-clone** – Mode wireless sama seperti **station-pseudobridge** yang dilengkapi dengan fungsi cloning mac-address dari interface ethernet

[LAB-1] Point to Point

○ AP Side

- Min Licence Level 3
- Set mode, ssid, band, frequency
- mode=bridge
 - Can serve only 1 station

○ Client Side

- Min Licence Level 3
- Set mode, ssid, band, scan-list
- mode=station
- Make sure frequency is in scan-list



[LAB-1] P2P (AP Side)

- Konfigurasi :
- Set **mode**, **ssid**, **band** dan **frequency**
- mode=bridge
 - Hanya bisa terkoneksi dengan 1 station (1 client)

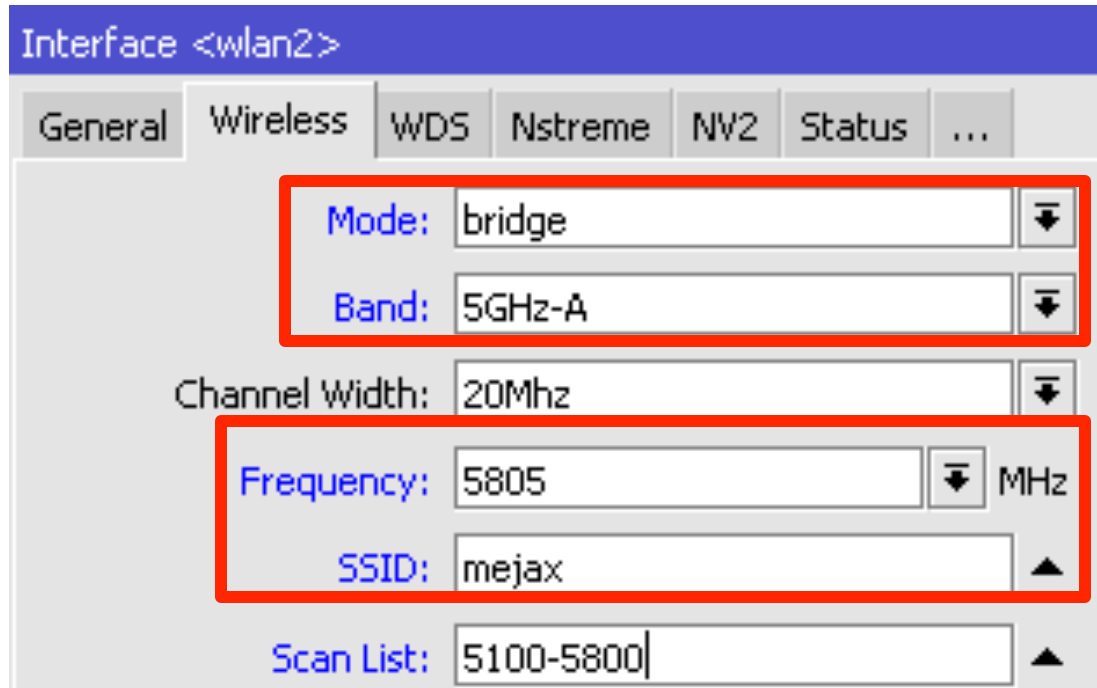

Interface <wlan2>

General Wireless WDS Nstreme NV2 Status ...

Mode: bridge

Band: 5GHz-A

Channel Width: 20Mhz

Frequency: 5805 MHz

SSID: mejax

Scan List: 5100-5800

[LAB-1] P2P (Client Side)

- Konfigurasi :
- Set **mode**, **ssid**, **band** dan **scan-list**
- mode=station
- Pastikan frequency yang dipilih oleh AP masuk dalam range scan-list

The screenshot shows the configuration page for the wlan2 interface in Mikrotik WinBox. The 'Wireless' tab is selected. The following settings are visible and highlighted with red boxes:

- Mode:** station
- Band:** 5GHz-A
- Channel Width:** 20Mhz
- Frequency:** 5805 MHz
- SSID:** mejax
- Scan List:** 5100-5800

Monitoring Wireless Interface

Wireless Tables

Interfaces | Nstreme Dual | Access List | **Registration** | Connect

[-] [Filter] [Reset]

Radio Name	MAC Address	Interface	Uptime
0021A43...	00:21:A4:35:00:37	wlan2	00:1

AP Client <00:21:A4:35:00:37>

General | 802.1x | Signal | Nstreme | NV2 | Statistics

Radio Name: 0021A4350037

MAC Address: 00:21:A4:35:00:37

Interface: wlan2

Uptime: 00:12:12

Distance: 1 km

RouterOS Version: 5.3

AP Client <00:21:A4:35:00:37>

General | 802.1x | **Signal** | Nstreme | NV2 | Statistics

Last Activity: 1.000 s

Tx/Rx Signal Strength: -28/-43 dBm

Tx/Rx Signal Strength Ch0: -43 dBm

Tx/Rx Signal Strength Ch1:

Tx/Rx Signal Strength Ch2:

Signal To Noise: 57 dB

Tx/Rx CCQ: 13/11 %

P Throughput: 7823 kbps

- Signal Strengths -

Rate	Strength	
1Mbps	-43	<div style="width: 43%;"></div>
11Mbps	-41	<div style="width: 41%;"></div>
2Mbps	-40	<div style="width: 40%;"></div>
9Mbps	-39	<div style="width: 39%;"></div>
5.5M...	-38	<div style="width: 38%;"></div>

[LAB-2] Point to Point Test

- Tambahkan IP address di interface **Wlan2**.
- Test koneksi wireless kedua router dengan tool Ping.
- Setelah test ping berhasil maka wireless point-to-point sudah siap.

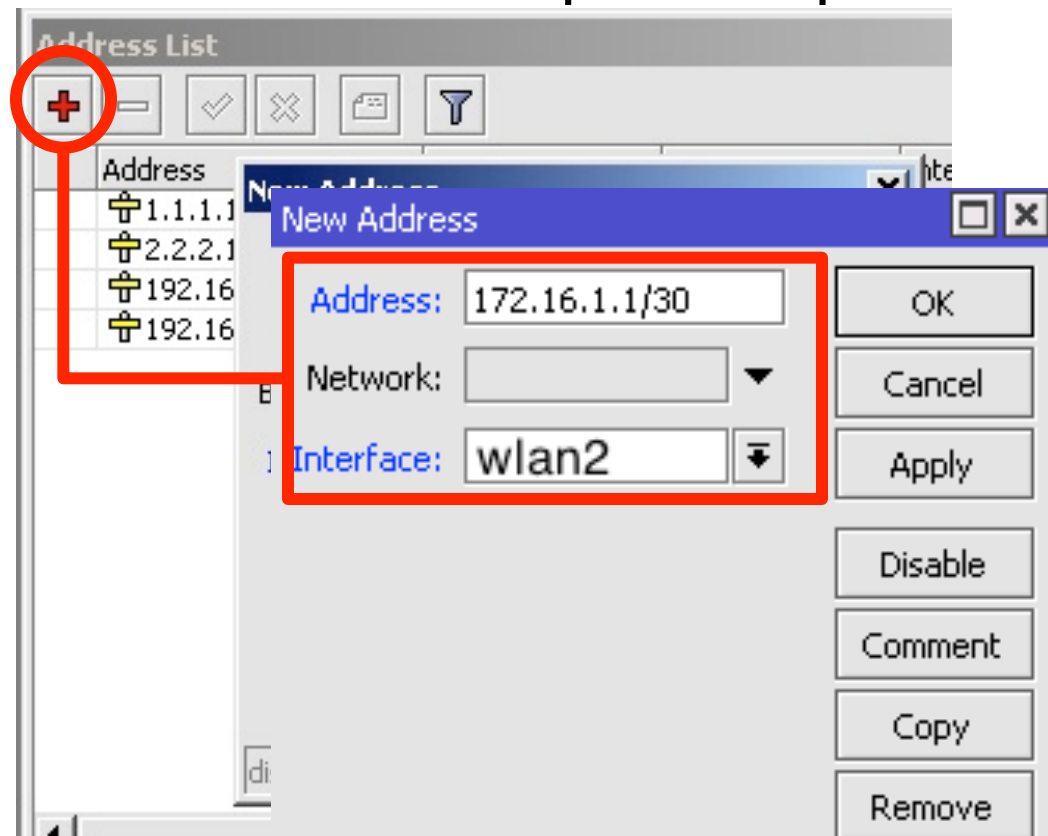

Wireless N Config - Example

Interface <wlan1>

Advanced HT HT MCS WDS Nstreme Tx Power Status ...

HT Tx Chains: 0 (chain0) 1 (chain1)

HT Rx Chains: 0 (chain0) 1 (chain1)

HT Max Rate: 8192

HT AMSDU Threshold: 8192

HT Guard Interval: any

HT Extension Channel: below control

- HT AMPDU Priorities -

<input checked="" type="checkbox"/> 0	<input checked="" type="checkbox"/> 1	<input checked="" type="checkbox"/> 2	<input checked="" type="checkbox"/> 3
<input checked="" type="checkbox"/> 4	<input checked="" type="checkbox"/> 5	<input checked="" type="checkbox"/> 6	<input checked="" type="checkbox"/> 7

Aktifkan **1xMIMO** atau **2xMIMO**

Aktifkan **channel** tambahan

Wireless Bridge

- Mikrotik **Station** mode **can not** tidak bisa langsung dimasukkan ke bridge port (keterbatasan protocol)
- maka?
 - Bisa menggunakan **EoIP** antara **ap-bridge** and **station** – seperti pada lab di materi bridge
 - Pilihan kedua menggunakan mode **WDS-station!** (Throughput drop...).
 - Pilihan ke 3 menggunakan mode baru yaitu **station-pseudobridge**

Wireless Bridge - Implementation

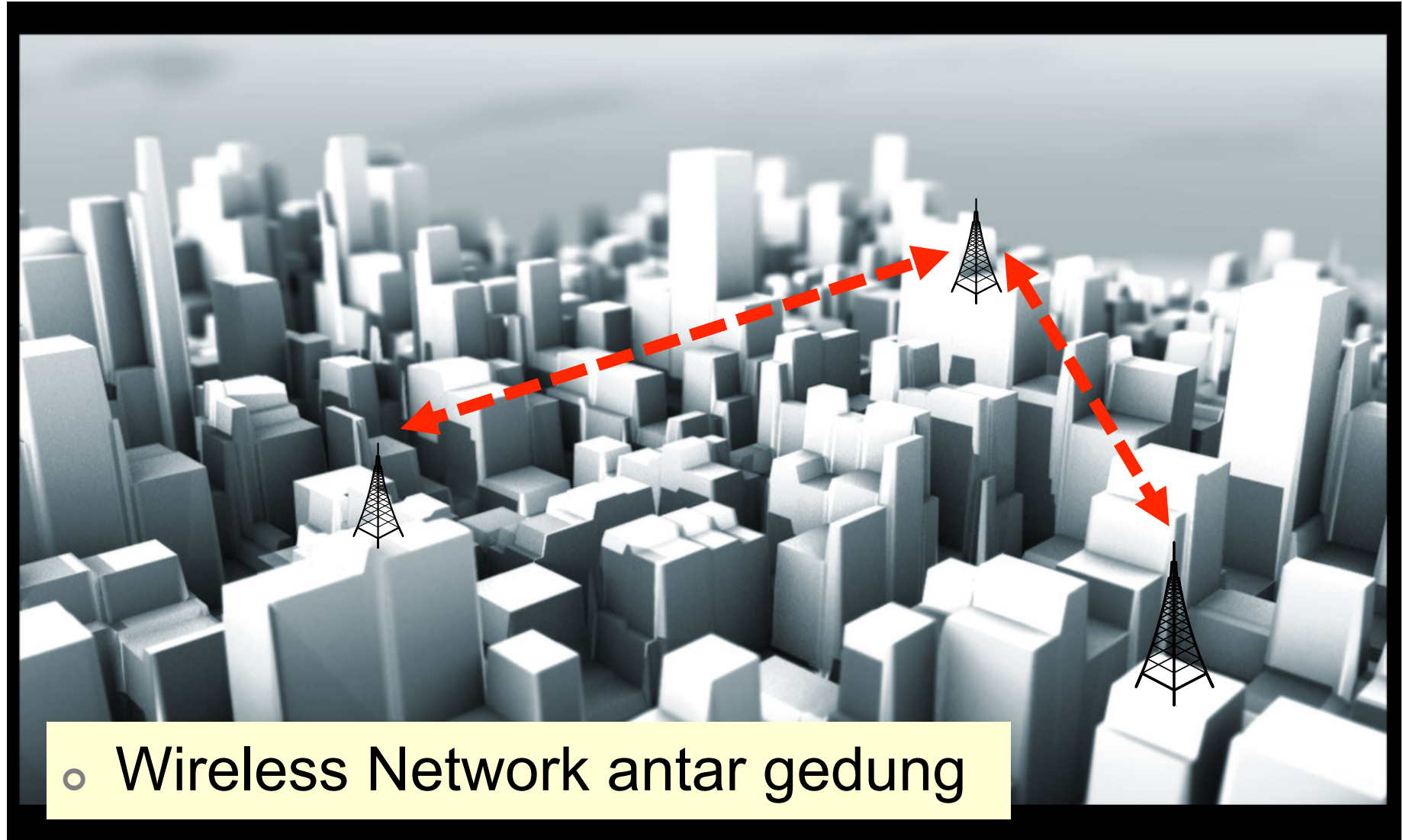

- Wireless Network antar gedung

[LAB-3] Wireless Bridge

- Buatlah konfigurasi **AP** vs **client** yang digunakan untuk Bridge Network via wireless, sisi client menggunakan mode **station-pseudobridge**.
- Setelah wireless sudah terkoneksi masukkan interface wireless Wlan2 ke dalam **Bridge Port** (dilakukan di kedua router). Maka laptop kedua sisi akan menjadi satu segmen.

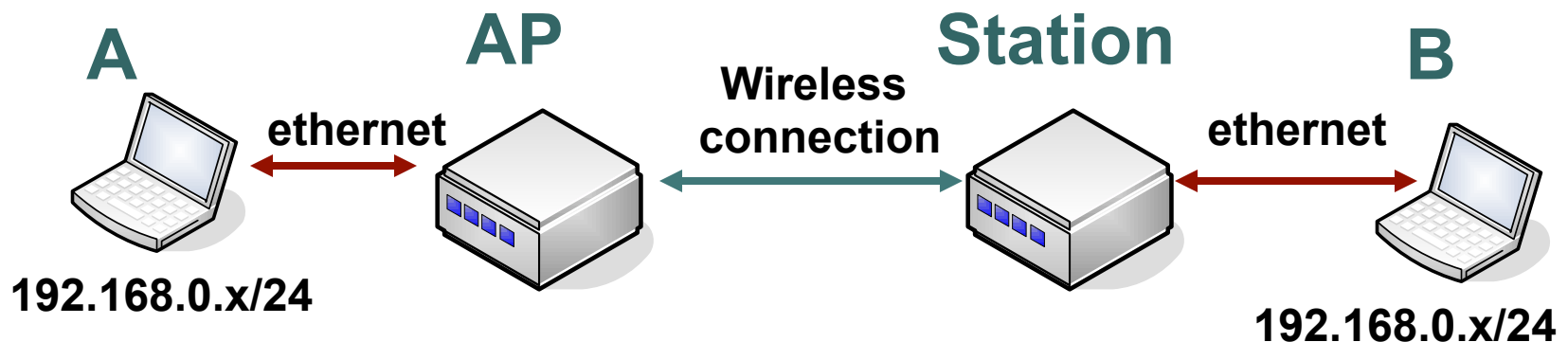

[LAB-3] Wireless Bridge – AP side

- AP Side using Bridge Mode

Interface <wlan2>

General Wireless WDS Nstreme NV2 Status ...

Mode: bridge

Band: 5GHz-A

Channel Width: 20Mhz

Frequency: 5805 MHz

SSID: mejax

Scan List: 5100-5800

[LAB-3] Wireless Bridge – Client side

- Client Side:
 - Set mode= **station-pseudobridge**

Interface <wlan2>

General Wireless WDS Nstreme NV2 Status ...

Mode: station pseudobridge

Band: 5GHz-A

Channel Width: 20Mhz

Frequency: 5180 MHz

SSID: mejax

Scan List: 5100-5800

[LAB-3] Wireless Bridge- Bridge Config

The screenshot displays the Mikrotik WinBox interface for configuring a new bridge. On the left sidebar, the 'Bridge' option is highlighted with a red box. In the main area, the 'Bridge' tab is selected, and a red circle highlights the '+' icon used to add a new bridge. A red line connects this icon to the 'Name' field in the 'New Interface' dialog, which is also highlighted with a red box and contains the text 'bridge1'. Other fields in the dialog include 'Type' set to 'Bridge', 'MTU' set to '1500', 'L2 MTU' (empty), 'MAC Address' (empty), 'ARP' set to 'enabled', and 'Admin. MAC Address' (empty).

[LAB-3] Wireless Bridge – Bridge Ports Config

The screenshot illustrates the configuration of a wireless bridge in Mikrotik WinBox. The 'Bridge' menu is highlighted in red. A '+' icon is circled in red, leading to a 'New Bridge Port' dialog. Two instances of the dialog are shown: one with 'ether1' selected and one with 'wlan2' selected. Both are connected to 'bridge1'. The 'Priority' is 80 and 'Path Cost' is 10.

Bridge Configuration:

- Interface: ether1
- Bridge: bridge1
- Priority: 80
- Path Cost: 10
- Horizon: [Dropdown]

New Bridge Port Configuration:

- Interface: wlan2
- Bridge: bridge1
- Priority: 80 hex
- Path Cost: 10
- Horizon: [Dropdown]

[LAB-4] Point to Multi Point

- Mikrotik difungsikan sebagai access point. Digunakan standart 80211b atau 80211b/g sehingga semua client (berbagai vendor dan berbagai type) dapat terkoneksi.

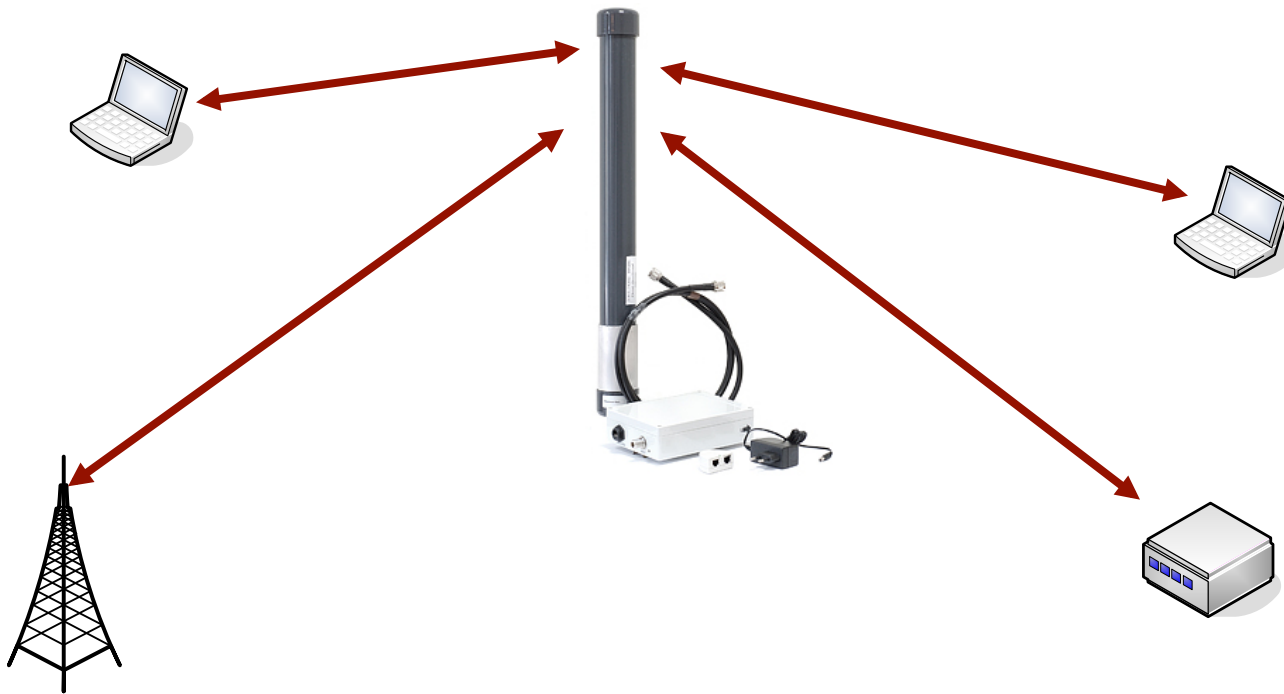

[LAB-4] P2MP – AP Side

- Membutuhkan lisensi level 4
- Set mode=ap-bridge
- Konfigurasi lainnya sama dengan konfigurasi point-to-point

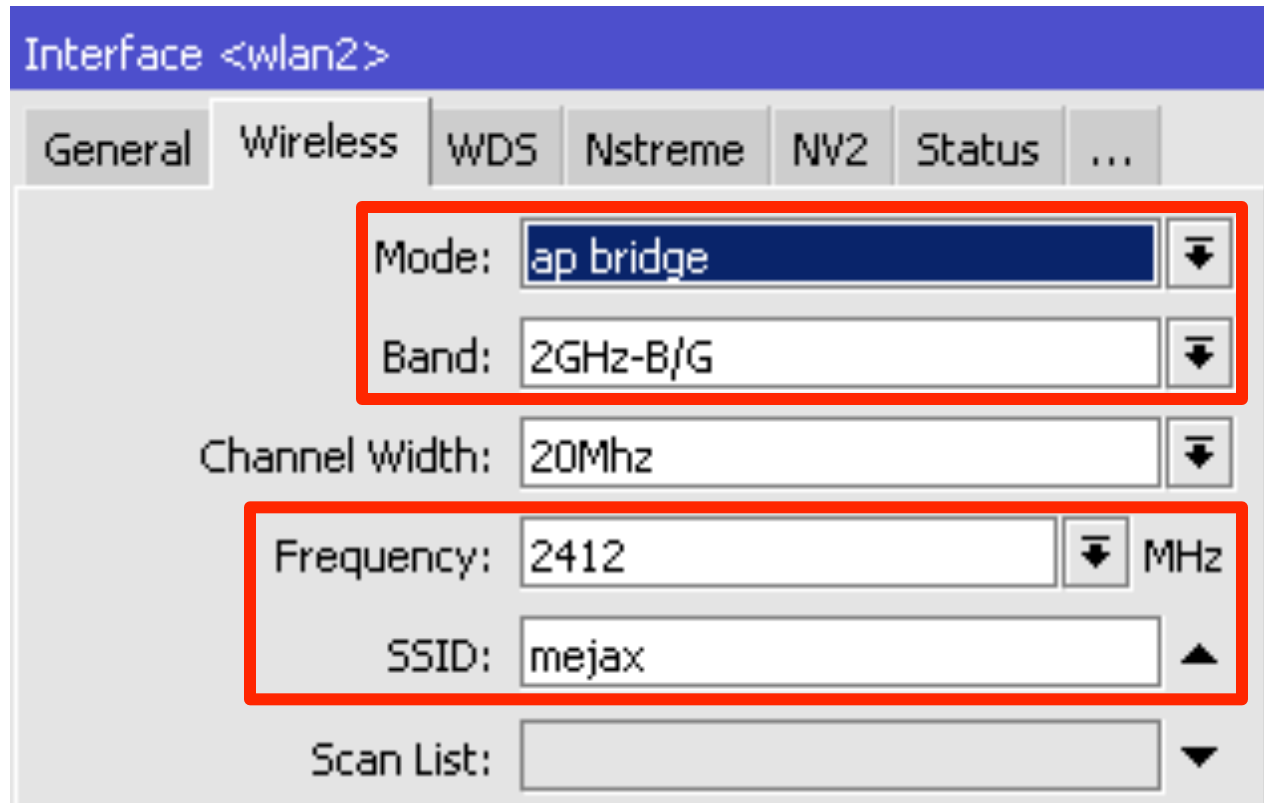

Interface <wlan2>

General Wireless WDS Nstreme NV2 Status ...

Mode: ap bridge

Band: 2GHz-B/G

Channel Width: 20Mhz

Frequency: 2412 MHz

SSID: mejax

Scan List:

Detailed description: This is a screenshot of the Mikrotik WinBox configuration window for the wlan2 interface. The 'Wireless' tab is selected. The 'Mode' dropdown is set to 'ap bridge'. The 'Band' dropdown is set to '2GHz-B/G'. The 'Channel Width' dropdown is set to '20Mhz'. The 'Frequency' dropdown is set to '2412 MHz'. The 'SSID' text field contains 'mejax'. The 'Scan List' dropdown is empty. Two red rectangular boxes highlight the 'Mode' and 'Band' fields, and another red rectangular box highlights the 'Frequency' and 'SSID' fields.

[LAB-4] P2MP – Station Side

- Dapat menggunakan lisensi level 3
- Set mode, ssid, band, scan-list
- Set mode=station

The screenshot shows the Mikrotik WinBox configuration page for the wlan2 interface. The 'Wireless' tab is selected. The configuration is as follows:

Field	Value
Mode	station
Band	2GHz-B/G
Channel Width	20Mhz
Frequency	2412 MHz
SSID	mejax
Scan List	2400-2500

Red boxes highlight the Mode, Band, SSID, and Scan List fields.

Wireless Access Management

- **Access List** – adalah filter autentikasi sebuah AP (AP side) terhadap client yang terkoneksi.
- **Connect List** – adalah filter autentikasi sebuah wireless station (client side) terhadap AP mana yang ingin terkoneksi.
- Rule autentikasi atau filter autentikasi dibaca secara terurut dari atas ke bawah seperti halnya sebuah filter firewall sampai request autentikasi mencapai kecocokan.
- Sangat dimungkinkan untuk memasang beberapa filter untuk mac-address yang sama dan juga satu rule untuk semua mac-address.
- Sebuah rule filter mac-address bisa diterapkan pada sebuah interface wireless saja atau bisa juga untuk semua interface.
- Jika tidak ada rule yang sesuai maka akan digunakan default policy (**default authentication & default forward**) dari wireless interface tersebut.

Client Management

- Kita dapat melakukan pengaturan untuk setiap klien menggunakan :

- Access List :

- MAC Address
- Signal Strength
- Time

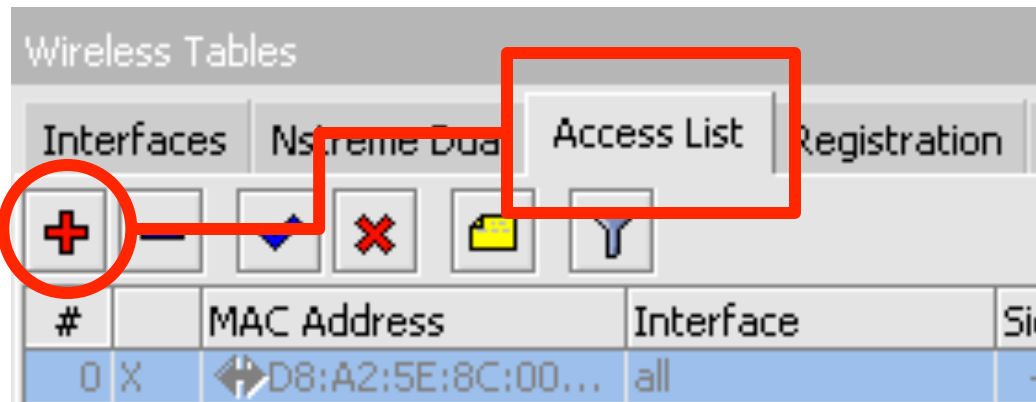

AP Access Rule <D8:A2:5E:8C:00:B9>

MAC Address:

D8:A2:5E:8C:00:B9

Klasifikasi **mac-address**
dari client

Interface:

all

Signal Strength Range:

-120..120

Option **policy** boleh
terkoneksi atau tidak

AP Tx Limit:

x Limit:

Authentication

Forwarding

Option **waktu** untuk
mengaktifkan rule access
list

ate Key:

none

0x

red Key:

Management

Protection Key:

Time

Time: 00:00:00

- 1d 00:00:00

sun

mon

tue

wed

thu

fri

sat

[LAB-5] Access List Mac filter

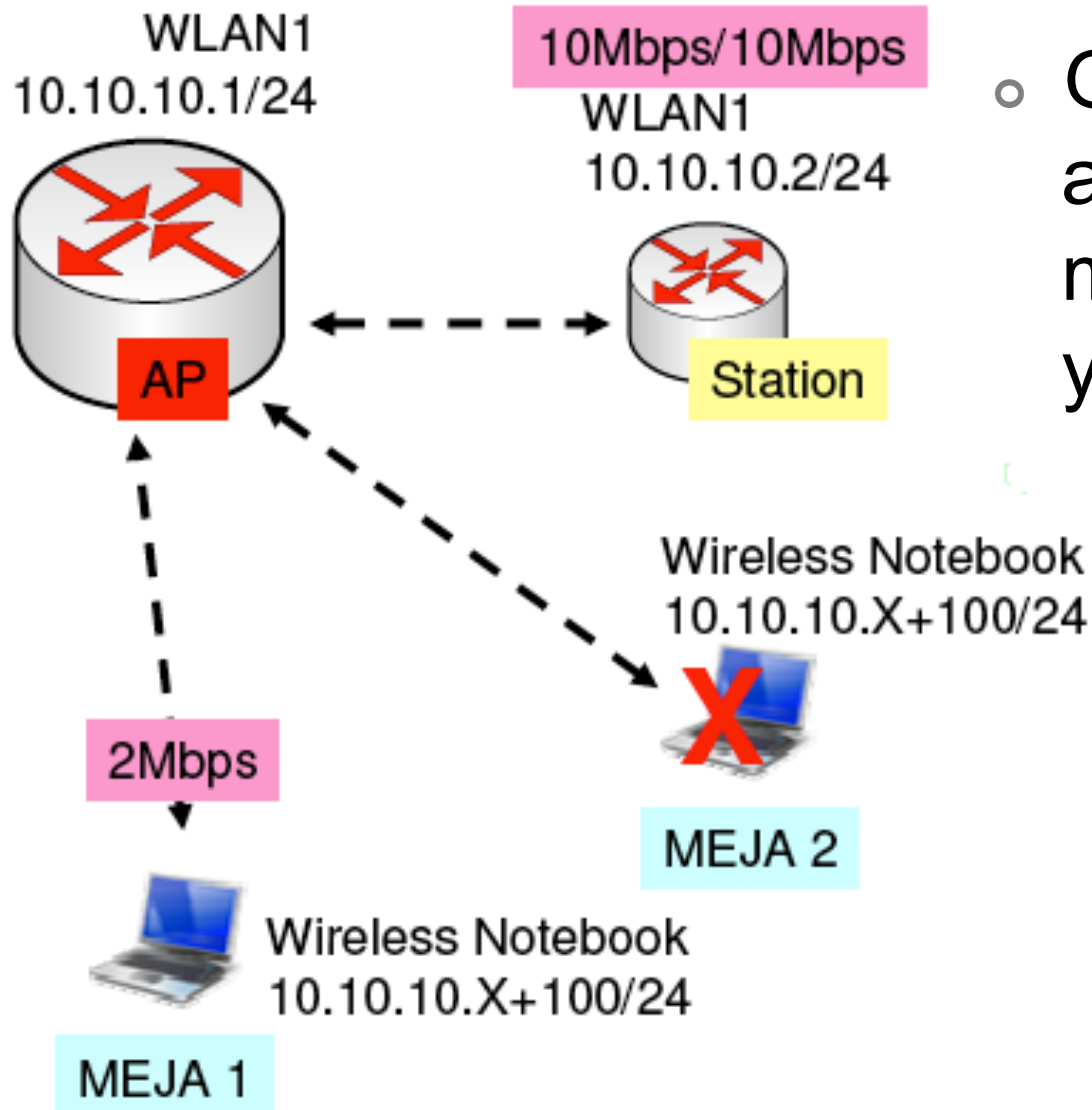

- Gunakan filter Mac-address untuk menentukan client yang terkoneksi.

Wireless Security

- Karena sifat dari wireless yang “open access” maka sebuah access point akan rentan terhadap serangan dari pihak yang tidak bertanggung jawab.
- Sudah saatnya untuk mengimplementasikan Wireless Security untuk menjaga AP tersebut dari berbagai serangan.

Wireless Tables

Interfaces | Nstreme Dual | Access List | Registration | Connect List | **Security Profiles**

+ [Filter Icon]

Name	Mode	Authenticatio...	Unicast Ciphers	Group Ciphers	WPA Pre-Shared ...	WPA2 Pre-Share...
default	none				*****	*****
profile1	dy			tkip aes ccm	*****	*****
profile2	dy			tkip aes ccm	*****	*****

Tambahkan Security Profile

Security Profile <profile1>

General

RADIUS

EAP

Static Keys

Tentukan metode securitynya

Name: profile1

Mode: dynamic keys

Authentication Types

WPA PSK

WPA2 PSK

WPA EAP

WPA2 EAP

Unicast Ciphers

Tentukan passwordnya

aes ccm

Group Ciphers

tkip

aes ccm

WPA Pre-Shared Key: mikrotik1

WPA2 Pre-Shared Key: mikrotik2

General Wireless HT HT MCS WDS Nstreme ...

Mode: ap bridge

Band: 2GHz-B/G/N

Channel Width: 20Mhz

Frequency: 2442 MHz

SSID: mejax

Wireless Protocol: unspecified

Security Profile: default

Bridge Mode: profile1 profile2

Pasang security pada interface

[LAB-6] WPA Lab

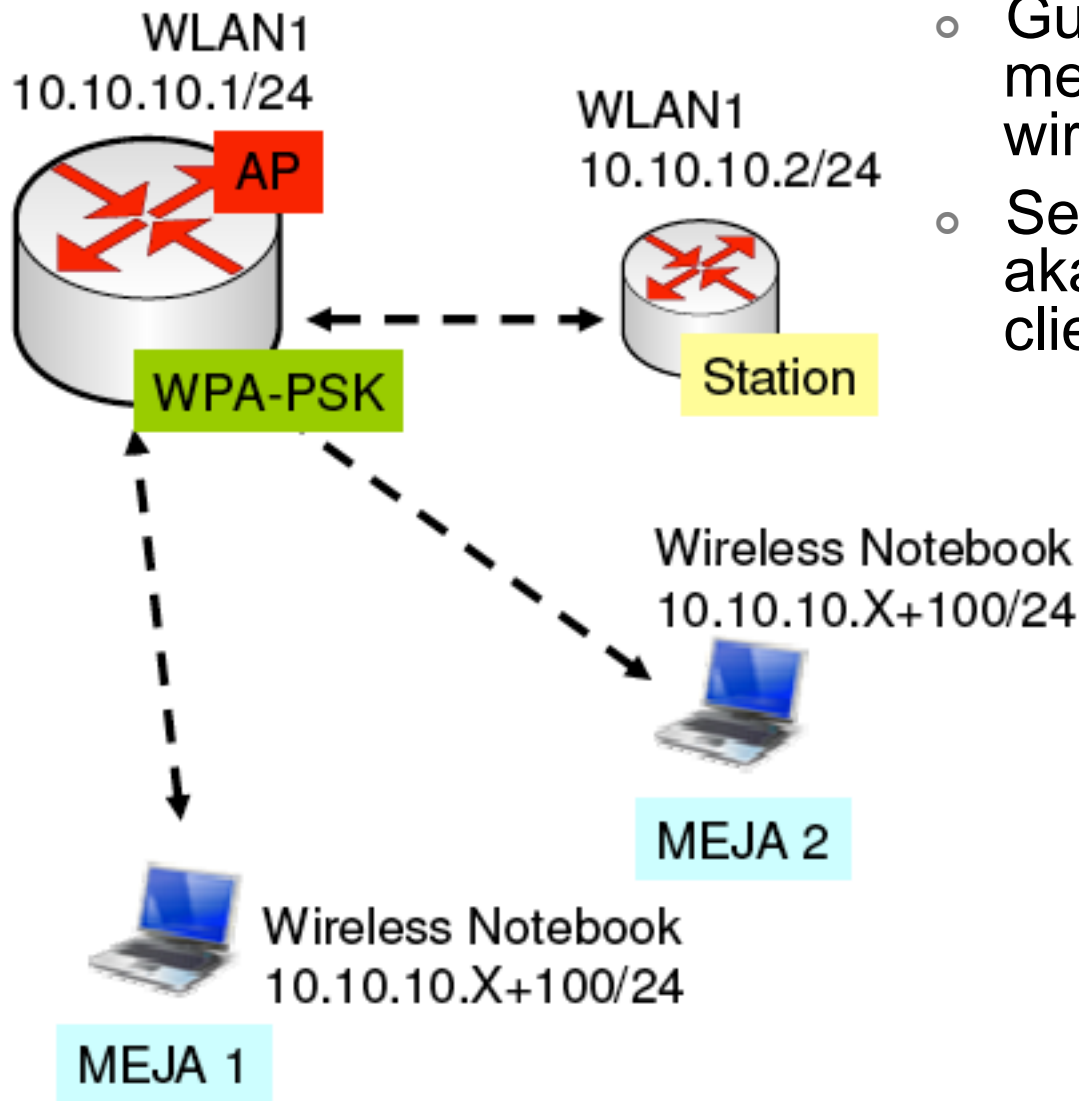

- Gunakan WPA-PSK untuk mengamankan jaringan wireless.
- Security profile pada interface akan mempengaruhi semua client.

Wireless Protocol - VAP

- Virtual Access Point (VAP) interface digunakan untuk membuat AP tambahan dari satu interface wireless yang ada di mikrotik.
- Virtual AP dianggap sebagai interface wireless yang independen dan bisa memiliki konfigurasi berbeda :
 - **SSID**
 - **Mac-Address**
 - **IP Address**
 - **WDS**
 - **Security Profile**
- Sedangkan untuk konfigurasi wireless **Mode**, **Band**, **Frequency** serta **Nstreme** tetap mengambil dari interface wireless master.
- Bisa diibaratkan seperti VLAN di wireless.

[LAB-7] Virtual AP Lab

Buat Virtual AP, dan
cermati hasil scan di laptop

New Interface

General Wireless WDS Status Traffic

Name: wlan3

Type: VirtualAP

MTU: 1500

L2 MTU:

MAC Address: 00:00:00:00:00:00

ARP: enabled

New Interface

General Wireless WDS Status Traffic

SSID: meja-xx-virtual

Master Interface: wlan2

Security Profile: default

Default AP Tx Rate: bps

Default Client Tx Rate: bps

Default Authenticate

Default Forward

Hide SSID

Wireless Protocol - Nstreme

- Nstreme adalah wireless protocol yang **MikroTik's proprietary** (protocol yang tidak kompatibel dengan vendor lain), yang digunakan untuk meningkatkan unjuk kerja jaringan wireless point-to-point maupun point-to-multipoint.
- Hanya bisa dilaktifkan di AP dan Client Mikrotik, tidak disupport oleh perangkat wireless brand lain.

Mikrotik Nstreme

- Keuntungan dari penggunaan Nstreme protocol :
- **Client polling** – melakukan kontrol terhadap jaringan wireless point-to-multipoint dengan mengaktifkan client polling (menyerupai sebuah AP menggunakan kontrol TokenRing).
- **Disable CSMA.**
- Tidak ada limitasi protocol (ACK timeout) di link wireless jarak jauh.
- Beban protocol di tiap frame data akan menjadi lebih ringan sehingga akan mempermudah untuk mendapatkan data-rate yang tinggi.
- Tidak ada lagi protocol yang menyebabkan penurunan kecepatan data-rate untuk link jarak jauh.

[LAB-9] Nstreme

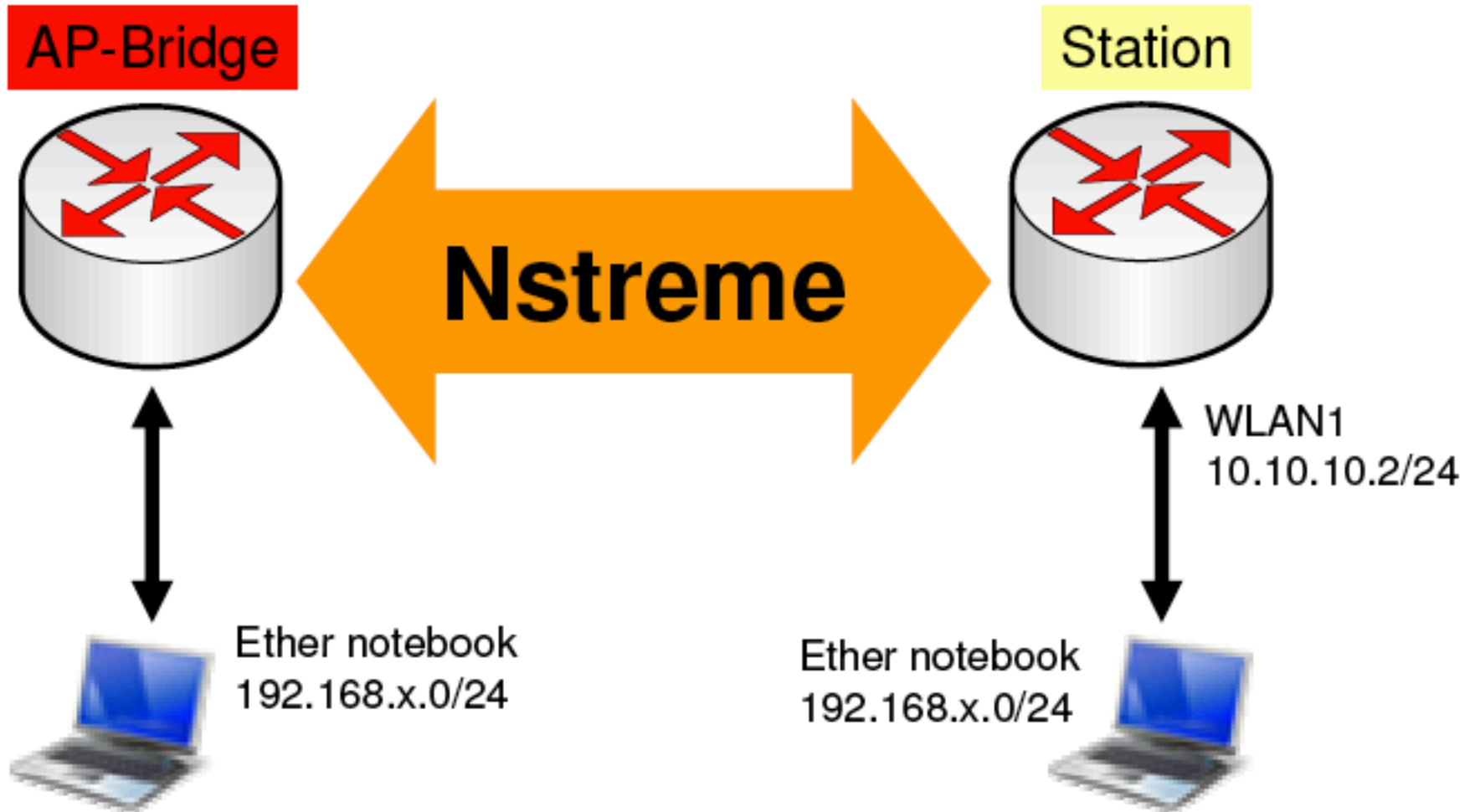

Activate Nstreme on AP & Client

Interface <wlan2>

General Wireless Data Rates Advanced WDS ...

Mode:

Band:

Channel Width:

Frequency:

SSID:

Radio Name:

Scan List:

Wireless Protocol:

Security Profile:

Interface <wlan2>

WDS Nstreme NV2 Tx Power Current Tx Power ...

Enable Nstreme

Enable Polling

Disable CSMA

Framer Policy:

Framer Limit:

Nstreme - Results

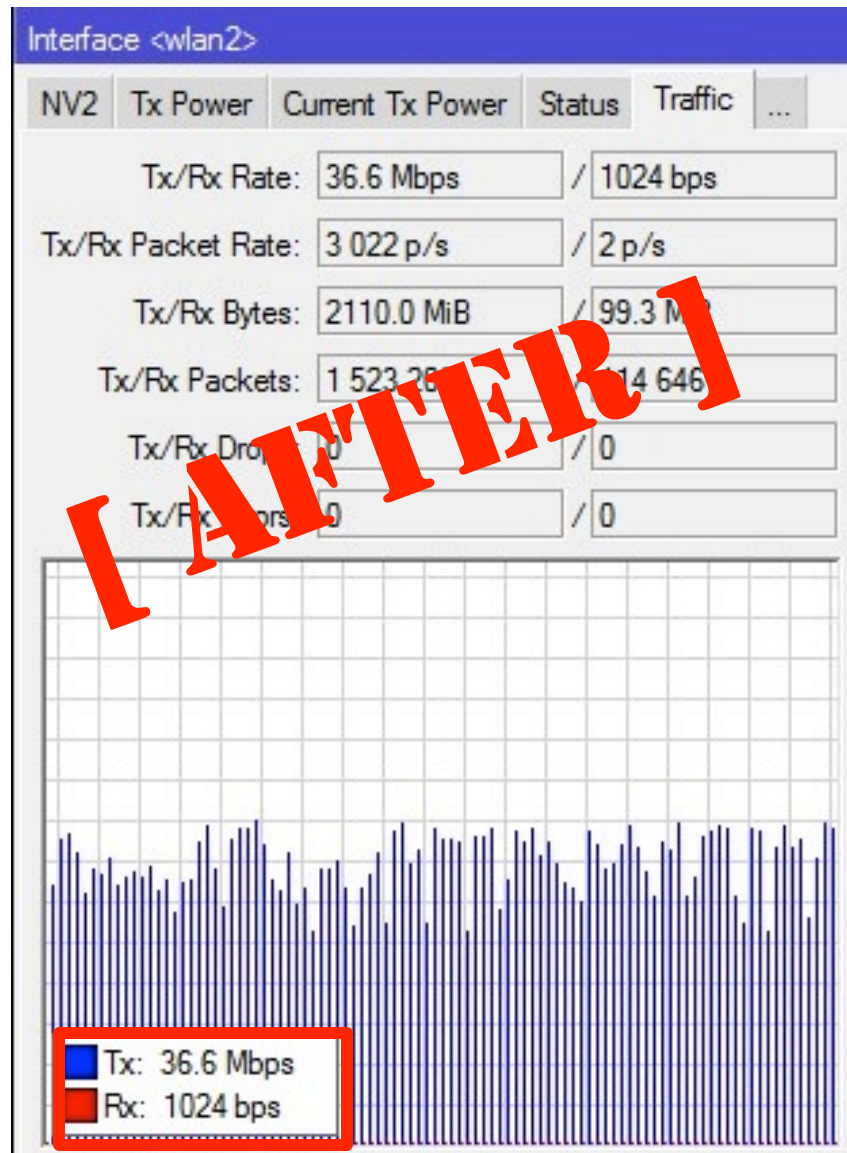
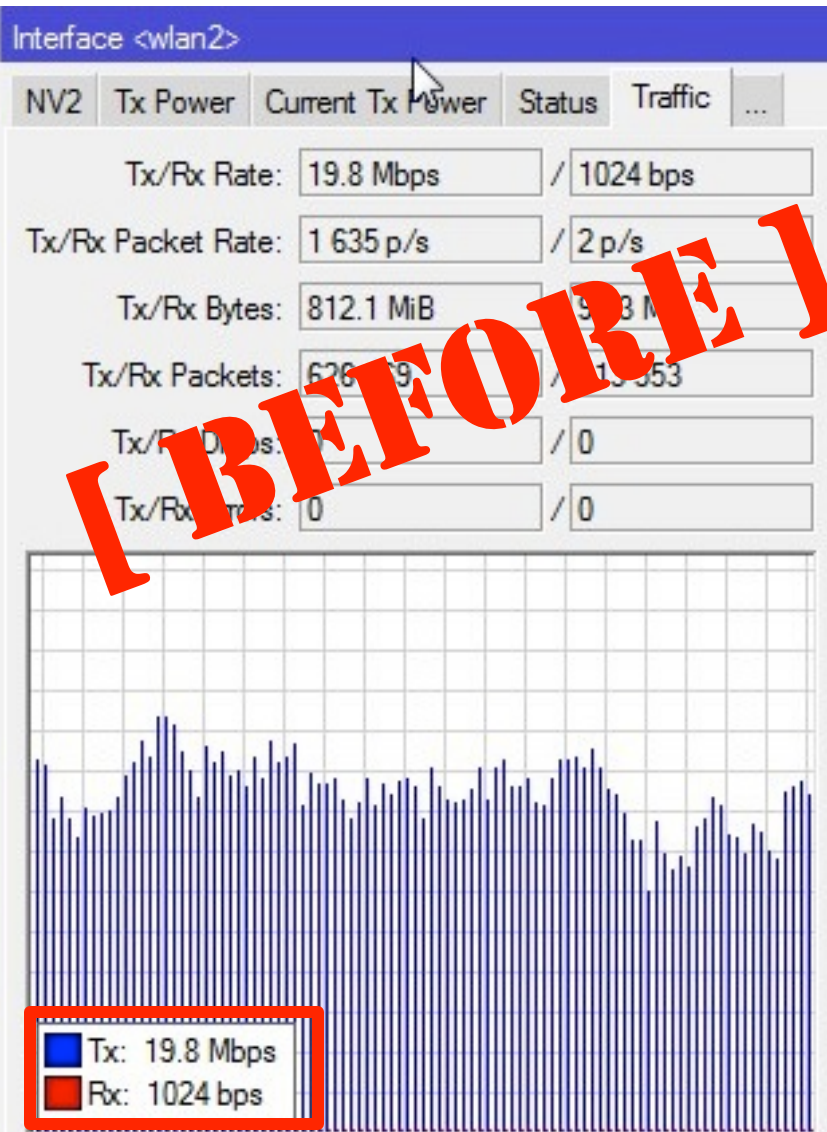

● ● ● | **WDS – Wireless Distribution System**

- Dengan menggunakan **WDS** system memungkinkan untuk melakukan konfigurasi wireless yang sedikit berbeda untuk **meningkatkan jangkauan area jaringan wireless**. Dengan menggunakan beberapa perangkat **AP** menjadi sebuah satu kesatuan.
- Dengan menggunakan WDS ini memungkinkan komunikasi data melewati beberapa AP seperti halnya sebuah jaringan ethernet, bisa diibaratkan perangkat AP tersebut sebagai sebuah switch.
- Beberapa AP yang tergabung di dalam Jaringan WDS harus menggunakan **band, frequency** dan **SSID** yang sama.

Wireless WDS

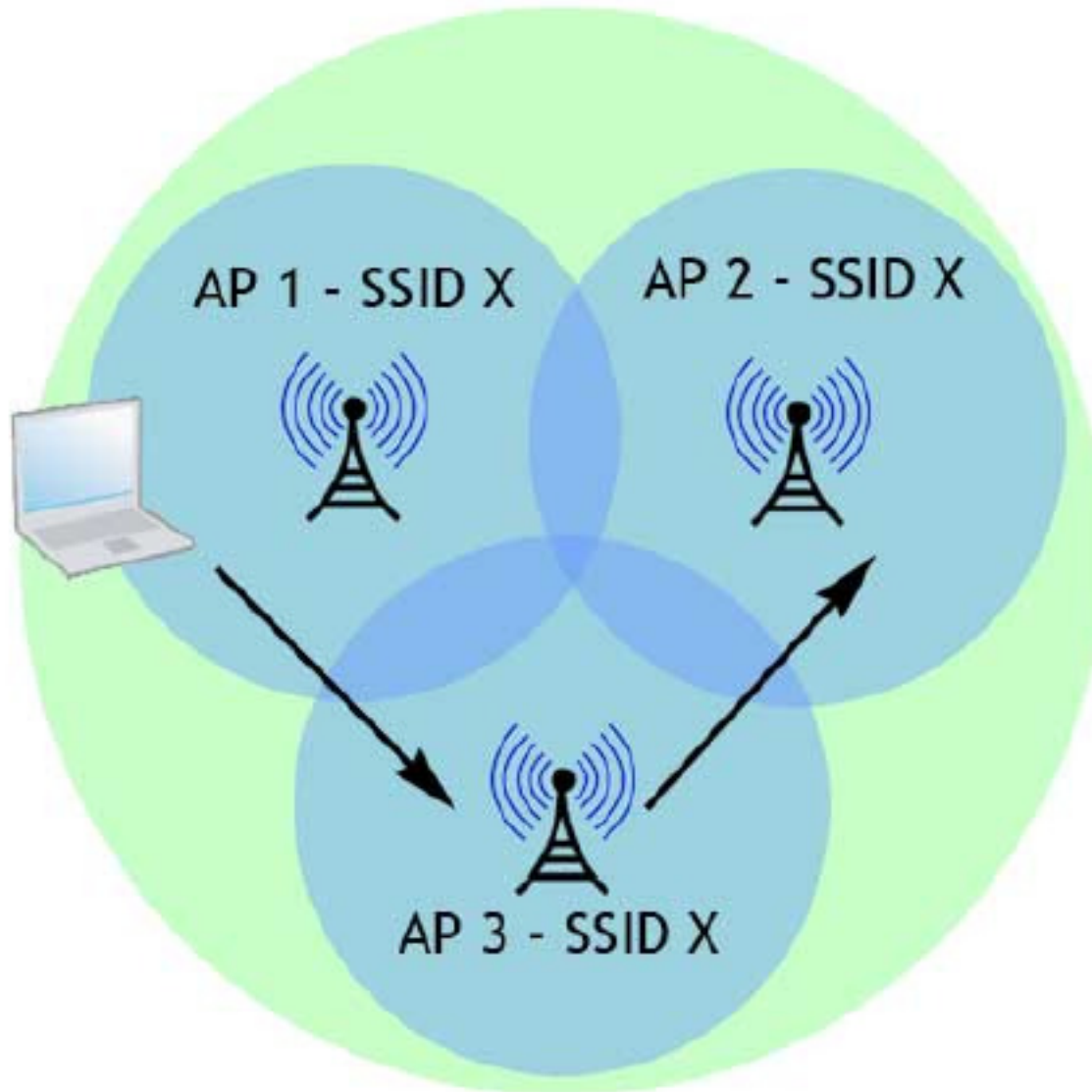

WDS - Config

Buat **Bridge** baru untuk WDS Network

Name: bridge-wds

Konfigurasi **Wlan2** untuk mengaktifkan **Protocol WDS**

WDS Mode: dynamic

WDS Default Bridge: bridge-wds

WDS Ignore SSID

New Interface

General STP Status Traffic

Name: bridge-wds

Type: Bridge

MTU: 1500

L2 MTU:

MAC Address:

HT HT MCS WDS Nstream NV2 Status Traffic ...

WDS Mode: dynamic

WDS Default Bridge: bridge-wds

WDS Ignore SSID

[LAB-9] WDS – Multi AP

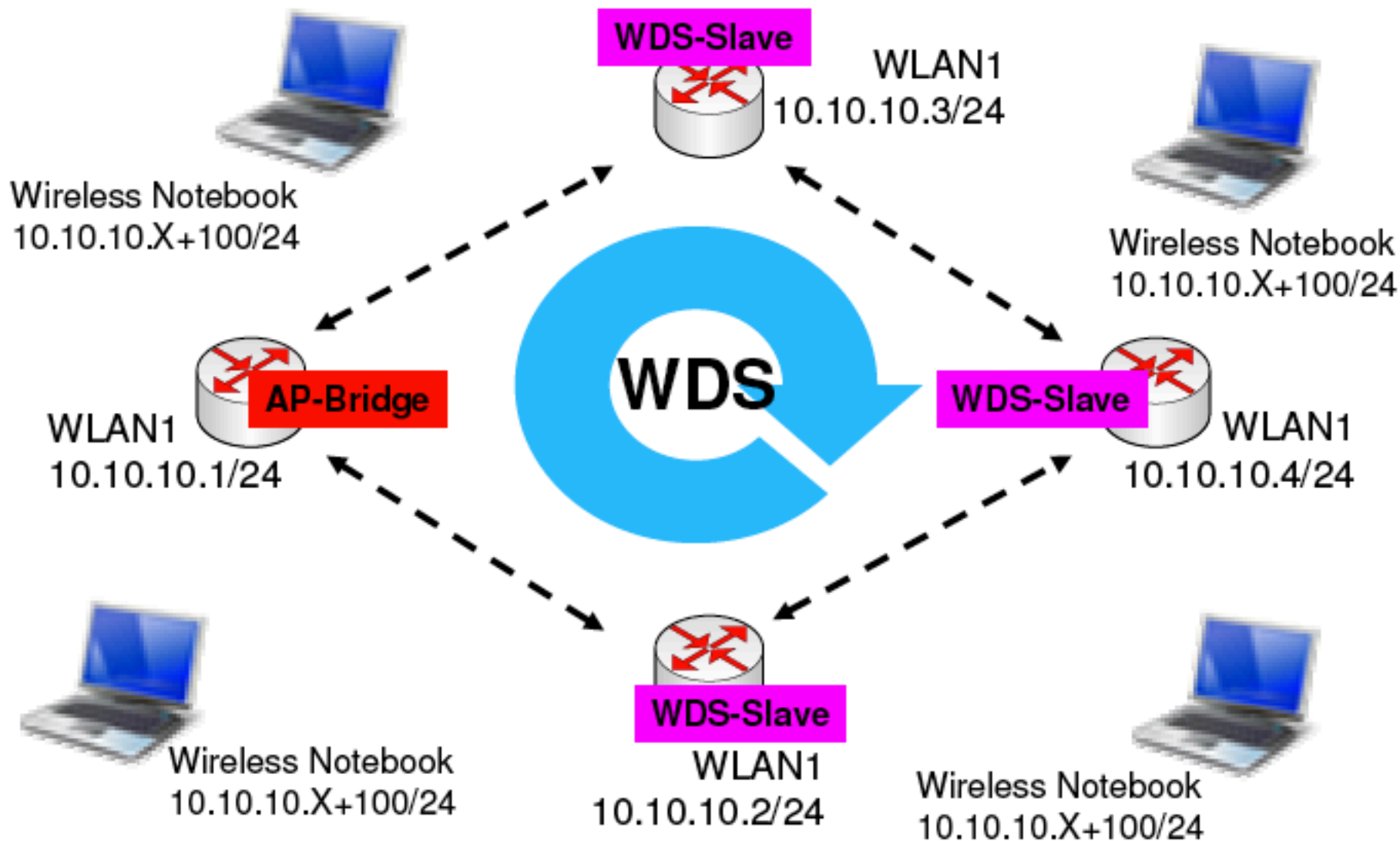



Routing



Certified Mikrotik Training Basic Class

Organized by: **Citraweb Nusa Infomedia**

(Mikrotik Certified Training Partner)



Routed Network

- **Routing** - Pengaturan jalur antar Segment Network yang berbeda berdasarkan IP Address tujuan (atau bisa juga asal).
- Bekerja pada OSI layer 3 (Network).
- Untuk menghubungkan network yang berbeda segment (subnet) memerlukan sebuah perangkat yang mampu melakukan proses routing yang disebut dengan Router.

Routing Example

- Routerboard yang berfungsi sebagai router akan menjembatani komunikasi antar network yang berbeda

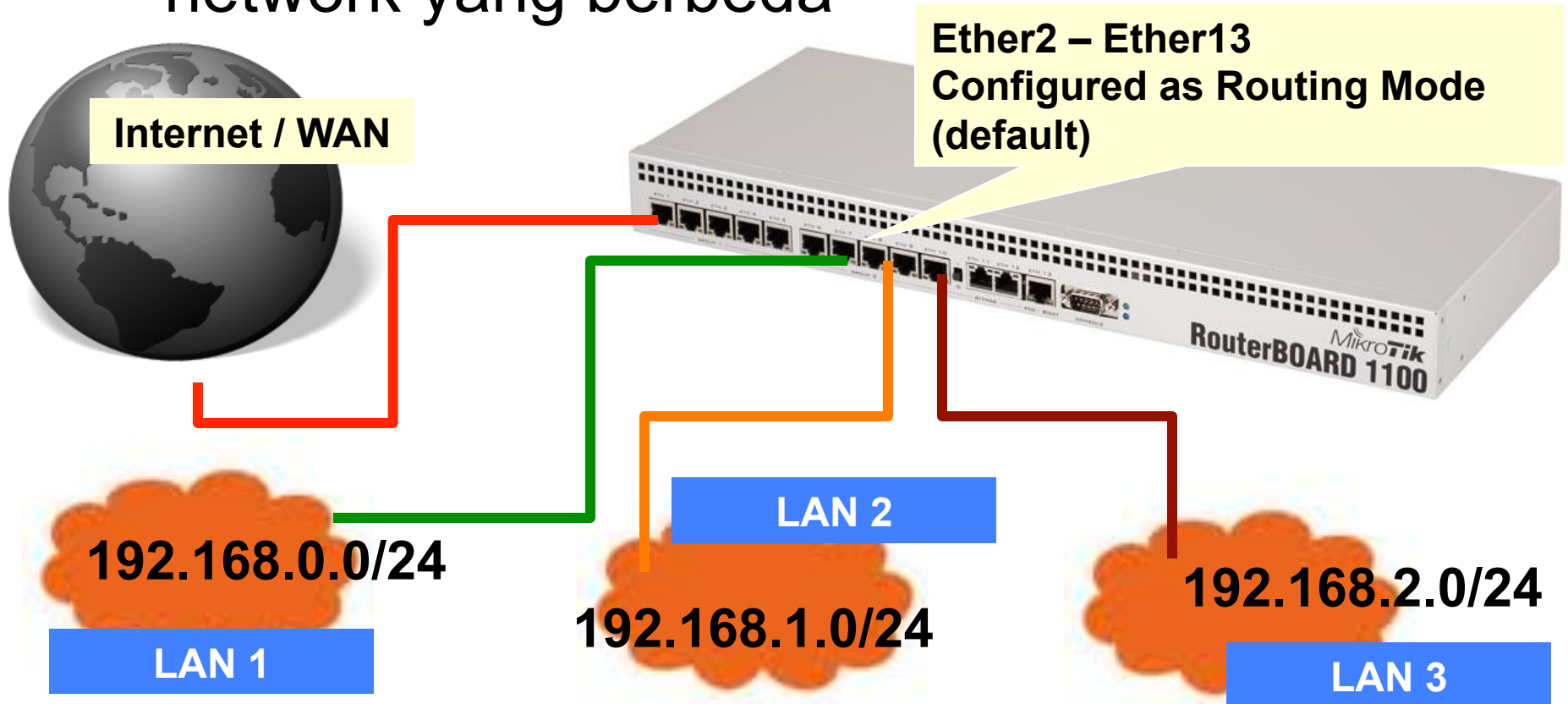



Routing Benefit

- Memungkinkan kita melakukan pemantauan dan pengelolaan jaringan yang lebih baik.
- Lebih aman (firewall filtering lebih mudah).
- Trafik broadcast (Virus) hanya terkonsentrasi di local network segmen yang sama.
- Untuk network skala besar, Routing bisa diimplementasikan menggunakan Dynamic Routing protocol (RIP/OSPF/BGP)

More Routing – for Wireless

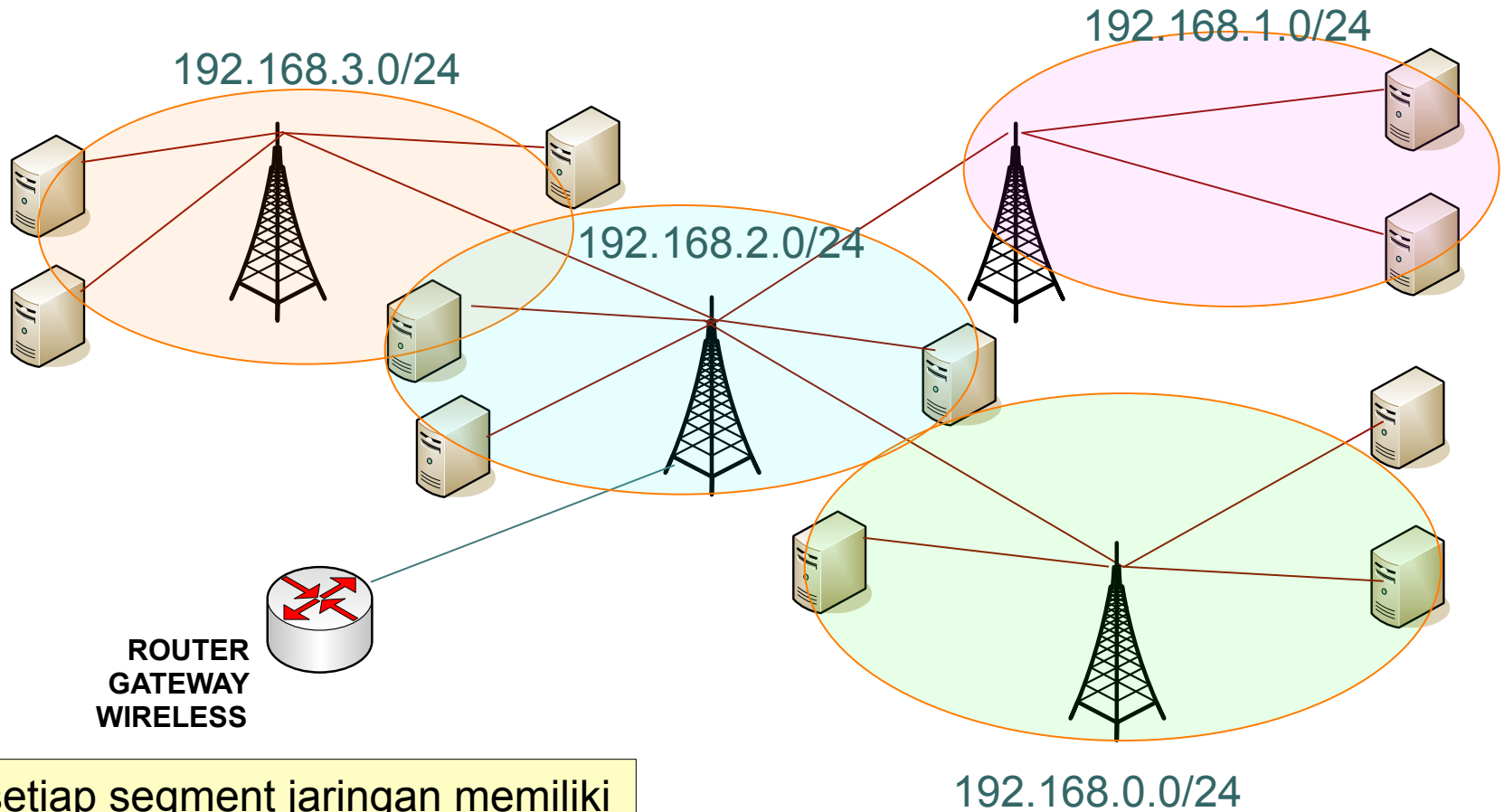

setiap segment jaringan memiliki subnet IP address yang berbeda.

● ● ● | Tipe Informasi Routing

- MikroTik RouterOS tipe routing sbb:
 - **dynamic routes**
yang akan dibuat secara otomatis:
 - saat menambahkan IP Address pada interface
 - informasi routing yang didapat dari protokol routing dinamik seperti RIP, OSPF, dan BGP.
 - **static routes**
adalah informasi routing yang dibuat secara manual oleh user untuk mengatur ke arah mana trafik tertentu akan disalurkan. Default route adalah salah satu contoh static routes.

Menambahkan Routing

The screenshot displays the Mikrotik WinBox interface. On the left, the 'IP' menu is selected, and the 'Routes' sub-menu is highlighted. The main window shows the 'Route List' window, which contains a table of existing routes. A red arrow points to the '+' icon in the 'Route List' window, indicating the action to add a new route. The 'Route <0.0.0.0/0>' configuration window is open, showing the following fields:

Field	Value
Destination	0.0.0.0/0
Gateway	10.10.10.100
Gateway Interface	
Interface	wlan1
Check Gateway	
Type	unicast
Distance	1
Scope	255
Target Scope	10
Routing Mark	
Pref. Source	

Tipe Routing

A: Active
S: Static

A: Active
D: Dynamic
C: Connected

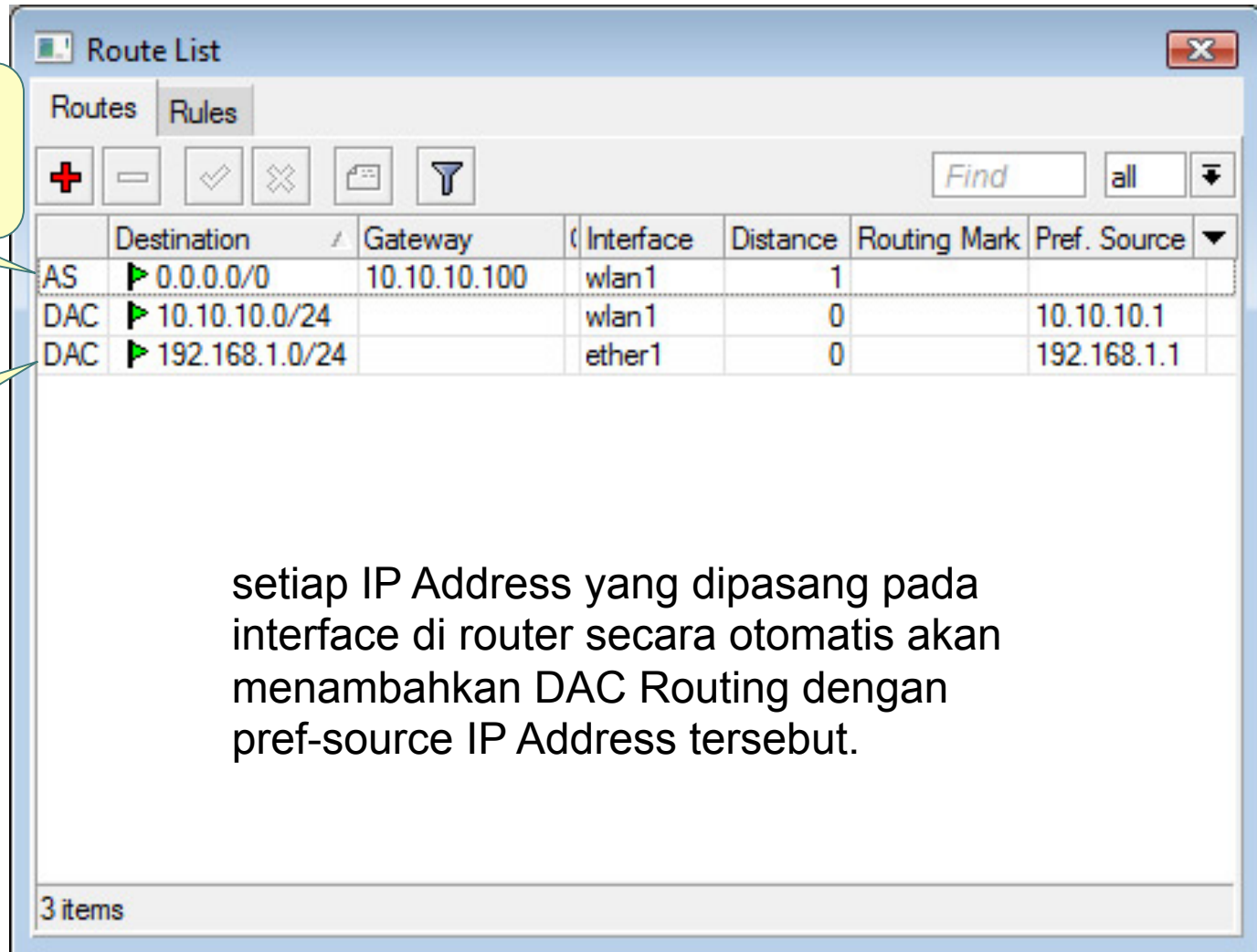

The screenshot shows the 'Route List' window in Mikrotik WinBox. It displays a table of routes with columns for Destination, Gateway, Interface, Distance, Routing Mark, and Pref. Source. The routes are:

	Destination	Gateway	Interface	Distance	Routing Mark	Pref. Source
AS	0.0.0.0/0	10.10.10.100	wlan1	1		
DAC	10.10.10.0/24		wlan1	0		10.10.10.1
DAC	192.168.1.0/24		ether1	0		192.168.1.1

3 items

setiap IP Address yang dipasang pada interface di router secara otomatis akan menambahkan DAC Routing dengan pref-source IP Address tersebut.



Parameter Dasar Routing

- **Destination**
 - Destination address – 222.152.211.7
 - Network mask – 202.53.246.0/24
 - 0.0.0.0/0 -> ke semua network
- **Gateway**
 - IP Address gateway, harus merupakan IP Address yang satu subnet dengan IP yang terpasang pada salah satu interface
- **Gateway Interface**
 - Digunakan apabila IP gateway tidak diketahui dan bersifat dinamik (biasanya digunakan di **ppp** interface).
- **Pref Source**
 - source IP address dari paket yang akan meninggalkan router
- **Distance**
 - Beban untuk kalkulasi pemilihan routing

Konsep Dasar Routing

- IP Address Gateway harus merupakan IP Address yang subnetnya sama dengan salah satu IP Address yang terpasang pada router (connect directly).

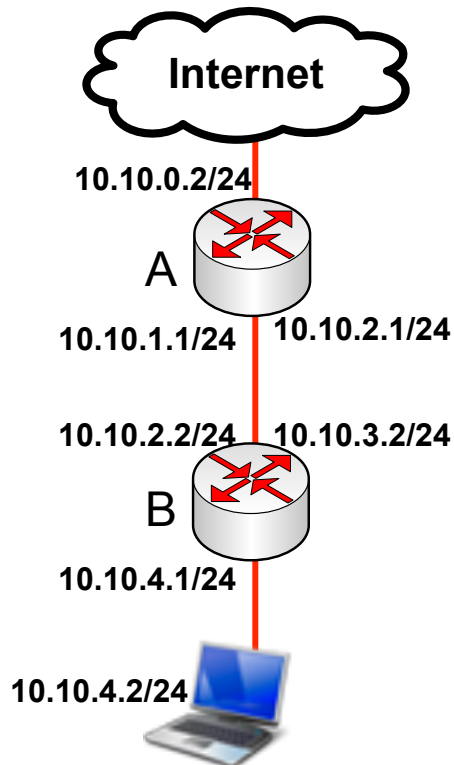

- Pada interface yang menghubungkan router A dan B, pada masing-masing router terdapat lebih dari 1 buah IP Address.
- Default gateway pada router B adalah router A
- IP Address yang menjadi default gateway router B adalah 10.10.2.1, karena IP Address tersebut berada dalam subnet yang sama dengan salah satu IP Address pada router B (10.10.2.2/24)
- Setting static route default :
 - Dst-address=0.0.0.0/0 gateway=10.10.2.1

Implementasi Konsep Routing

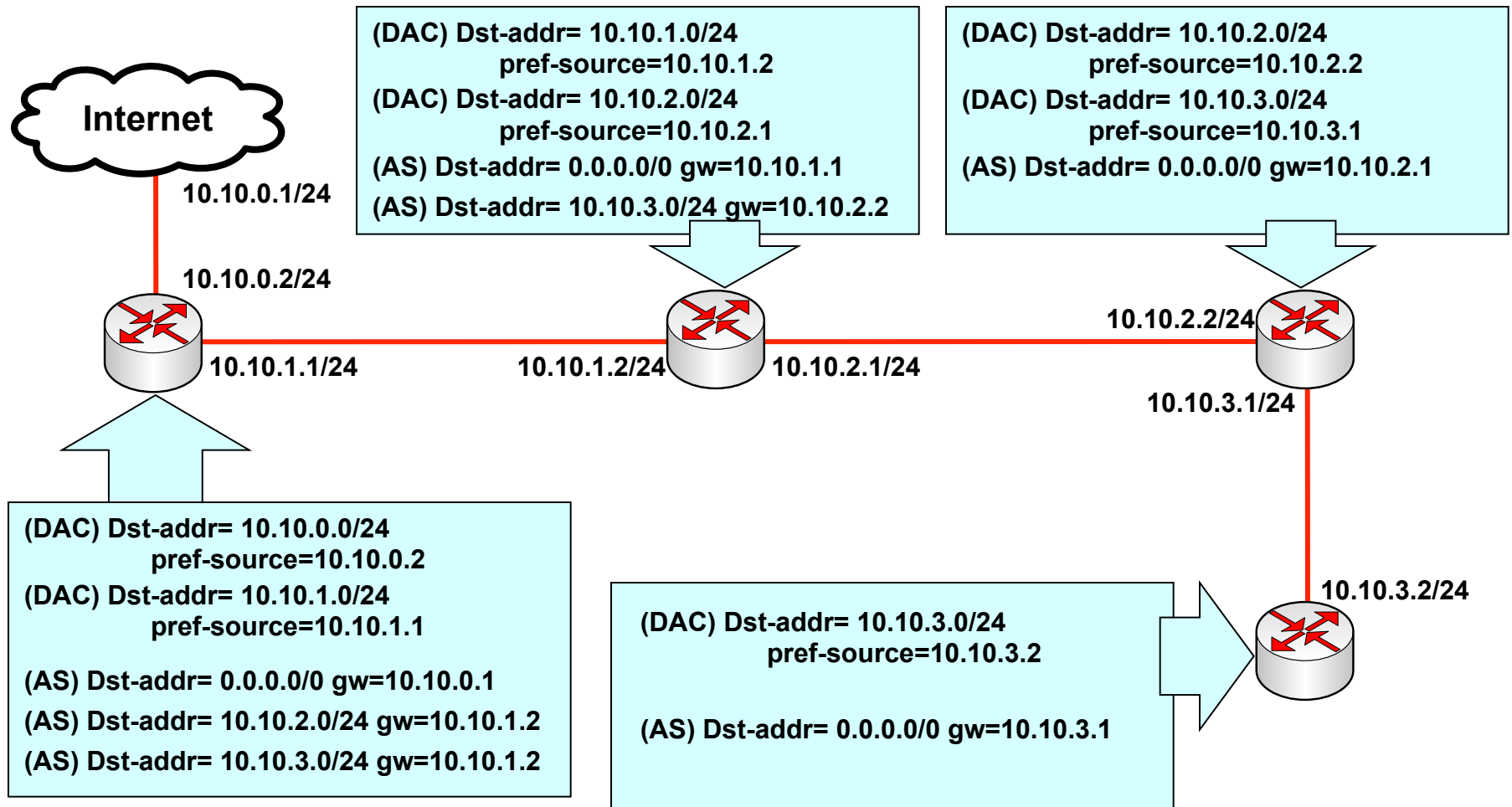

[LAB-1] Static Route

- Dari konfigurasi lab hari 1, semua router hanya memiliki default gateway.
- Tambahkan rule static route supaya ping bisa dilakukan antar notebook yang berbeda network.

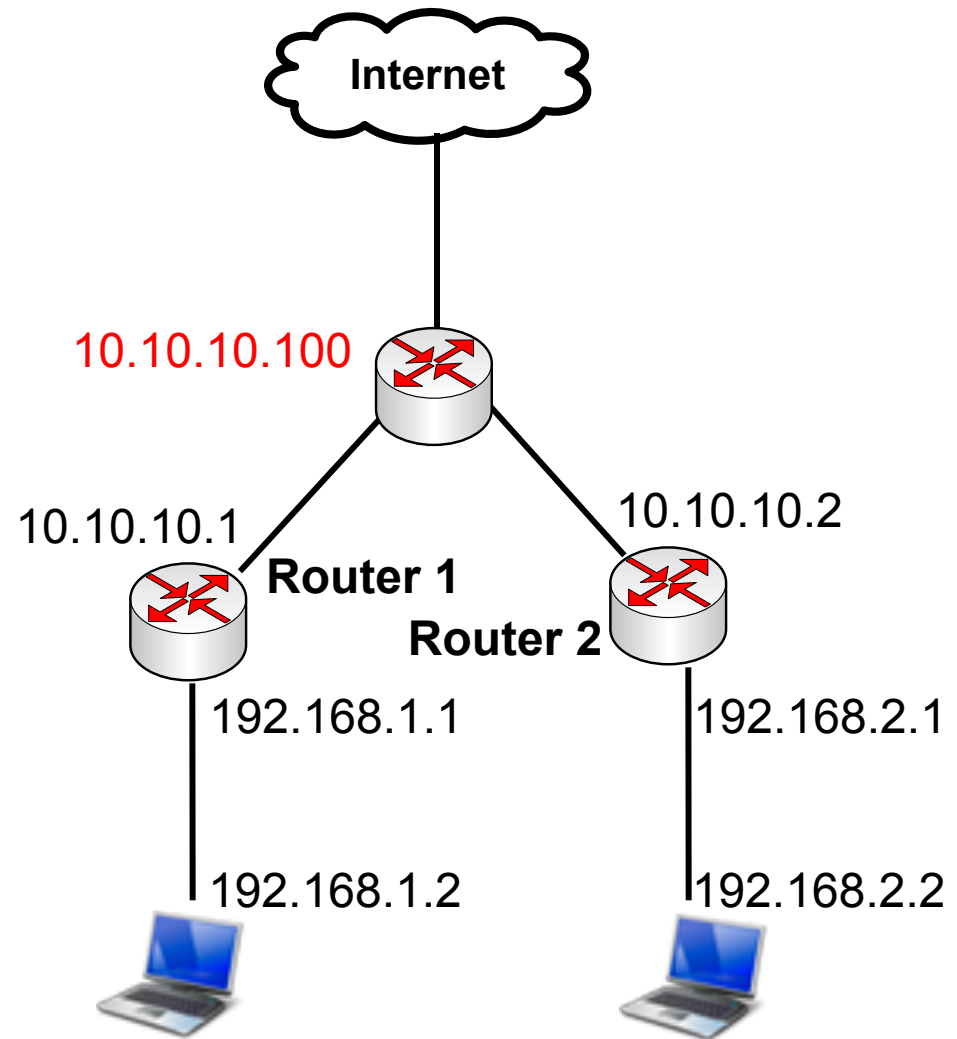

Langkah-langkah

- Matikanlah ! src-nat masquerade
- Buatlah static route pada kedua router
- Contoh di meja 1 untuk membuat static route ke meja 2:
 - /ip route add dst-address=192.168.2.0/24 gateway=10.10.10.2
- Contoh di meja 2 untuk membuat static route ke meja 1:
 - /ip route add dst-address=192.168.1.0/24 gateway=10.10.10.1

Dasar Pemilihan Routing

- Untuk pemilihan routing, router akan memilih berdasarkan:
 - Rule routing yang paling spesifik tujuannya
 - Contoh: destination 192.168.0.128/26 lebih spesifik dari 192.168.0.0/24
 - Distance
 - Router akan memilih yang distance nya paling kecil
 - Round robin (random)

Contoh Pemilihan

- o Untuk koneksi dengan destination 192.168.0.1, manakah urutan prioritas rule yang digunakan?

Destination	Gateway	Distance	Prioritas
192.168.0.0/27	192.168.1.1	1	2
192.168.0.0/29	192.168.2.1	1	1
192.168.0.0/24	192.168.3.1	5	4
192.168.0.0/24	192.168.4.1	1	3

[LAB-2] Static Route

192.168.X.2/24

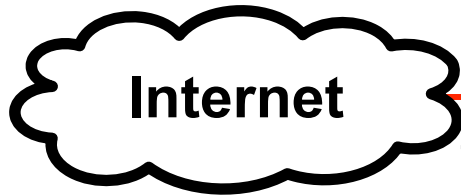

10.10.10.100/24

WLAN1:10.10.10.X/24

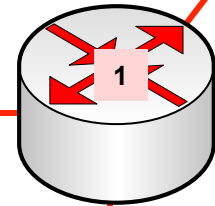

ETHER3:
10.Y.1.1/24

ETHER2:
10.Y.1.2/24

Buatlah konfigurasi berikut dan lakukan pengaturan static route sehingga semua laptop dapat terkoneksi ke internet dan semua laptop dapat melakukan ping ke laptop lainnya. Matikanlah src-nat/masquerade.

ETHER3:
10.Y.2.1/24

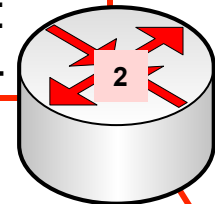

ETHER3:
10.Y.3.1/24

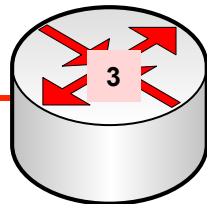

ETHER2:
10.Y.3.2/24

ETHER2:
10.Y.2.2/24

192.168.X.2/24



192.168.X.2/24



192.168.X.2/24



Dynamic Routing

- Karena sebuah jaringan memiliki besar skala yang berbeda satu sama lain, maka sangat memungkinkan jika jaringan tersebut berkembang menjadi besar sekali. Maka penggunaan routing menjadi sangat penting dan kritis.
- **Informasi routing haruslah tepat** dan kesalahan melakukan distribusi informasi routing harus diminimalisasi sedikit mungkin.
- Sangatlah tidak nyaman jika harus menuliskan rule routing untuk puluhan bahkan ratusan router secara static.

● ● ● | **Very Big Network**

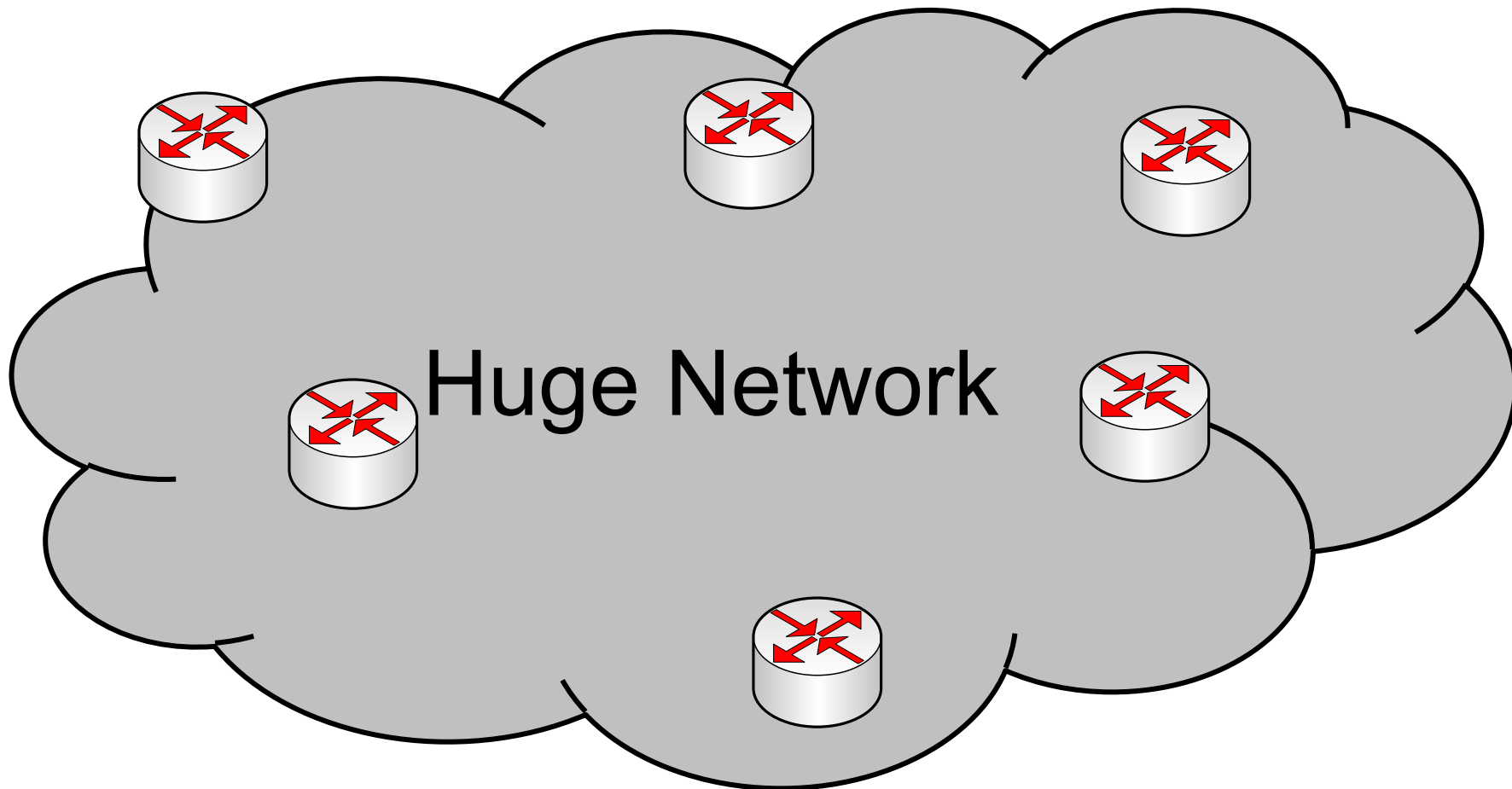

Dynamic Routing - OSPF

- **OSPF** merupakan sebuah routing protokol yang dapat mendistribusikan informasi routing secara otomatis.
- OSPF juga merupakan *routing* protokol yang menggunakan konsep hirarki *routing*, dengan kata lain OSPF juga mampu membagi-bagi jaringan menjadi beberapa tingkatan. Tingkatan-tingkatan ini diwujudkan dengan menggunakan sistem pengelompokan yaitu **area**.

[LAB-3] Konfigurasi OSPF

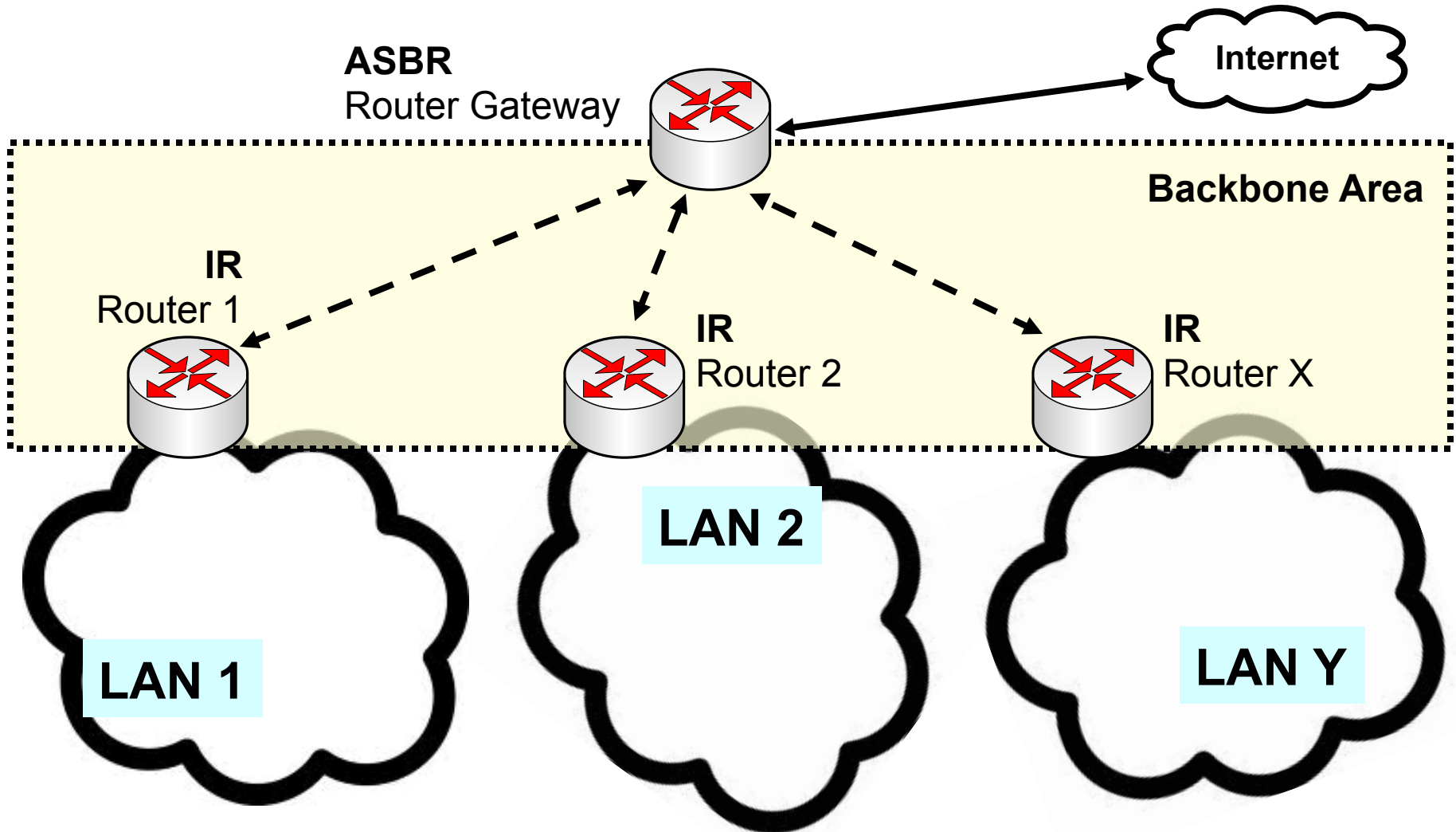

OSPF - Configuration

The image shows the Mikrotik WinBox interface for configuring OSPF. On the left sidebar, the 'Routing' menu is highlighted. The main window displays the 'OSPF' configuration page, where the 'Instances' tab is selected. A table lists the OSPF instances, with 'default' selected and highlighted by a red box. A red arrow points from the 'Instances' tab to the 'default' instance. The 'OSPF Instance <default>' dialog is open, showing the 'General' tab. The 'Redistribute Connected Routes' dropdown is set to 'as type 1' and is highlighted by a red box. Other options include 'Name: default', 'Router ID: 0.0.0.0', and various 'Redistribute' settings for default, static, RIP, BGP, and other OSPF routes. The 'In Filter' is 'ospf-in' and the 'Out Filter' is 'ospf-out'.

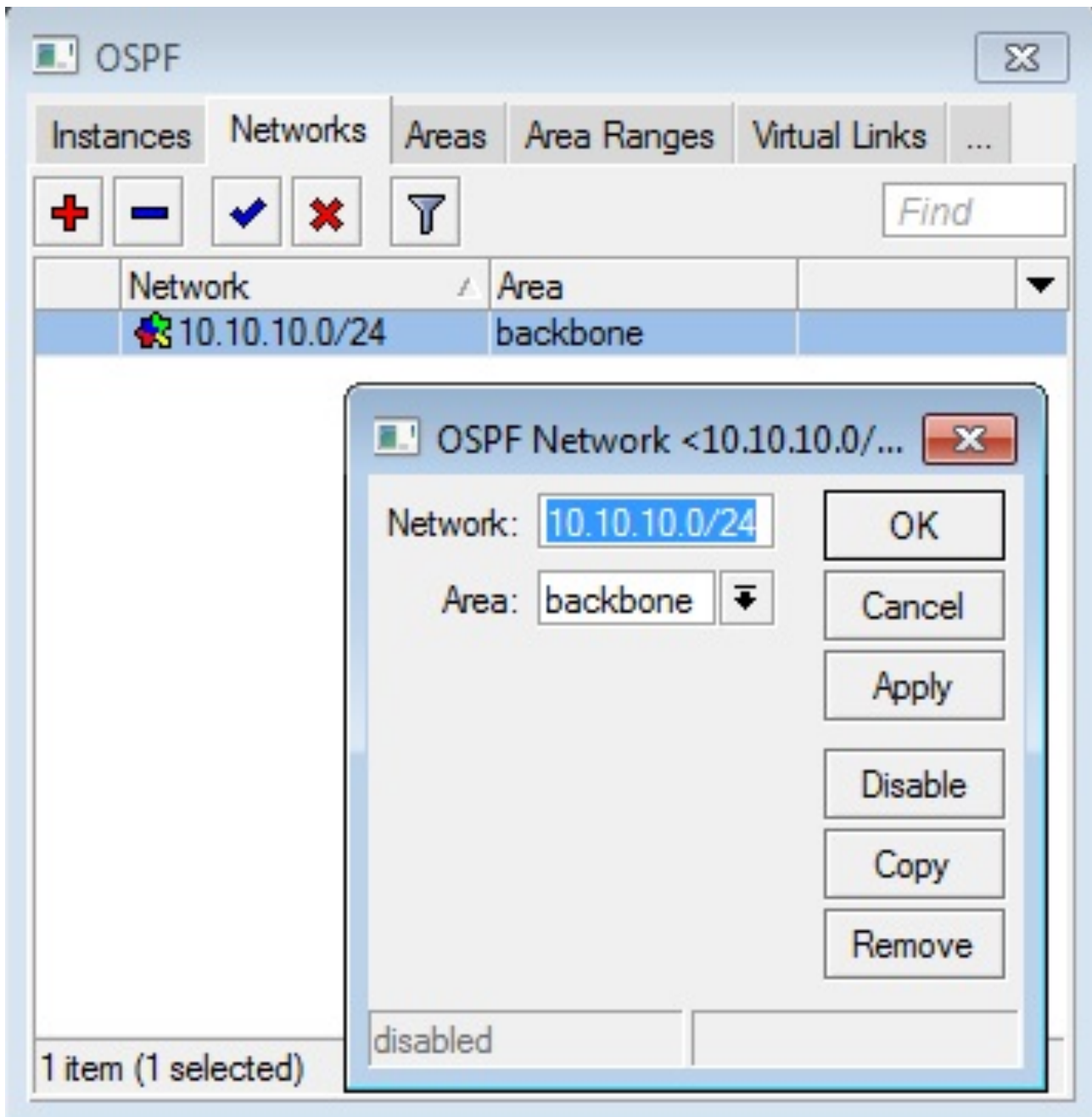



Hotspot



Certified Mikrotik Training Basic Class

Organized by: **Citraweb Nusa Infomedia**

(Mikrotik Certified Training Partner)



HotSpot

- Hotspot System digunakan untuk memberikan layanan akses jaringan (Internet/Intranet) di Public Area dengan media kabel maupun wireless.
- Hotspot menggunakan Autentikasi untuk menjaga Jaringan tetap dapat dijaga walaupun bersifat public.
- Proses Autentikasi menggunakan protocol HTTP/HTTPS yang bisa dilakukan oleh semua web-browser.
- Hotspot System ini merupakan gabungan atau kombinasi dari beberapa fungsi dan fitur RouterOS menjadi sebuah system yang sering disebut 'Plug-n-Play' Access.

HotSpot Network - Example

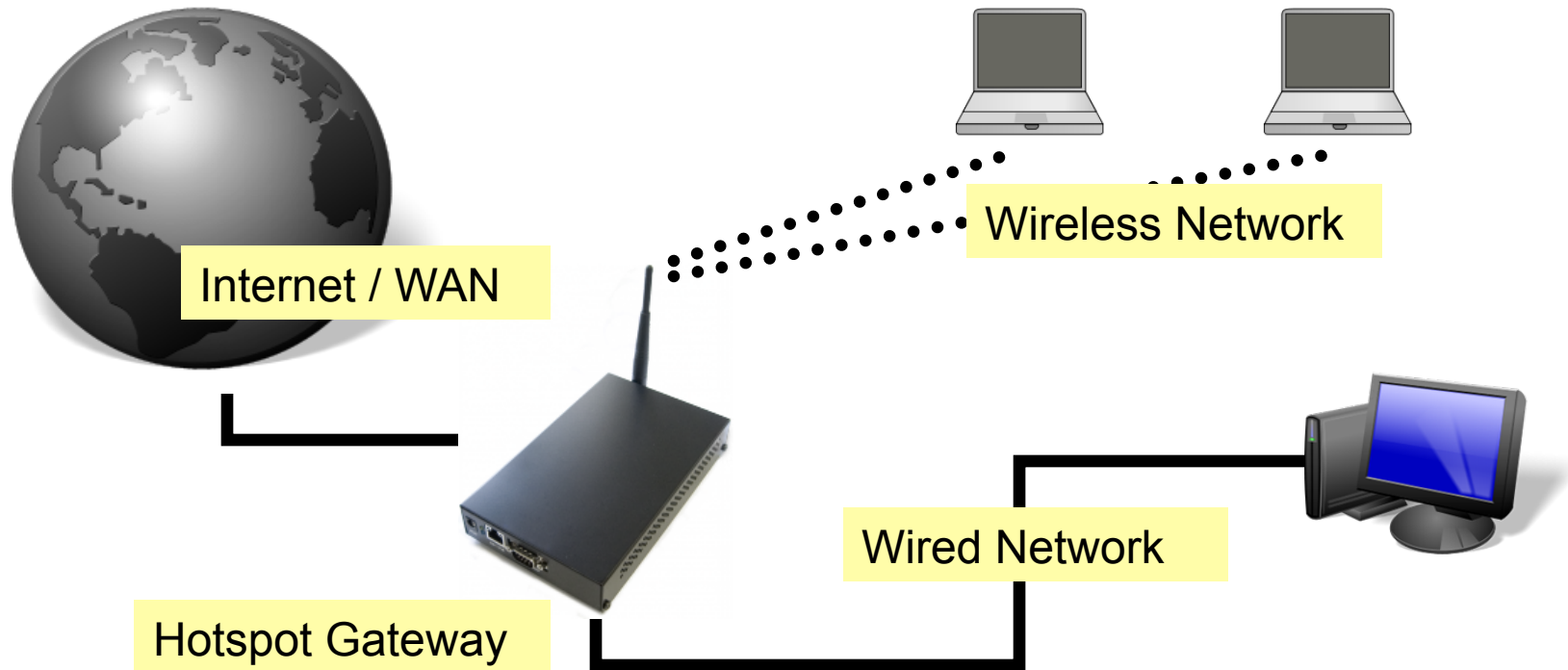

- Hotspot System bisa digunakan pada jaringan Wireless maupun jaringan Kabel bahkan kombinasi dari keduanya.
- Jaringan Hotspot bersifat **Bridge Network**

How does it work ?

- User mencoba membuka halaman web.
- Authentication Check dilakukan oleh router pada Hotspot System.
- Jika belum terautentikasi, router akan mengalihkan ke halaman login.
- User memasukkan informasi login.

Please log on to use the mikrotik hotspot service

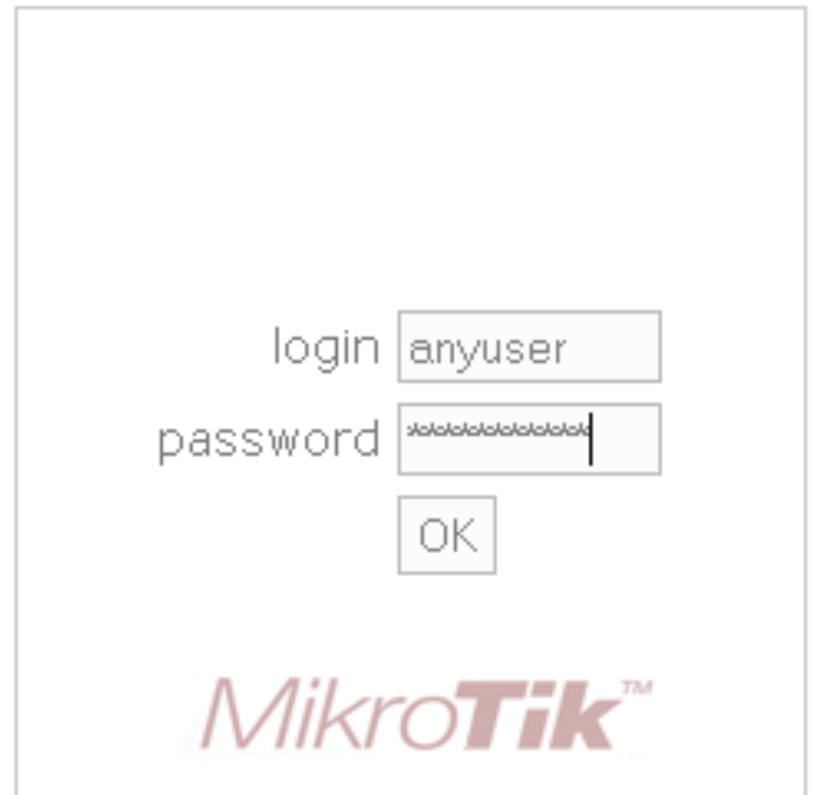

A screenshot of a Mikrotik Hotspot login page. The page has a white background with a light gray border. At the top, it says "Please log on to use the mikrotik hotspot service". Below this, there are three input fields: "login" with the text "anyuser", "password" with a masked password "xoxoxoxoxoxoxoxox", and an "OK" button. At the bottom, the Mikrotik logo is displayed in a stylized font.

Powered by mikrotik routers © 2005 mikrotik

How does it work ?

- Jika informasi login sudah tepat, router akan :
 - Mengautentikasi client di hotspot system.
 - Membuka halaman web yang diminta sebelumnya.
 - Membuka popup halaman status.
- User dapat menggunakan akses jaringan.

Welcome anyuser!

IP address:	10.1.100.1
bytes up/down:	23.1 KiB / 43.5 KiB
connected:	40s
status refresh:	1m

log off



HotSpot features

- Autentikasi User
- Perhitungan
 - Waktu akses
 - Data dikirim atau diterima
- Limitasi Data
 - Berdasarkan data rate (kecepatan akses)
 - Berdasarkan jumlah data
- Limitasi Akses User berdasarkan waktu
- Support RADIUS
- Bypass!



HotSpot setup wizard

- RouterOS sudah menyediakan Wizard untuk melakukan setup Hotspot System.
- Wizard ini berupa menu interaktif yang terdiri dari beberapa pertanyaan mengenai parameter setting hotspot.
- Wizard bisa dipanggil atau dieksekusi menggunakan perintah “***/ip hotspot setup***”
- Jika anda mengalami kegagalan dalam konfigurasi hotspot direkomendasikan reset kembali router dan konfigurasi ulang dari awal.

HotSpot Setup Wizard

- Pada Langkah awal Tentukan interface mana yang akan digunakan untuk menjalankan Hotspot System:
hotspot interface: (ex: ether1,wlan1,bridge1,vlan1)
- Tentukan Alamat IP untuk Interface Hotspot :
Local address of hotspot network: (ex: 10.5.50.1/24)
- Opsi Hotspot Network akan NAT atau Routing :
masquerade hotspot network: yes
- Tentukan IP-Pool untuk jaringan Hotspot :
address pool of hotspot network: 10.5.50.2-10.5.50.254
- Menggunakan SSL-certificate jika ingin menggunakan Login-By HTTPS :
select certificate: none

HotSpot Setup Wizard

- Jika diperlukan SMTP server khusus untuk Server hotspot bisa ditentukan, sehingga Server bisa mengirimkan email (misal email notifikasi). Konfigurasi SMTP server :
Ip address of smtp server: 0.0.0.0 (ex: 159.148.147.194)
- Konfigurasi DNS server yang akan digunakan oleh user Hotspot :
dns servers: 159.148.147.194,159.148.60.20
- Konfigurasi DNS-name dari router Hotspot, Hal ini digunakan jika Router memiliki DNS-Name yang valid (FQDN), Jika tidak ada biarkan kosong.
- Langkah terakhir dari wizard adalah pembuatan sebuah user hotspot :
name of local hotspot user: usrox
password for the user: 12345

HotSpot Setup Wizard (Step 1)

The screenshot displays the Mikrotik WinBox interface. On the left sidebar, the 'Hotspot' menu item is circled in red. A red arrow points from this menu item to the 'Hotspot Setup' dialog box. The dialog box is titled 'Hotspot Setup' and contains the following elements:

- Buttons: Servers, Users, Active, Hosts, IP Bindings, Service Ports, Walled Garden, Cookies
- Buttons: Profiles, Setup (circled in red)
- Buttons: +, -, ✓, ✗
- Buttons: Interface, Address Pool, Profile, Addresses ...
- Text: Select interface to run HotSpot on
- Dropdown menu: HotSpot Interface: ether1
- Buttons: Back, Next, Cancel

HotSpot Setup Wizard (Step 2-5)

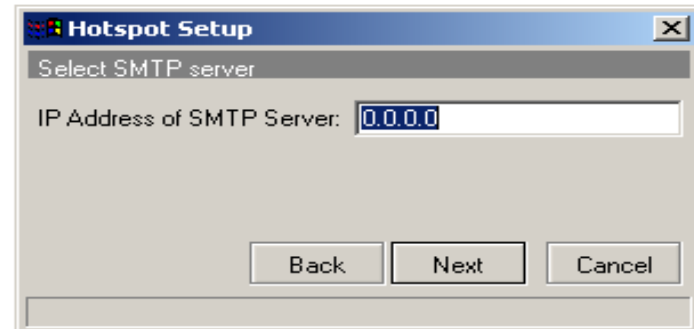
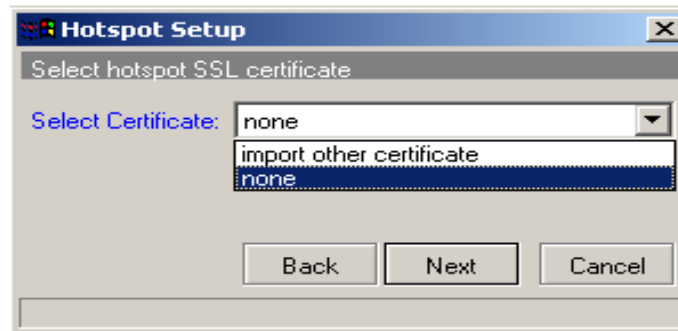
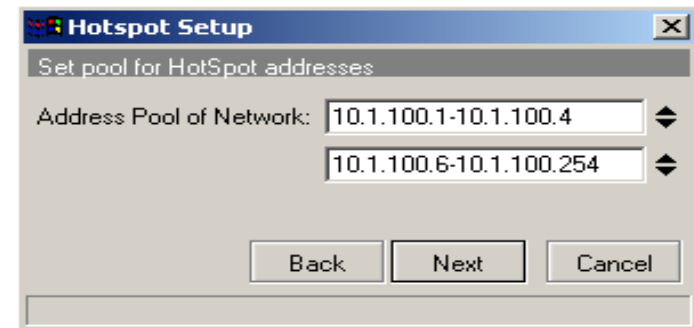
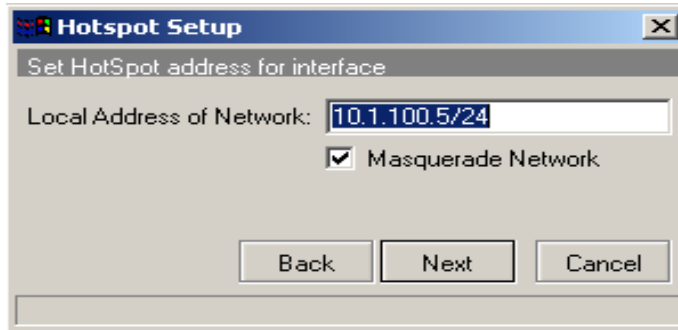

HotSpot setup wizard (step 5-8)

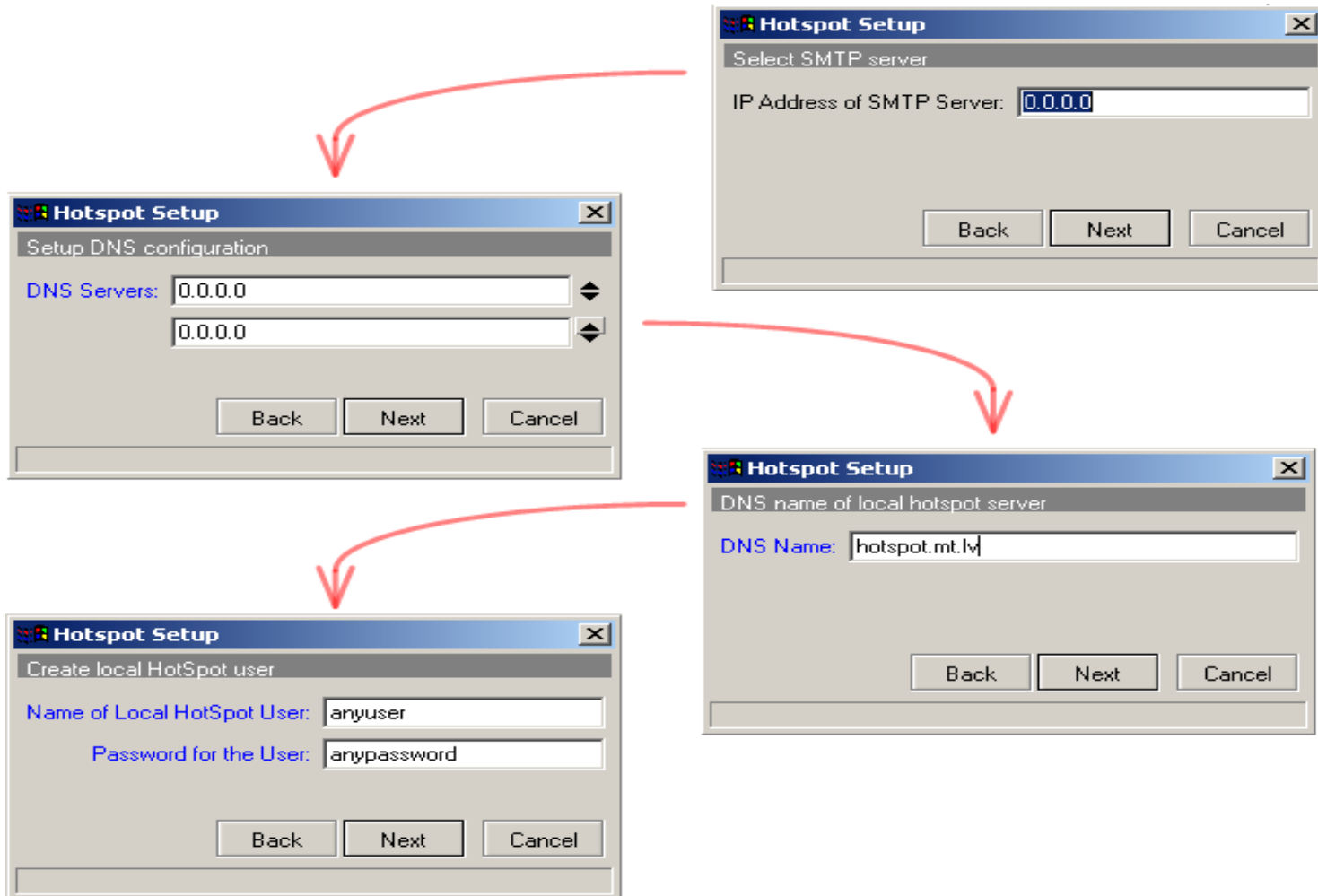

HotSpot Server Profiles

The screenshot displays the Mikrotik WinBox interface for configuring Hotspot Server Profiles. The main window shows a list of profiles:

Name	DNS Name	HTML Directory
* default		hotspot
hsprof1		hotspot

The 'hsprof1' profile is selected. The 'Hotspot Server Profile <hsprof1>' dialog box is open, showing the 'RADIUS' tab. The configuration options are as follows:

- Login By: MAC, Cookie
- HTTP CHAP, HTTPS
- HTTP PAP, Trial
- MAC Auth. Password: [Empty field]
- HTTP Cookie Lifetime: 3d 00:00:00
- SSL Certificate: none
- Split User Domain
- Trial Uptime Limit: 00:30:00
- Trial Uptime Reset: 1d 00:00:00
- Trial User Profile: default

HotSpot Server profiles

- Hotspot Server Profile digunakan untuk menyimpan konfigurasi-konfigurasi umum dari beberapa hotspot server.
- Profile ini digunakan untuk grouping beberapa hotspot server dalam satu router.
- Pada server profile terdapat konfigurasi yang berpengaruh pada user hotspot seperti :
 - **Metode Autentikasi**
- Ada 6 Metode autentikasi yang bisa digunakan di Server-Profile.

Authentication Method

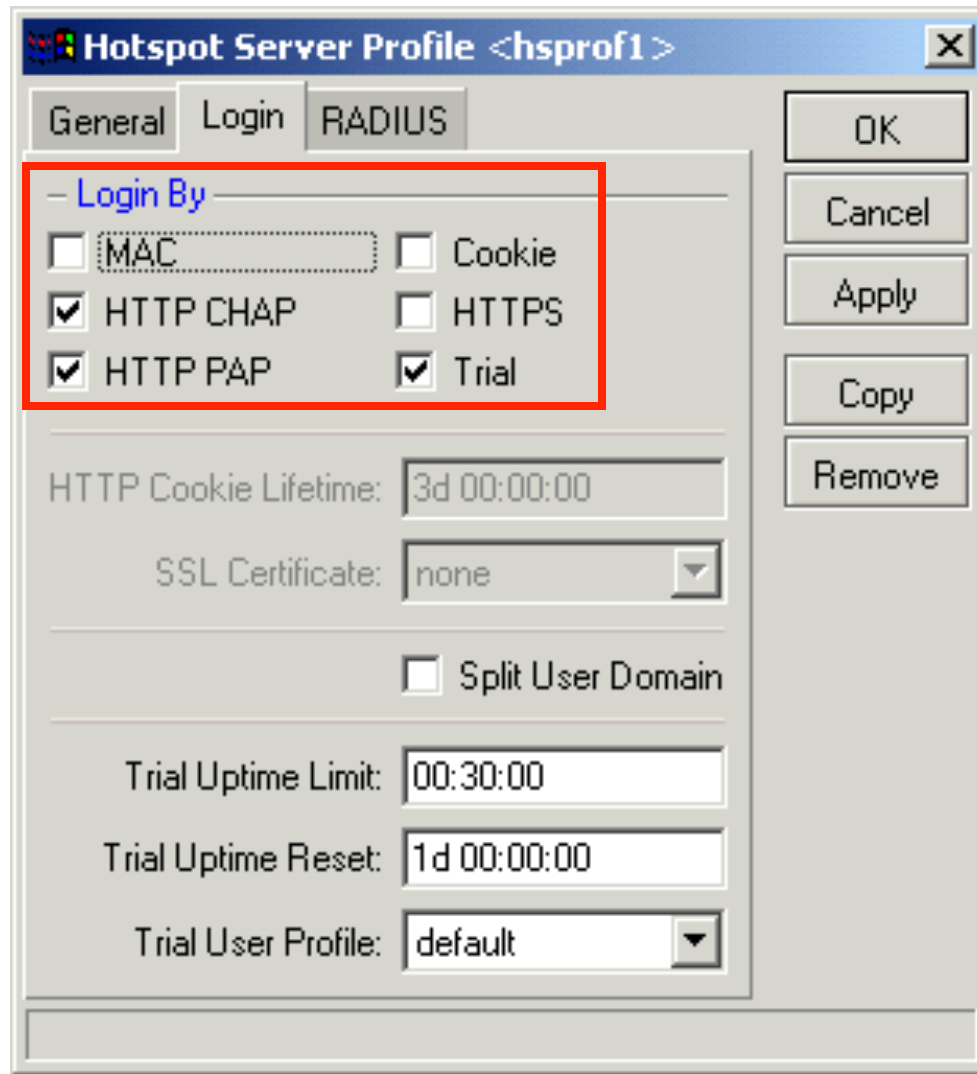

- 6 Metode autentikasi yang berbeda pada server profile.

Hotspot Authentication Methods

- **HTTP-PAP** - metode autentikasi yang paling sederhana, yaitu menampilkan halaman login dan mengirimkan info login berupa plain text.
- **HTTP-CHAP** - metode standard yang mengintegrasikan proses CHAP pada proses login.
- **HTTPS** – menggunakan Enkripsi Protocol SSL untuk Autentikasi.
- **HTTP Cookie** - setelah user berhasil login data cookie akan dikirimkan ke web-browser dan juga disimpan oleh router di 'Active HTTP cookie list' yang akan digunakan untuk autentikasi login selanjutnya.
- **MAC Address** - metode ini akan mengautentikasi user mulai dari user tersebut muncul di 'host-list', dan menggunakan MAC address dari client sebagai username dan password.
- **Trial** - User tidak memerlukan autentikasi pada periode waktu yang sudah ditentukan.



HotSpot User Profiles

- Hotspot User Profile digunakan untuk menyimpan konfigurasi-konfigurasi umum dari User-user hotspot. Profile ini digunakan untuk grouping beberapa User.
- Pada User Profile, mampu melakukan assign pool-ip tertentu ke group user.
- Parameter Time-out juga bisa diaktifkan untuk mencegah monopoli oleh salah satu user.
- Limitasi juga bisa ditentukan di UserProfile
 - Data Rate (Kecepatan Akses)
 - Session Time (Sesi Akses)

User Profiles

Untuk melakukan log-off otomatis bagi user yang tidak ada traffic atau lupa menekan tombol log-off.

Untuk menentukan jumlah user maksimal jika menggunakan "username" yang sama.

Untuk menentukan bandwidth "per-user" yang menggunakan profile yang sama.

Format : **Upload / Download**

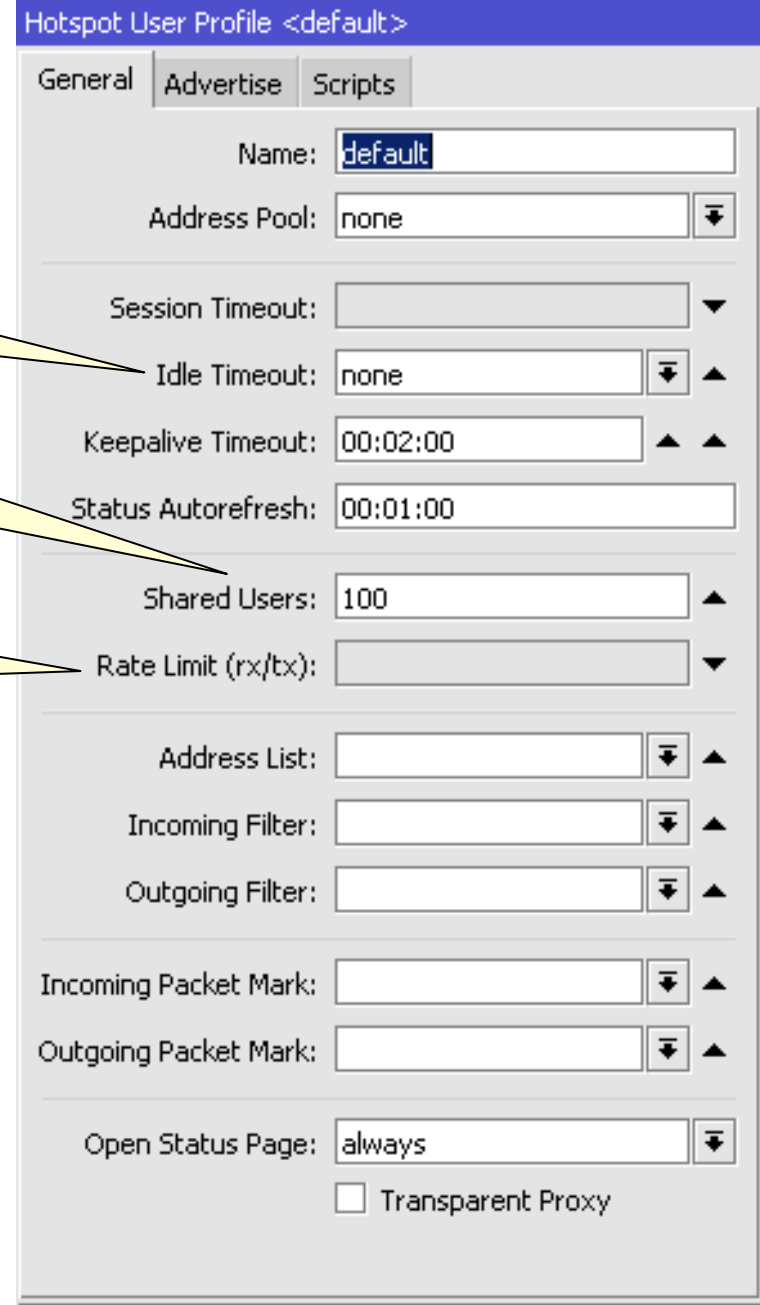

Hotspot User Profile <default>

General | Advertise | Scripts

Name: default

Address Pool: none

Session Timeout: [dropdown]

Idle Timeout: none

Keepalive Timeout: 00:02:00

Status Autorefresh: 00:01:00

Shared Users: 100

Rate Limit (rx/tx): [dropdown]

Address List: [dropdown]

Incoming Filter: [dropdown]

Outgoing Filter: [dropdown]

Incoming Packet Mark: [dropdown]

Outgoing Packet Mark: [dropdown]

Open Status Page: always

Transparent Proxy



HotSpot User

- Halaman dimana parameter username, password dan profile dari user disimpan.
- Beberapa limitasi juga bisa ditentukan di halaman user seperti uptime-limit dan bytes-in/bytes-out. Jika limitasi sudah tercapai maka user tersebut akan expired dan tidak dapat digunakan lagi.
- IP yang spesifik juga bisa ditentukan di halaman ini sehingga user akan mendapat ip yang sama.
- User bisa dibatasi pada MAC-address tertentu.

HotSpot users

The screenshot displays the Mikrotik WinBox interface for configuring Hotspot users. On the left, the navigation menu is visible, with 'Hotspot' selected under the 'Tools' category. The main window shows the 'Hotspot' configuration page, with the 'Users' tab active. A '+' button is highlighted with a red box, indicating the action to add a new user. The 'New Hotspot User' dialog is open, showing the 'General' tab. The 'Name' field is filled with 'user1' and the 'Password' field is empty, both highlighted with red boxes. The 'Server' dropdown is set to 'all'. Other fields like 'Address', 'MAC Address', 'Profile', 'Routes', and 'Email' are also visible but not highlighted.

User Limitation

- **Limit Uptime** batas waktu user dapat menggunakan akses ke Hotspot Network.
- **Limit-bytes-in**, **Limit-bytes-out** dan **Limit-bytes-total** batas quota transfer data yang bisa dilakukan oleh user.

The screenshot shows the 'New Hotspot User' configuration window with the 'Limits' tab selected. The 'Limit Uptime' field is set to '01:00:00'. The 'Limit Bytes In' and 'Limit Bytes Out' fields are empty. The 'Limit Bytes Total' field is set to '20000000000'. Each field has a small up or down arrow icon to its right.

Field	Value
Limit Uptime	01:00:00
Limit Bytes In	
Limit Bytes Out	
Limit Bytes Total	20000000000

Bypass! - IP bindings

- One-to-one NAT bisa dikonfigurasi secara static berdasarkan :
 - Original IP Host
 - Original MAC Address
- Bypass host terhadap Hotspot Authentication bisa dilakukan menggunakan IP-Bindings.
- Block Akses dari host tertentu (Berdasarkan Original MAC-address atau Original IP-Address) juga bisa dilakukan menggunakan IP-Bindings.

HotSpot IP bindings

The screenshot shows the Mikrotik HotSpot configuration interface. The 'IP Bindings' tab is selected. A 'New Hotspot IP Binding' dialog box is open, showing the following fields:

- MAC Address: AA:BB:CC:DD:EE:FF
- Address: 0.0.0.0
- To Address: (empty)
- Server: all
- Type: regular (dropdown menu is open, showing options: regular, blocked, bypassed, regular)

The dialog box also has buttons for OK, Cancel, Apply, Disable, Comment, Copy, and Remove. The 'enabled' checkbox is checked. The main table below the dialog is empty, showing 0 items.

● ● ● | Bypass - WalledGarden

- **WalledGarden** adalah sebuah system yang memungkinkan untuk user yang belum terautentikasi menggunakan (Bypass!) beberapa resource jaringan tertentu tetapi tetap memerlukan autentikasi jika ingin menggunakan resource yang lain.
- **IP-WalledGarden** hampir sama seperti WalledGarden tetapi mampu melakukan bypass terhadap resource yang lebih spesifik pada protocol dan port tertentu.
- Biasanya digunakan untuk melakukan bypass terhadap server local yang tidak memerlukan autentikasi.

HTTP-level WalledGarden

Hotspot

Server Profiles Users User Profiles Active Hosts IP Bindings Service Ports **Walled Garden**

+ - ✓ ✗ [icon] [icon]

Action	Server	Method	Dst. Host	Dst. Port
allow				

Walled Garden Entry <*mikrotik.co.id>

Action: allow deny

Server: [dropdown]

Src. Address: [dropdown]

Dst. Address: [input]

Method: [dropdown]

Dst. Host: *mikrotik.co.id [dropdown]

Dst. Port: [dropdown]

Path: [dropdown]

OK Cancel Apply Disable Comment Copy Remove

1 item enabled

IP-WalledGarden

The screenshot shows the Mikrotik WinBox interface for configuring the Walled Garden. The main window is titled "Hotspot" and has several tabs: "Server Profiles", "Users", "User Profiles", "Active", "Hosts", "IP Bindings", "Service Ports", "Walled Garden", and "Walled Garden IP List". The "Walled Garden IP List" tab is selected and highlighted with a red box. Below the tabs is a toolbar with several icons, including a red-bordered "+" icon. Below the toolbar is a table with columns: "Action", "Server", "Src. Address", "Protocol", and "Dst. Port". The table is currently empty, showing "0 items".

A "New Walled Garden IP Entry" dialog box is open, showing the following configuration options:

- Action: accept drop reject
- Server: [Dropdown menu]
- Src. Address: [Text input]
- Dst. Address: [Text input]
- Protocol: tcp [Dropdown menu]
- Dst. Port: 20-21 [Text input]
- Dst. Host: [Text input]

Buttons on the right side of the dialog include: OK, Cancel, Apply, Disable, Comment, Copy, and Remove. The dialog also has a status bar at the bottom that says "enabled".

Advertisement

- Sama seperti yang digunakan pada fasilitas WalledGarden, Advertisement juga menggunakan ProxyEngine di Hotspot System untuk menampilkan popup halaman web (iklan) di web-browser para user yang sudah terautentikasi.
- Halaman Advertisement dimunculkan berdasarkan periode waktu yang sudah ditentukan, dan akses akan dihentikan jika pop-up halaman advertisement diblock (pop-up blocker aktif), dan akan disambungkan kembali jika halaman Advertisement sudah dimunculkan.

Advertisement

- Jika sudah waktunya untuk memunculkan advertisement, server akan memanggil halaman status dan meriderect halaman status tersebut ke halaman web iklan yang sudah ditentukan.

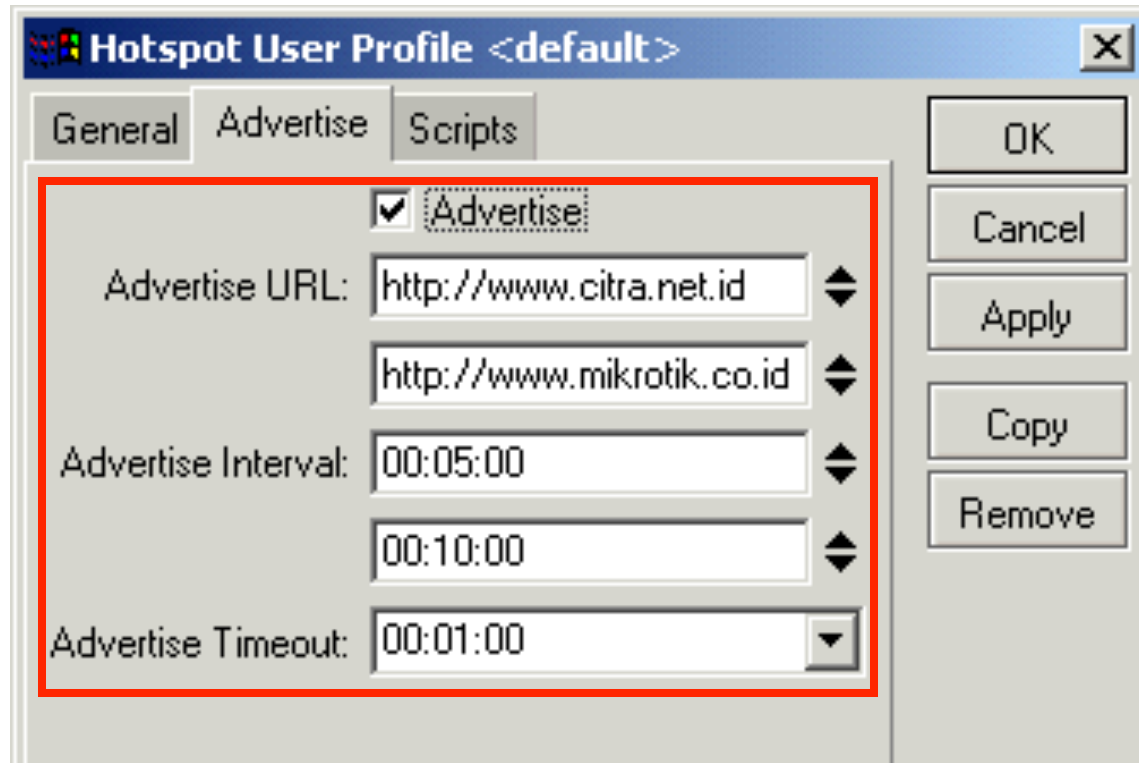



VPN Basic



Certified Mikrotik Training Basic Class

Organized by: Citraweb Nusa Infomedia

(Mikrotik Certified Training Partner)



VPN (Virtual Private Networks)

- Virtual Private Network (VPN) adalah sebuah jaringan komputer dimana koneksi antar nodenya **memanfaatkan jaringan public** (Internet / WAN) karena mungkin dalam kondisi atau kasus tertentu tidak memungkinkan untuk membangun infrastruktur jaringan sendiri.
- **Interkoneksi** antar node seperti memiliki jaringan yang **independen** yang sebenarnya dibuatkan koneksi atau jalur khusus melewati jaringan public.
- Pada implementasinya biasanya digunakan untuk membuat **komunikasi yang bersifat secure** melalui jaringan Internet, tetapi VPN tidak harus menggunakan standard keamanan yang baku seperti Autentikasi dan enkripsi.
- Salah satu contohnya adalah Penggunaan VPN untuk akses network dengan tingkat security yang tinggi di system reservasi ticket.

VPN Networks

- Virtual Private Network. Jaringan Data yang bersifat independen yang memanfaatkan infrastruktur jaringan public.

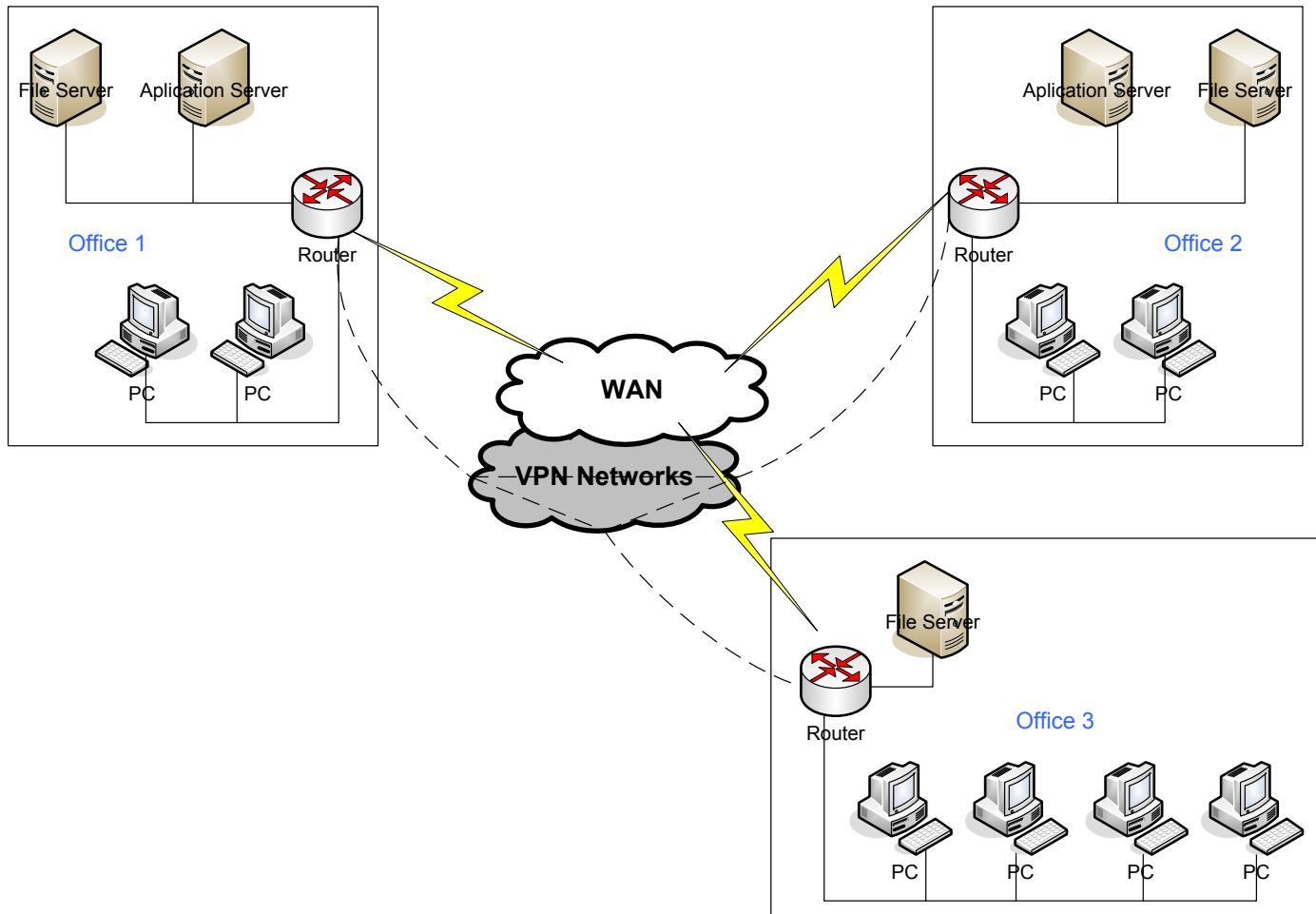



VPN Type

- VPN bisa diimplementasikan di berbagai type network :
- Routed Network :
 - VPN yang dilakukan di network yang sudah melewati multi hop router atau melewati internet. Contohnya adalah menggunakan **PPTP**.
- Bridge Network :
 - VPN yang diimplementasikan di network yang masih satu switch (satu network bridge). Contohnya adalah menggunakan **PPPoE**.



Point to Point Tunnel Protocol (PPTP)

- Penggunaan PPTP Tunnel:
 - Koneksi antar router over Internet yang bersifat secure.
 - Untuk menghubungkan jaringan local over WAN.
 - Untuk digunakan sebagai mobile client atau remote client yang ingin melakukan akses ke network local (Intranet) sebuah perusahaan.
- Sebuah koneksi PPTP terdiri dari Server dan Client.
 - Mikrotik RouterOS bisa berfungsi sebagai PPTP server maupun PPTP Client atau gabungan dari keduanya.
- Koneksi PPTP menggunakan TCP port 1723 dan IP protocol 47/GRE.
- Fungsi PPTP clients sudah tersedia atau termasuk dalam sebagian besar Sistem Operasi.

PPTP Client Configuration

The screenshot displays the Mikrotik WinBox interface for configuring a PPTP Client. The 'Interface List' window is open, showing a list of interface types. A red circle highlights the '+' button, and an arrow points to the 'PPTP Client' option in the list. Another red circle highlights the 'PPTP Client' option in the list, and an arrow points to the 'New Interface' dialog box. The 'New Interface' dialog box is open, showing the 'General' tab. The 'Name' field is set to 'pptp-out1', and the 'Type' is set to 'PPTP out'. The 'Server Address' field is set to '0.0.0.0'. The 'Profile' dropdown menu is set to 'default-encryption'. The 'Add Default Route' checkbox is unchecked. The 'Allow' section has checkboxes for 'pap', 'mschap1', 'chap', and 'mschap2', all of which are checked. The 'Status' field is set to 'running'.

Interface List

Interface Ethernet EoIP Tunnel IP Tunnel VLAN VRRP Bonding

+ - ✓ ✗ [Icons] Find

EoIP Tunnel
IP Tunnel
VLAN
VRRP
Bonding
Bridge
VPLS
PPP Server
PPP Client
PPTP Server
PPTP Client
L2TP Server
L2TP Client
OVPN Server
OVPN Client
PPPoE Server
PPPoE Client
ISDN Server
ISDN Client

Type Tx Rx Tx Pac... Rx Pac...
Ethernet
Ethernet
Ethernet
Ethernet
Ethernet
Ethernet

New Interface

General Dial Out Status Traffic

Name: pptp-out1
Type: PPTP out
Max MTU: 1460
Max MRU: 1460

Server Address: 0.0.0.0

User:
Password:
Profile: default-encryption

Add Default Route

— Allow —
 pap chap
 mschap1 mschap2

disabled running disabled running

PPTP Client Configuration

- **Server Address** – Parameter server PPTP yang akan di dial
- **User** – Parameter username
- **Password** – Parameter password
- **Profile** – Parameter optional untuk mengaktifkan enkripsi pada link pptp atau tidak.

[LAB-1] PPTP Tunnels - Client

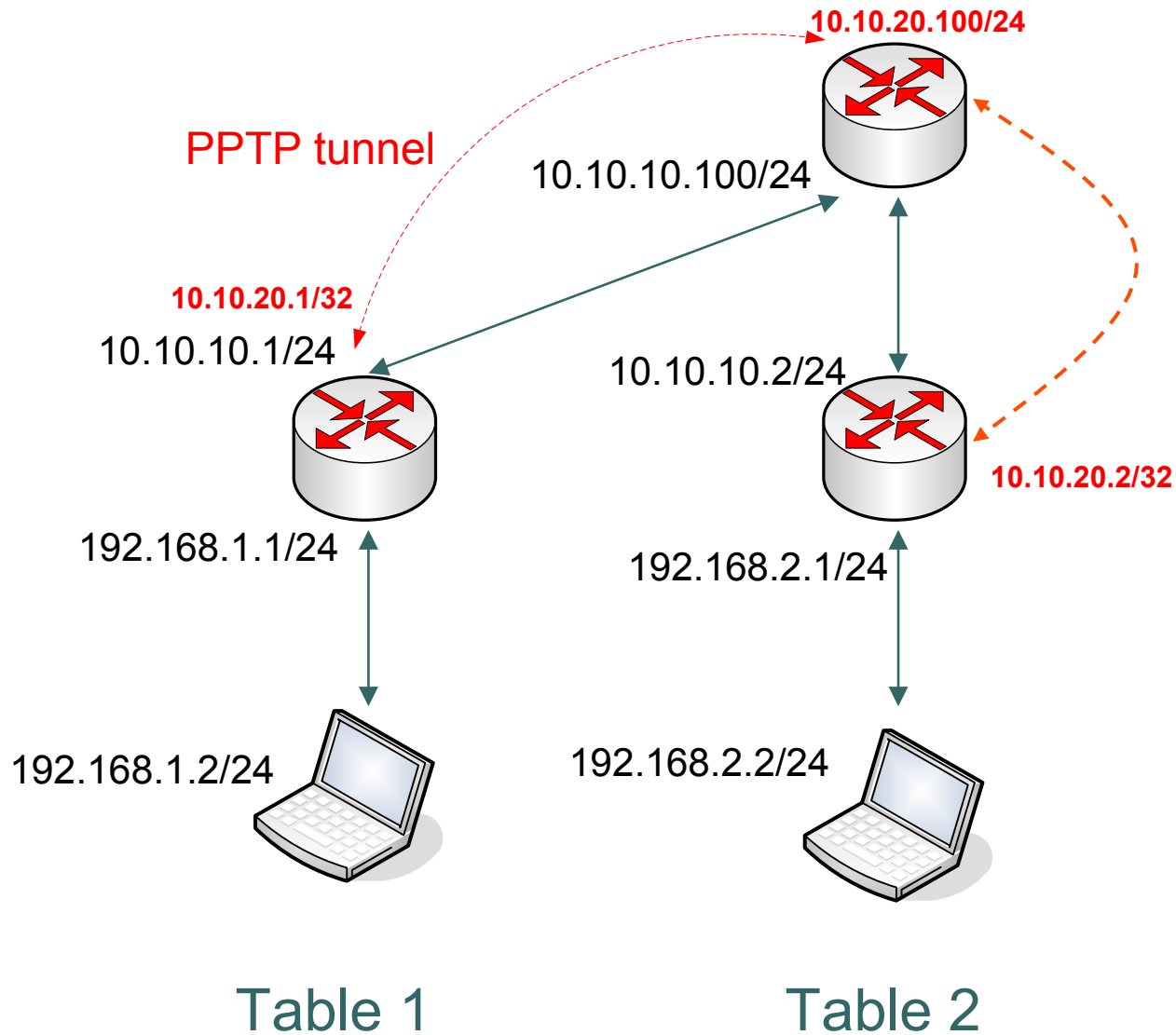

Table 1

Table 2

[LAB-1] PPTP Tunnels - Client

The screenshot displays the Mikrotik WinBox interface. The 'Interface List' window is open, showing a list of interface types. The 'PPTP Client' option is selected and circled in red. A red box highlights the 'Add' (+) button in the toolbar. The 'New Interface' window is also open, showing the configuration for a PPTP Client. The 'Connect To' field is set to '10.10.10.100', the 'User' is 'user1', and the 'Password' is masked with '*****'. The 'Profile' is set to 'default-encryption'. The 'Allow' section has checkboxes for 'pap', 'chap', 'mschap1', and 'mschap2', all of which are checked. The 'Status' field at the bottom is set to 'disabled'.

Interface	Type
EoIP Tunnel	Ethernet
IP Tunnel	Ethernet
VLAN	Ethernet
VRRP	Ethernet
Bonding	Ethernet
Bridge	Ethernet
VPLS	Ethernet
PPP Server	
PPP Client	
PPTP Server	
PPTP Client	
L2TP Server	
L2TP Client	
OVPN Server	
OVPN Client	
PPPoE Server	
PPPoE Client	
ISDN Server	
ISDN Client	

New Interface Configuration:

- Connect To: 10.10.10.100
- User: user1
- Password: *****
- Profile: default-encryption
- Add Default Route
- Allow:
 - pap
 - chap
 - mschap1
 - mschap2
- Status: disabled

[LAB-1] PPTP Tunnels - Client

o Membuat PPTP-Client :

- “Username” dan “Password” disesuaikan dari konfigurasi server.
- “Connect-to” adalah parameter Alamat IP dari PPTP-Server.
- “Add-Default-Route” adalah parameter jika akan menggunakan koneksi PPTP sebagai gateway utama.

o Membuat PPTP-Client Interface :

```
•/interface pptp-client add name=pptp-out1  
connect-to=10.10.10.100 user=user1 password=user1
```

PPTP Server Configuration

The screenshot shows the Mikrotik WinBox interface for configuring PPP services. The 'PPTP Server' button is highlighted with a red circle. An arrow points from this button to the 'PPTP Server' configuration dialog box. In the dialog, the 'Enabled' checkbox is checked and highlighted with a red dotted border. Other settings include Max MTU: 1460, Max MRU: 1460, MRRU: (empty), Keepalive Timeout: 30, and Default Profile: default-encryption. Under the 'Authentication' section, 'pap' and 'chap' are unchecked, while 'mschap1' and 'mschap2' are checked.

Name	Type	L2 MTU	Tx	Rx	Tx Pac...	Rx Pac...
R	pptp-out1	PPTP Client				

PPTP Server

Enabled

Max MTU: 1460

Max MRU: 1460

MRRU: [] ▼

Keepalive Timeout: 30 ▲

Default Profile: default-encryption ▼

— Authentication —

pap chap

mschap1 mschap2

OK
Cancel
Apply

PPTP Server Configuration

- **Service** PPTP server bisa diaktifkan pada PPP configuration
- **Default Profile** digunakan untuk menentukan group dan memberikan konfigurasi dasar seperti ip address, penggunaan enkripsi dan juga limitasi user
- Default Profile digunakan untuk user-user yang tidak terdapat di database local router contohnya jika autentikasi user menggunakan RADIUS.

[LAB-2] PPTP Tunnels - Server

Aktifkan PPTP server, pastikan menggunakan profile “default-encryption” supaya link VPN terenkripsi.

The screenshot shows the Mikrotik WinBox interface for configuring PPTP servers. The main window has tabs for 'Interface', 'PPPoE Servers', 'Secrets', 'Profiles', and 'Active Connections'. The 'PPTP Server' button is highlighted with a red box. Below it, a table lists the server configuration:

Name	Type	L2 MTU	Tx	Rx	Tx Pac...	Rx Pac...
R	pptp-out1	PPTP Client				

The 'PPTP Server' configuration dialog box is open, showing the following settings:

- Enabled
- Max MTU: 1460
- Max MRU: 1460
- MRRU: [dropdown]
- Keepalive Timeout: 30
- Default Profile: default-encryption
- Authentication: pap, mschap1, chap, mschap2

Buttons for 'OK', 'Cancel', and 'Apply' are visible on the right side of the dialog box.

[LAB-2] PPTP Tunnels - Server

Interface PPPoE Servers **Secrets** Profiles Active Connections

+ ←

Name	Password	Service
------	----------	---------

New PPP Secret

Name: pptp-user1

Password: ****

Service: any

Local Address: 10.20.30.40

Remote Address: 192.168.192.168

Remote IPv6 Prefix:

0 items

Buat User PPTP di "PPP-Secrets" pastikan isikan "Local Address" dan "Remote Address".



PPP - Secret

- PPP – Secret adalah data user untuk Service VPN (PPTP, PPPoE, OpenVPN dll) yang ada di local database router, semua konfigurasi user seperti username, password, alokasi ip address, profile dan limitasi bisa dilakukan di sini.
- Ada dua pilihan melakukan assign ip ke user yaitu menggunakan setting di secret (fix ip) atau menggunakan profile (pool ip).
- VPN User juga bisa menggunakan database user external yaitu menggunakan RADIUS seperti UserManager atau FreeRadius.

● ● ● | PPPoE - Point to Point Protocol over Ethernet

- Penggunaan PPPoE Tunnel:
 - Koneksi antar Client dan Router yang bersifat secure.
 - Untuk digunakan sebagai koneksi internet bersifat secure di jaringan local (LAN).
- Sebuah koneksi PPPoE terdiri dari Server dan Client.
 - Mikrotik RouterOS bisa berfungsi sebagai PPPoE server maupun PPPoE Client atau gabungan dari keduanya.
- Koneksi PPPoE menggunakan Ethernet frame sebagai protocol transportnya.
- Fungsi PPPoE clients sudah tersedia atau termasuk dalam sebagian besar Sistem Operasi.

PPPoE Server

The image shows the Mikrotik WinBox interface for configuring a PPPoE server. The left pane displays the 'PPP' menu with 'PPPoE Servers' selected. The right pane shows the 'New PPPoE Service' configuration form.

Left Pane (PPP):

- Interface
- PPPoE Servers**
- Secrets
- Profiles
- Active

Right Pane (New PPPoE Service):

- Service Name:
- Interface:
- Max MTU:
- Max MRU:
- MRRU:
- Keepalive Timeout:
- Default Profile:
- One Session Per Host
- Max Sessions:

Authentication:

- pap
- chap
- mschap1
- mschap2



Firewall



Certified Mikrotik Training Basic Class

Organized by: **Citraweb Nusa Infomedia**

(Mikrotik Certified Training Partner)

Firewall ?

- Firewall diposisikan antara jaringan lokal dan jaringan publik, bertujuan melindungi komputer dari serangan, dan secara efektif mengontrol koneksi data menuju, dari, dan melalui router.

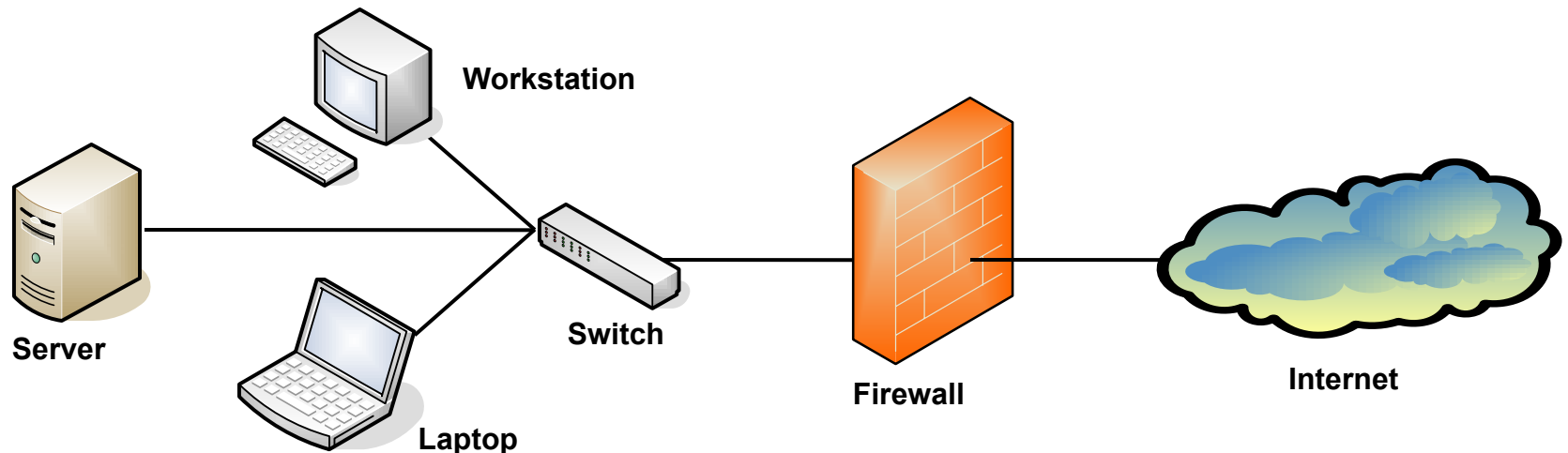



Mikrotik Firewall - Features

- Rules
- NAT (source-nat and destination-nat)
- Mangle
- Address List
- Layer 7 Protocol (baru di versi 3)
- Service Ports
- Connections
 - For monitoring only

Traffic Flow (Aliran Data)

- Setiap paket data memiliki asal (source) dan tujuan (destination).
- Traffic flow bisa dibedakan menjadi 3 kategori, dilihat dari sudut pandang router.
 - **Dari Luar router menuju ke luar router lagi**
 - Contoh : traffic client browsing ke internet
 - **Dari luar router menuju ke dalam router itu sendiri (Local process).**
 - Contoh : traffic winbox ke router
 - **Dari dalam router (local process) menuju ke luar router.**
 - Contoh : traffic ping dari new terminal winbox

Simple Packet Flow

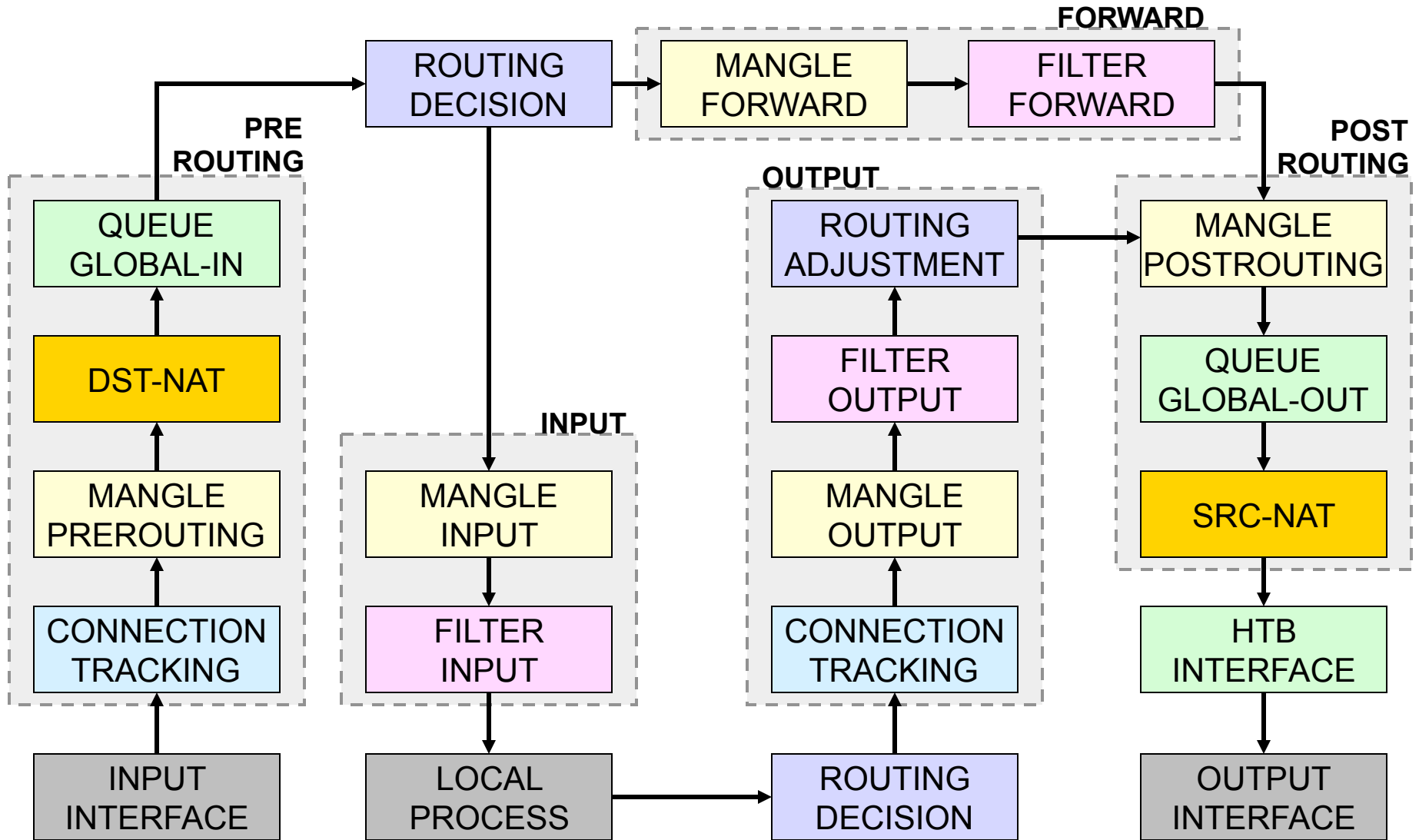

Posisi Chain / Parent

From	To	Mangle	Firewall	Queue
Outside	Router/ Local Process	Prerouting		Global-In
		Input	Input	Global-Total
Router/ Local Process	Outside	Output	Output	Global-Out
		Postrouting		Global-Total
				Interface
Outside	Outside	Prerouting		Global-In
		Forward	Forward	Global-Out
		Postrouting		Global-Total
				Interface

● ● ● | Firewall Filters – Blocking Rules

- Adalah cara untuk memfilter paket, dilakukan untuk meningkatkan keamanan jaringan, dan mengatur flow data dari, ke client, ataupun router
- Pembacaan rule filter dilakukan dari atas ke bawah secara berurutan. Jika melewati rule yang kriterianya sesuai akan dilakukan action yang ditentukan, jika tidak sesuai, akan dianalisa ke baris selanjutnya.

Chain pada Filter

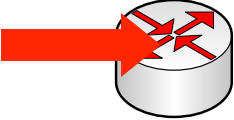
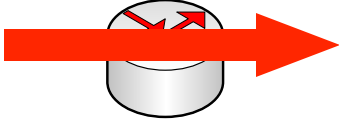
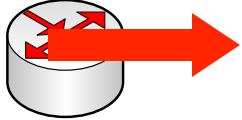
			
Prerouting	not implemented	not implemented	not implemented
Input	yes	no	no
Forward	no	yes	no
Output	no	no	yes
Postrouting	not implemented	not implemented	not implemented



Action Filter

- **accept** – paket diterima dan tidak melanjutkan membaca baris berikutnya
- **drop** – menolak paket secara diam-diam (tidak mengirimkan pesan penolakan ICMP)
- **reject** – menolak paket dan mengirimkan pesan penolakan ICMP
- **tarbit** – menolak, tetapi tetap menjaga TCP connections yang masuk (membalas dengan SYN/ACK untuk paket TCP SYN yang masuk)
- **log** – menambahkan informasi paket data ke log

Filter Rules

The screenshot displays the Mikrotik WinBox interface. The top bar shows the user 'admin@00:0C:42:1B:5C:C1 (MikroTik)' and the device 'WinBox v3.2 on RB500R5 (mipsle)'. The left sidebar contains a tree view with categories like Interfaces, Wireless, Bridge, PPP, IP, Routing, Ports, Queues, Drivers, System, Files, Log, SNMP, and Users. The 'IP' category is expanded, and the 'Firewall' option is highlighted with a red circle. A red arrow points from this 'Firewall' option to the 'New Firewall Rule' dialog box. In the main window, the 'Firewall' tab is active, and the 'Filter Rules' sub-tab is selected, also circled in red. A red circle highlights the '+' icon in the toolbar. The 'New Firewall Rule' dialog box is open, showing the 'General' tab with fields for Chain (set to 'forward'), Src. Address, Dst. Address, Protocol, Src. Port, Dst. Port, Any. Port, P2P, and In. Interface. On the right side of the dialog, there are buttons for OK, Cancel, Apply, Disable, Comment, Copy, Remove, Reset Counters, and Reset All Counters.

RouterOS v5 Services

	PORT	PROTOCOL	DESCRIPTION
1	20	tcp	FTP
2	21	tcp	FTP
3	22	tcp	SSH, SFTP
4	23	tcp	Telnet
5	53	tcp	DNS
6	80	tcp	HTTP
7	179	tcp	BGP
8	443	tcp	SHTTP (Hotspot)
9	646	tcp	LDP (MPLS)
10	1080	tcp	SoCKS (Hotspot)
11	1723	tcp	PPTP
12	1968	tcp	MME
13	2000	tcp	Bandwidth Server
14	2210	tcp	Dude Server
15	2211	tcp	Dude Server
16	2828	tcp	uPnP
17	3128	tcp	Web Proxy
18	8291	tcp	Winbox
19	8728	tcp	API
20	---	/1	ICMP
21	---	/2	IGMP (Multicast)
22	---	/4	IPIP

	PORT	PROTOCOL	DESCRIPTION
23	53	udp	DNS
24	123	udp	NTP
25	161	udp	SNMP
26	500	udp	IPSec
27	520	udp	RIP
28	521	udp	RIP
29	646	udp	LDP (MPLS)
30	1698	udp	RSVP (MPLS)
31	1699	udp	RSVP (MPLS)
32	1701	udp	L2TP
33	1812	udp	User-Manager
34	1813	udp	User-Manager
35	1900	udp	uPnP
36	1966	udp	MME
37	5678	udp	Neighbor Discovery
38	---	/46	RSVP (MPLS)
39	---	/47	PPRP, EoIP
40	---	/50	IPSec
41	---	/51	IPSec
42	---	/89	OSPF
43	---	/103	PIM (Multicast)
44	---	/112	VRRP



Connection State

- Setiap paket data yang lewat memiliki status:
 - **Invalid** – paket tidak dimiliki oleh koneksi apapun, tidak berguna
 - **New** – paket yang merupakan pembuka sebuah koneksi/paket pertama dari sebuah koneksi
 - **Established** – merupakan paket kelanjutan dari paket dengan status new.
 - **Related** – paket pembuka sebuah koneksi baru, tetapi masih berhubungan dengan koneksi sebelumnya.

Connection State

Firewall

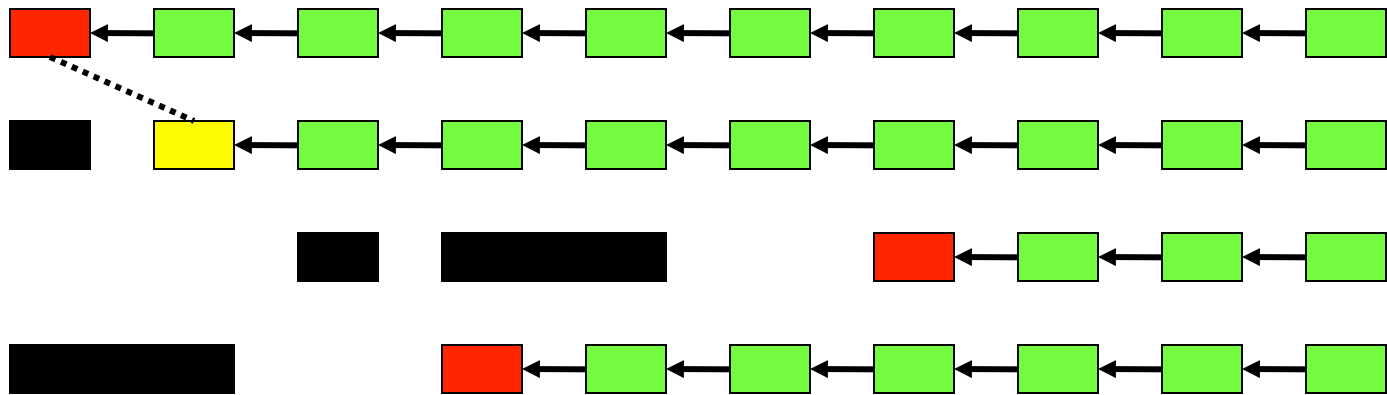

New



Established



Related



Invalid

[LAB-2] Simple Blocking

- Blok semua invalid connection ke router
- Accept koneksi related dan established
- Blok koneksi winbox ke router yang masuk melalui interface public (wlan)
- Blok koneksi dari laptop ke ip tertentu, contoh: 10.10.10.100

Blok Invalid Connection

New Firewall Rule

General Advanced Extra Action Statistics

Chain: input

Src. Address:

Dst. Address:

Protocol:

Src. Port:

Dst. Port:

Any. Port:

P2P:

In. Interface:

Out. Interface:

Packet Mark:

Connection Mark:

Routing Mark:

Connection Type:

Connection State: invalid

disabled

OK
Cancel
Apply
Disable
Comment
Copy
Remove
Reset Counters
Reset All Counters

New Firewall Rule

General Advanced Extra Action Statistics

Action: drop

disabled

OK
Cancel
Apply
Disable
Comment
Copy
Remove
Reset Counters
Reset All Counters

Blok Koneksi Winbox ke Router dari interface publik (wlan)

New Firewall Rule

General | Advanced | Extra | Action | Statistics

Chain: input

Src. Address: []

Dst. Address: []

Protocol: 6 (tcp)

Src. Port: []

Dst. Port: 8291

Any. Port: []

P2P: []

In. Interface: wlan1

Out. Interface: []

Packet Mark: []

Connection Mark: []

Routing Mark: []

Connection Type: []

Connection State: []

disabled

OK
Cancel
Apply
Disable
Comment
Copy
Remove
Reset Counters
Reset All Counters

New Firewall Rule

General | Advanced | Extra | Action | Statistics

Action: drop

disabled

OK
Cancel
Apply
Disable
Comment
Copy
Remove
Reset Counters
Reset All Counters

Blok Nude Site

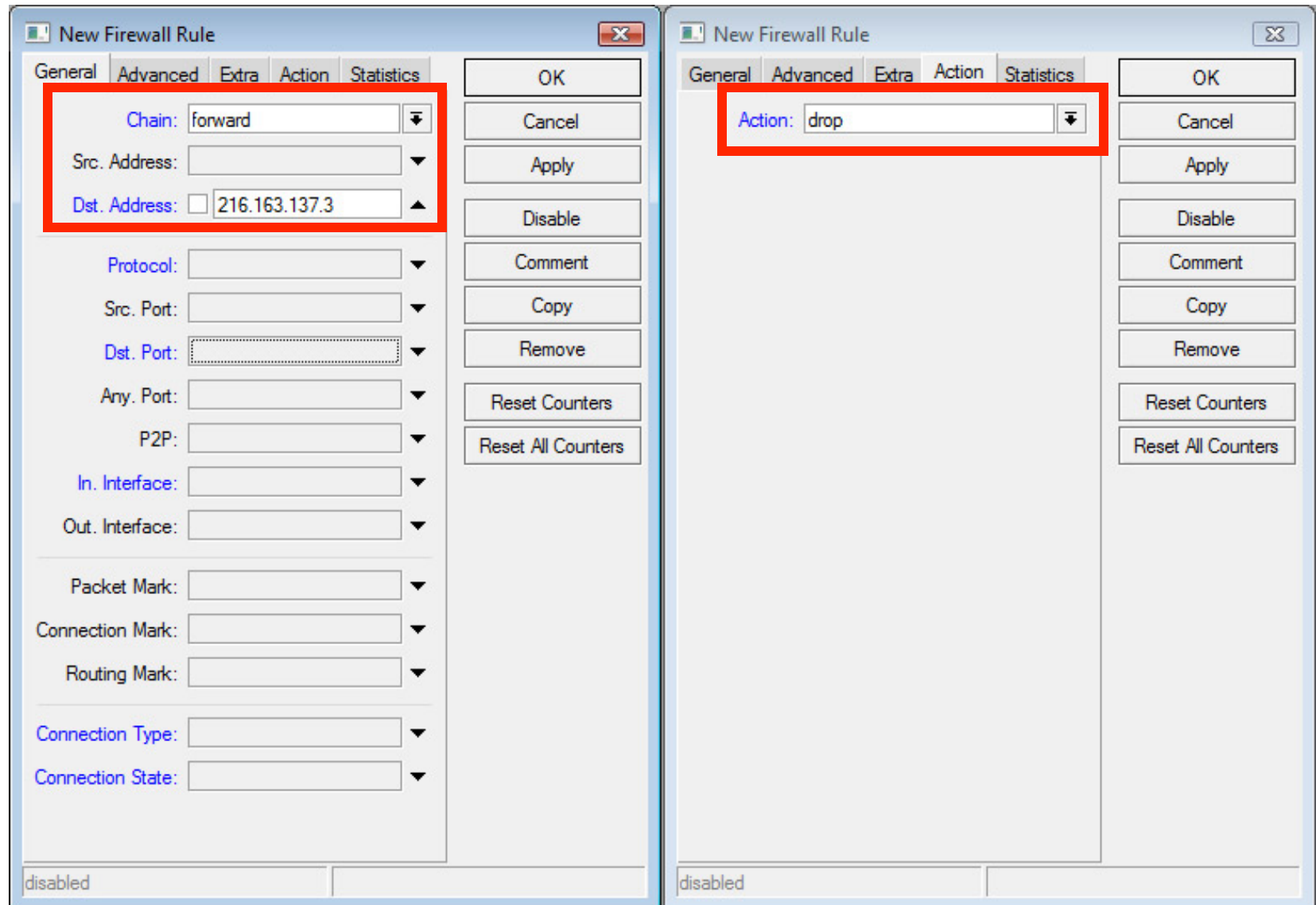

IP Address List

- Kita dapat melakukan pengelompokan IP Address dengan **Address List**
- Address List (seperti halnya mangle) bisa dijadikan parameter dalam pembuatan filter, queue, mangle, NAT, dll.
- Dengan Filter dan Mangle, kita bisa secara otomatis memasukkan IP Address tertentu ke dalam **address list** dan juga menentukan jangka waktu expire nya.

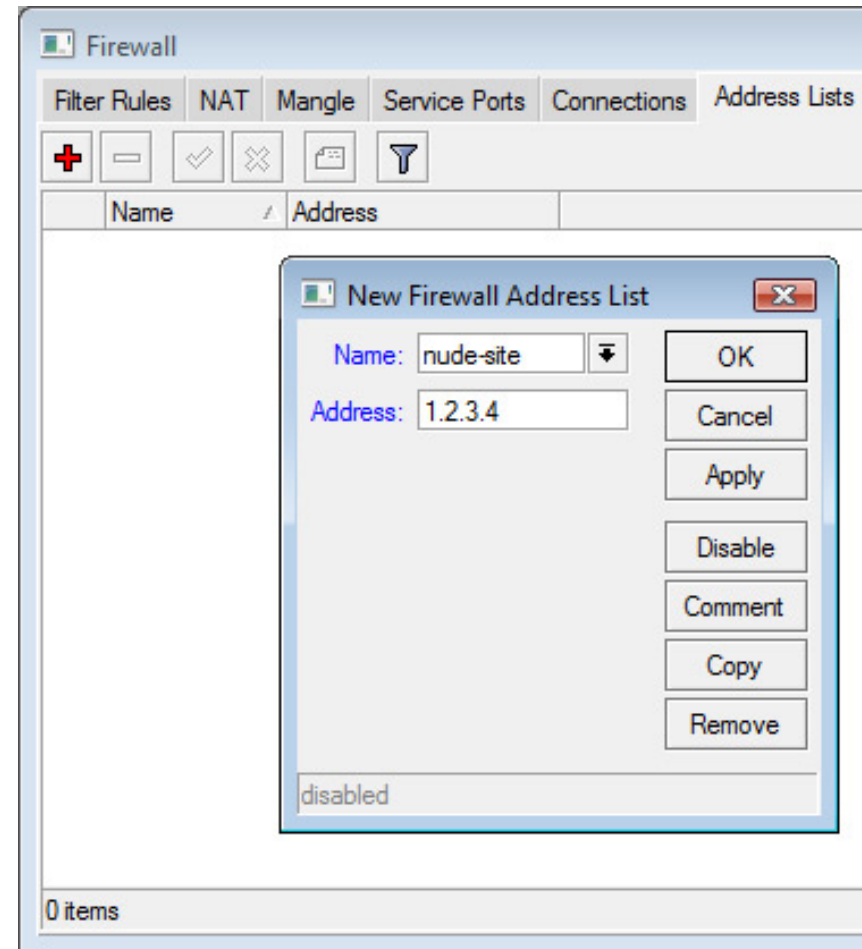



Network Address Translation (NAT)

- NAT digunakan untuk melakukan pengubahan baik src-address ataupun dst-address.
- Setelah paket data pertama dari sebuah koneksi terkena NAT, maka paket berikutnya pada koneksi tersebut juga akan terkena NAT.
- NAT akan diproses terurut mulai baris paling atas hingga ke bawah.

Firewall NAT

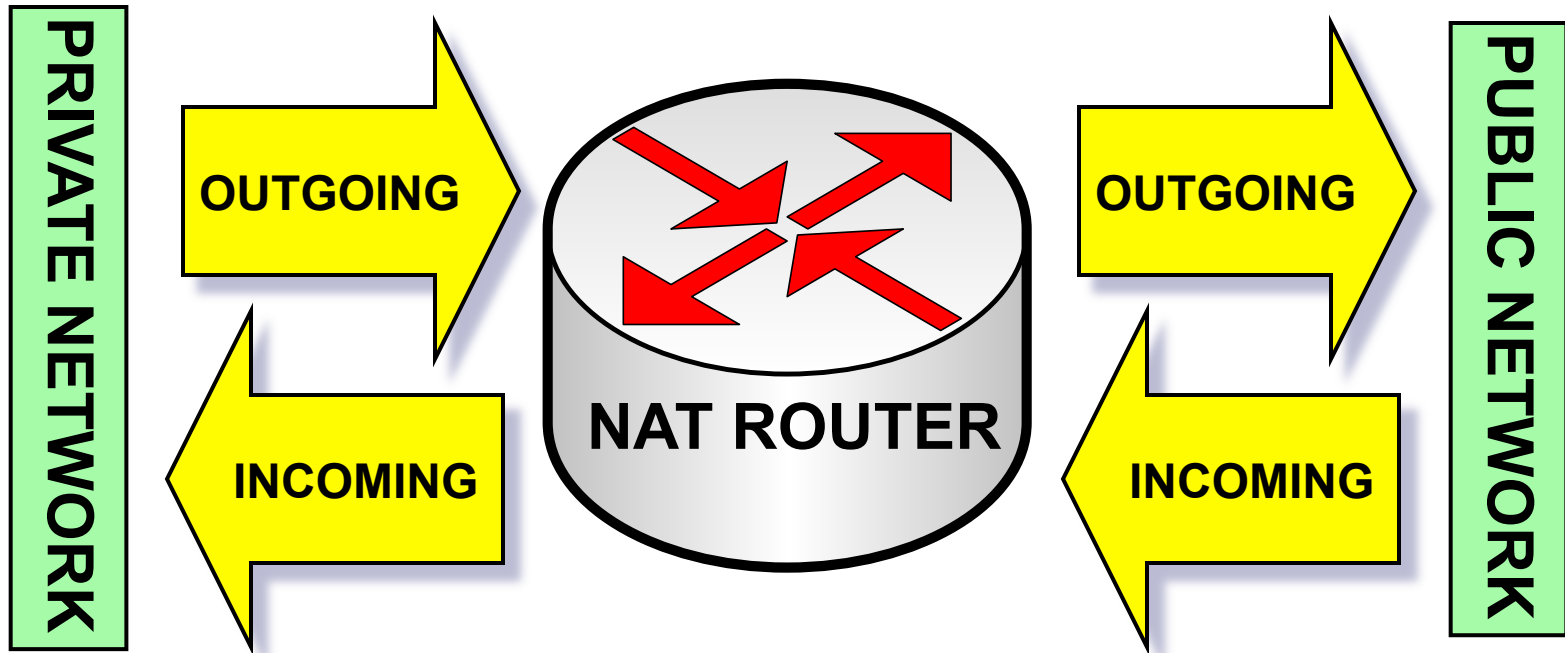

The NAT router translates traffic coming into and leaving the private network

Firewall NAT

The screenshot displays the Mikrotik WinBox v3.2 interface. The top bar shows the user is logged in as 'admin@00:0C:42:1B:5C:C1 (MikroTik)' on an 'RB500R5 (mipsle)' device. The left sidebar contains a navigation tree with 'IP' and 'Firewall' highlighted. The main window shows the 'Firewall' configuration page with the 'NAT' tab selected. A 'NAT Rule' dialog box is open, showing the 'General' tab. The 'Chain' is set to 'srcnat'. The 'Out. Interface' is set to 'wlan1'. The 'Connection Type' is set to 'nat'. The 'Action' tab is also visible, showing a 'mas...' rule.

src-nat and masquerade

- Untuk menyembunyikan IP Address lokal dan menggantikannya dengan IP Address publik yang sudah terpasang pada router
- **src-nat**
 - Kita bisa memilih IP Address publik yang digunakan untuk menggantikan.
- **masquerade**
 - Secara otomatis akan menggunakan IP Address pada interface publik.
 - Digunakan untuk mempermudah instalasi dan bila IP Address publik pada interface publik menggunakan IP Address yang dinamik (misalnya DHCP, PPTP atau EoIP)

● ● ● | dst-nat and redirect

- Untuk melakukan penggantian IP Address tujuan, atau mengarahkan koneksi ke localhost.
- **dst-nat**
 - Kita bisa mengganti IP Address dan port tujuan dari sesuatu koneksi.
- **redirect**
 - Untuk mengalihkan koneksi yang tadinya melwati router, dan dialihkan menuju ke localhost

Konsep Proxy

- Pada semua level routers, baik yang diinstall pada PC maupun yang diinstall pada routerboard, kita bisa mengaktifkan fitur proxy
- Koneksi tanpa proxy

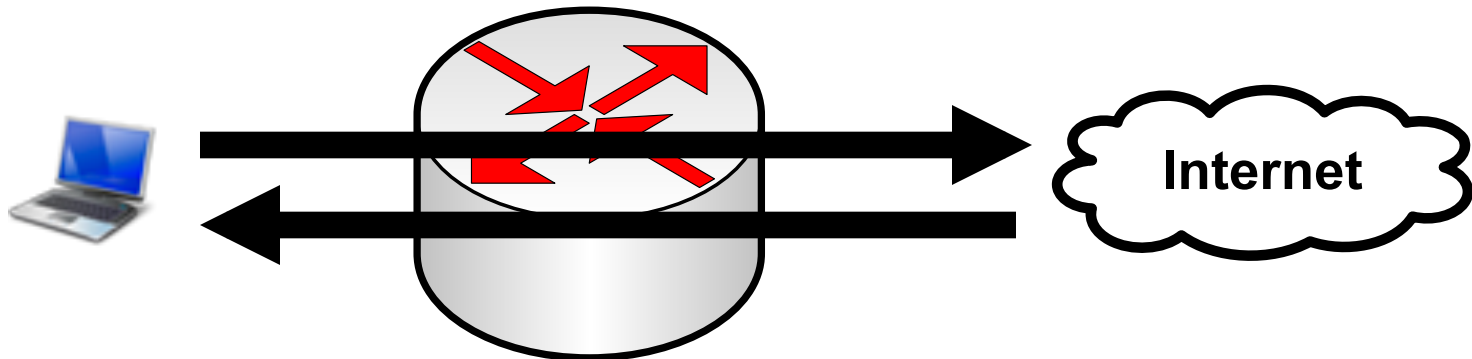

- Koneksi dengan proxy

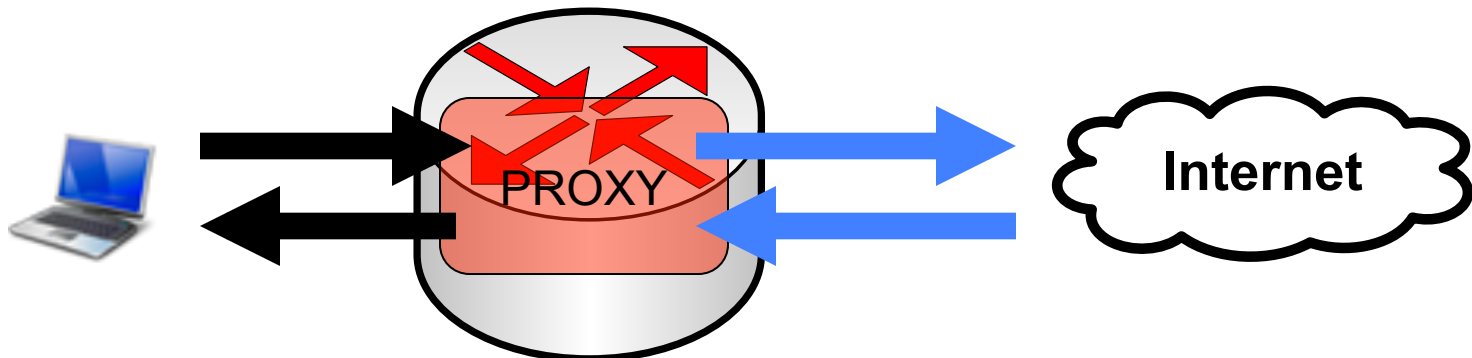

Fitur Proxy di RouterOS

- **Regular HTTP proxy**
- **Transparent proxy**
 - Dapat berfungsi juga sebagai transparan dan sekaligus normal pada saat yang bersamaan
- **Access list**
 - Berdasarkan source, destination, URL dan requested method
- **Cache Access list**
 - Menentukan objek mana yang disimpan pada cache
- **Direct Access List**
 - Mengatur koneksi mana yang diakses secara langsung dan yang melalui proxy server lainnya
- **Logging facility**

● ● ● | [LAB-5] dst-nat & local proxy

- Aktifkanlah service **web-proxy** pada router Anda.
- Lakukanlah pengalihan koneksi secara **transparan** sehingga semua koneksi HTTP akan **melalui web proxy** pada router.

Mengaktifkan Proxy

The screenshot shows the Mikrotik WinBox interface for configuring the Web Proxy. The left sidebar has a tree view with 'Web Proxy' selected. The main window shows the 'Web Proxy Settings' dialog box. The 'General' tab is active, and the 'Enabled' checkbox is checked. The 'Src. Address' and 'Port' fields are highlighted with red boxes. The 'Port' is set to 3128. Other settings include 'Parent Proxy', 'Parent Proxy Port', 'Cache Drive' (system), 'Cache Administrator' (webmaster), 'Max. Cache Size' (none), 'Cache On Disk' (unchecked), 'Max. Client Connections' (600), 'Max. Server Connections' (600), 'Max Fresh Time' (3d 00:00:00), 'Serialize Connections' (unchecked), 'Always From Cache' (unchecked), and 'Cache Hit DSCP (TOS)' (4).

admin@00:0C:42:1B:5C:C1 (MikroTik) - WinBox v3.2 on RB500R5 (mipsle)

Web Proxy Settings

Web Proxy Settings

General Status Lookups Inserts

Enabled

Src. Address: []

Port: 3128

Parent Proxy: []

Parent Proxy Port: []

Cache Drive: system

Cache Administrator: webmaster

Max. Cache Size: none KIB

Cache On Disk

Max. Client Connections: 600

Max. Server Connections: 600

Max Fresh Time: 3d 00:00:00

Serialize Connections

Always From Cache

Cache Hit DSCP (TOS): 4

running

Redirect TCP-80

The image displays two windows from the Mikrotik WinBox interface. The left window, titled "NAT Rule <80>", shows the configuration for an existing NAT rule. The right window, titled "New NAT Rule", shows the configuration for a new NAT rule. Both windows have tabs for "General", "Advanced", "Extra", "Action", and "Statistics".

NAT Rule <80> Configuration:

- Chain: dstnat
- Src. Address: [Empty]
- Dst. Address: [Empty]
- Protocol: 6 (tcp)
- Src. Port: [Empty]
- Dst. Port: 80
- Any. Port: [Empty]
- In. Interface: ether1
- Out. Interface: [Empty]
- Packet Mark: [Empty]
- Connection Mark: [Empty]
- Routing Mark: [Empty]
- Connection Type: [Empty]

New NAT Rule Configuration:

- Action: redirect
- To Ports: 3128

Buttons on the right side of the "New NAT Rule" window include: OK, Cancel, Apply, Disable, Comment, Copy, Remove, Reset Counters, and Reset All Counters.

Akses

- Mengatur hak akses client (Access Filter)

The image shows the Mikrotik WinBox interface for configuring an Access Filter. It consists of three main panels:

- Web Proxy:** A table with columns for #, Src. Address, and a status indicator. A red circle highlights the '+' button used to add a new rule.
- New Web Proxy Rule:** A configuration dialog with the following fields:
 - Src. Address: []
 - Dst. Address: []
 - Dst. Port: []
 - Local Port: []
 - Dst. Host: []
 - Path: /*mp3
 - Method: []
 - Action: deny
 - Redirect To: []
 - Hits: 0
- Web Proxy Rule <>:** A configuration window for the selected rule, showing:
 - Src. Address: []
 - Dst. Address: []
 - Dst. Port: []
 - Local Port: []
 - Dst. Host: *yahoo*
 - Path: []
 - Method: []
 - Action: deny
 - Redirect To: []
 - Hits: 0

Red lines connect the '+' button to the 'New Web Proxy Rule' dialog, and the 'Path' and 'Action' fields in the dialog to the corresponding fields in the 'Web Proxy Rule <>' window.

System Store - Disk

- Penyimpanan Cache
 - System Disk
 - Hardisk
 - Flash memory
- Format terlebih dahulu

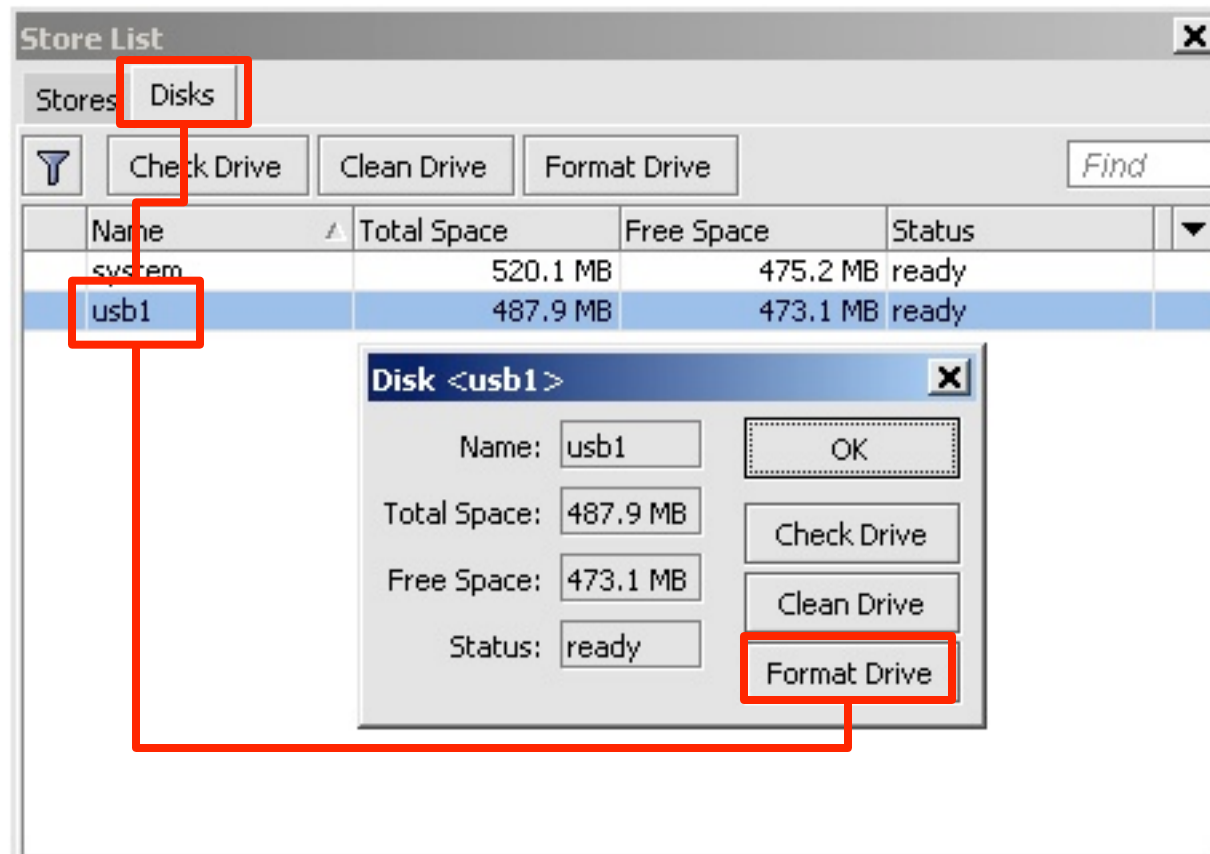

System Store – Store Mount

- Setelah diformat Disk di mount untuk service proxy.

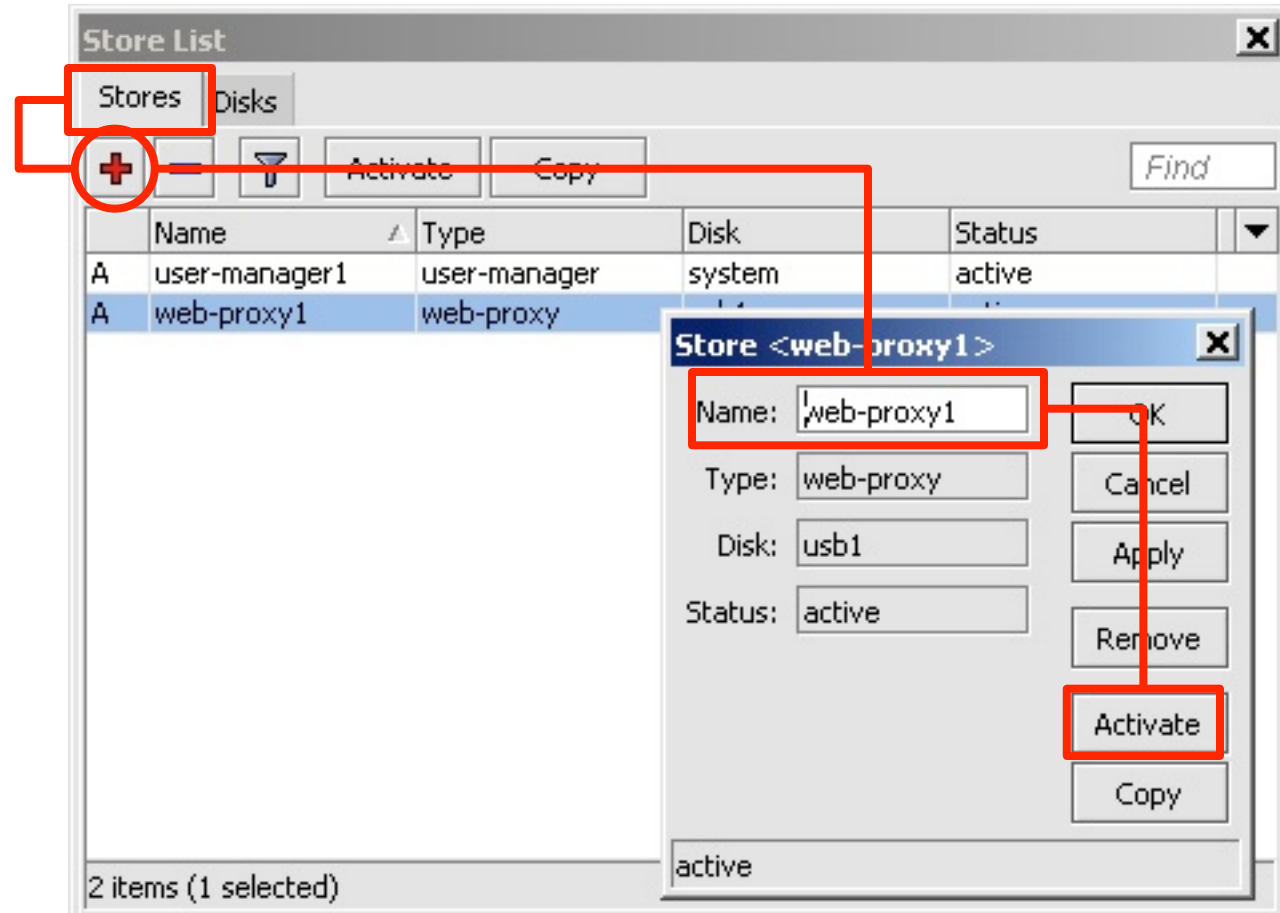

Proxy - Cache

- Aktifkan “Cache On Disk” untuk mengaktifkan Mikrotik Proxy Cache.
- Perhatikan pada parameter “Cache Drive” sudah menggunakan USB disk.

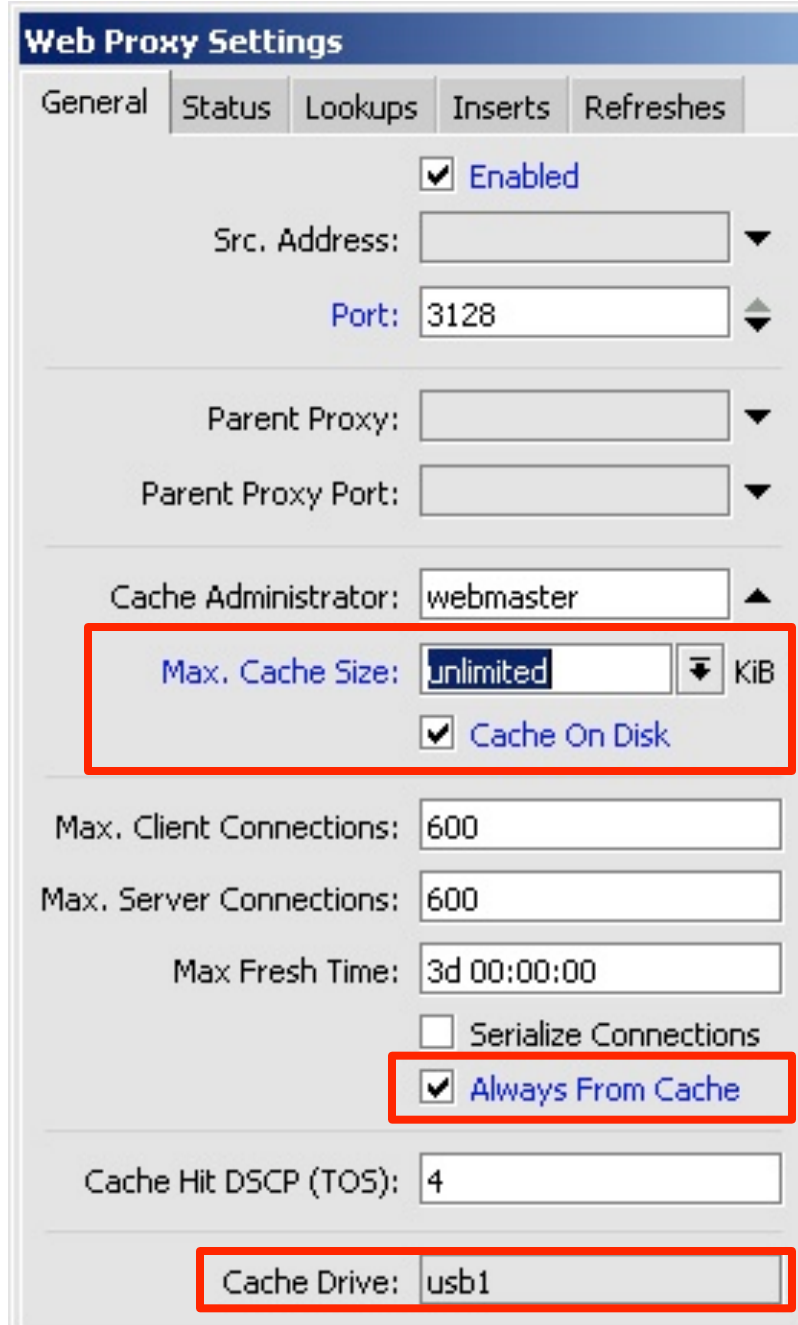

Web Proxy Settings

General | Status | Lookups | Inserts | Refreshes

Enabled

Src. Address:

Port: 3128

Parent Proxy:

Parent Proxy Port:

Cache Administrator: webmaster

Max. Cache Size: unlimited KIB

Cache On Disk

Max. Client Connections: 600

Max. Server Connections: 600

Max Fresh Time: 3d 00:00:00

Serialize Connections

Always From Cache

Cache Hit DSCP (TOS): 4

Cache Drive: usb1



Daftar Protokol dan Port yang Sebaiknya Ditutup



Karena Virus, Spyware, dll

Block Bogus IP Address

- add chain=forward src-address=0.0.0.0/8
action=drop
- add chain=forward dst-address=0.0.0.0/8
action=drop
- add chain=forward src-address=127.0.0.0/8
action=drop
- add chain=forward dst-address=127.0.0.0/8
action=drop
- add chain=forward src-address=224.0.0.0/3
action=drop
- add chain=forward dst-address=224.0.0.0/3
action=drop

Separate Protocol into Chains

- add chain=forward protocol=tcp
action=jump jump-target=tcp
- add chain=forward protocol=udp
action=jump jump-target=udp
- add chain=forward protocol=icmp
action=jump jump-target=icmp

Blocking UDP Packet

- add chain=udp protocol=udp dst-port=69
action=drop comment="deny TFTP"
- add chain=udp protocol=udp dst-port=111
action=drop comment="deny PRC portmapper"
- add chain=udp protocol=udp dst-port=135
action=drop comment="deny PRC portmapper"
- add chain=udp protocol=udp dst-port=137-139
action=drop comment="deny NBT"
- add chain=udp protocol=udp dst-port=2049
action=drop comment="deny NFS"
- add chain=udp protocol=udp dst-port=3133
action=drop comment="deny BackOriffice"



Only needed icmp codes in icmp chain

- add chain=icmp protocol=icmp icmp-options=0:0 action=accept comment="drop invalid connections"
- add chain=icmp protocol=icmp icmp-options=3:0 action=accept comment="allow established connections"
- add chain=icmp protocol=icmp icmp-options=3:1 action=accept comment="allow already established connections"
- add chain=icmp protocol=icmp icmp-options=4:0 action=accept comment="allow source quench"
- add chain=icmp protocol=icmp icmp-options=8:0 action=accept comment="allow echo request"
- add chain=icmp protocol=icmp icmp-options=11:0 action=accept comment="allow time exceed"
- add chain=icmp protocol=icmp icmp-options=12:0 action=accept comment="allow parameter bad"
- add chain=icmp action=drop comment="deny all other types"

Deny Some TCP Ports

- add chain=tcp protocol=tcp dst-port=69 action=drop comment="deny TFTP"
- add chain=tcp protocol=tcp dst-port=111 action=drop comment="deny RPC portmapper"
- add chain=tcp protocol=tcp dst-port=135 action=drop comment="deny RPC portmapper"
- add chain=tcp protocol=tcp dst-port=137-139 action=drop comment="deny NBT"
- add chain=tcp protocol=tcp dst-port=445 action=drop comment="deny cifs"
- add chain=tcp protocol=tcp dst-port=2049 action=drop comment="deny NFS"
- add chain=tcp protocol=tcp dst-port=12345-12346 action=drop comment="deny NetBus"
- add chain=tcp protocol=tcp dst-port=20034 action=drop comment="deny NetBus"
- add chain=tcp protocol=tcp dst-port=3133 action=drop comment="deny BackOriffice"
- add chain=tcp protocol=tcp dst-port=67-68 action=drop comment="deny DHCP"



Virus and Worms (1)

- Worm tcp dst-port=135-139
- Messenger Worm udp dst-port=135-139
- Blaster Worm tcp dst-port=445
- Blaster Worm udp dst-port=445
- Virus tcp dst-port=593
- Virus tcp dst-port=1024-1030
- MyDoom tcp dst-port=1080
- Virus tcp dst-port=1214
- ndm requester tcp dst-port=1363
- ndm server tcp dst-port=1364
- screen cast tcp dst-port=1368
- hromgrafx tcp dst-port=1373
- cichlid tcp dst-port=1377
- Worm tcp dst-port=1433-1434
- Bagle Virus tcp dst-port=2745



Virus and Worms (2)

- Dumaru.Y tcp dst-port=2283
- Beagle tcp dst-port=2535
- Beagle.C-K tcp dst-port=2745
- MyDoom tcp dst-port=3127-3128
- Backdoor OptixPro tcp dst-port=3410
- Worm tcp dst-port=4444
- Worm udp dst-port=4444
- Sasser tcp dst-port=5554
- Beagle.B tcp dst-port=8866
- Dabber.A-B tcp dst-port=9898
- Dumaru.Y tcp dst-port=10000
- MyDoom.B tcp dst-port=10080
- NetBus tcp dst-port=12345
- Kuang2 tcp dst-port=17300
- SubSeven tcp dst-port=27374
- PhatBot, Gaobot tcp dst-port=65506



Quality of Service



Certified Mikrotik Training Basic Class

Organized by: Citraweb Nusa Infomedia

(Mikrotik Certified Training Partner)

Quality of Service

- **QoS** tidak selalu berarti pembatasan bandwidth
- Adalah cara yang digunakan untuk **mengatur penggunaan bandwidth yang ada secara rasional.**
- Qos bisa digunakan juga untuk mengatur prioritas berdasarkan parameter yang diberikan, menghindari terjadinya trafik yang memonopoli seluruh bandwidth yang tersedia.

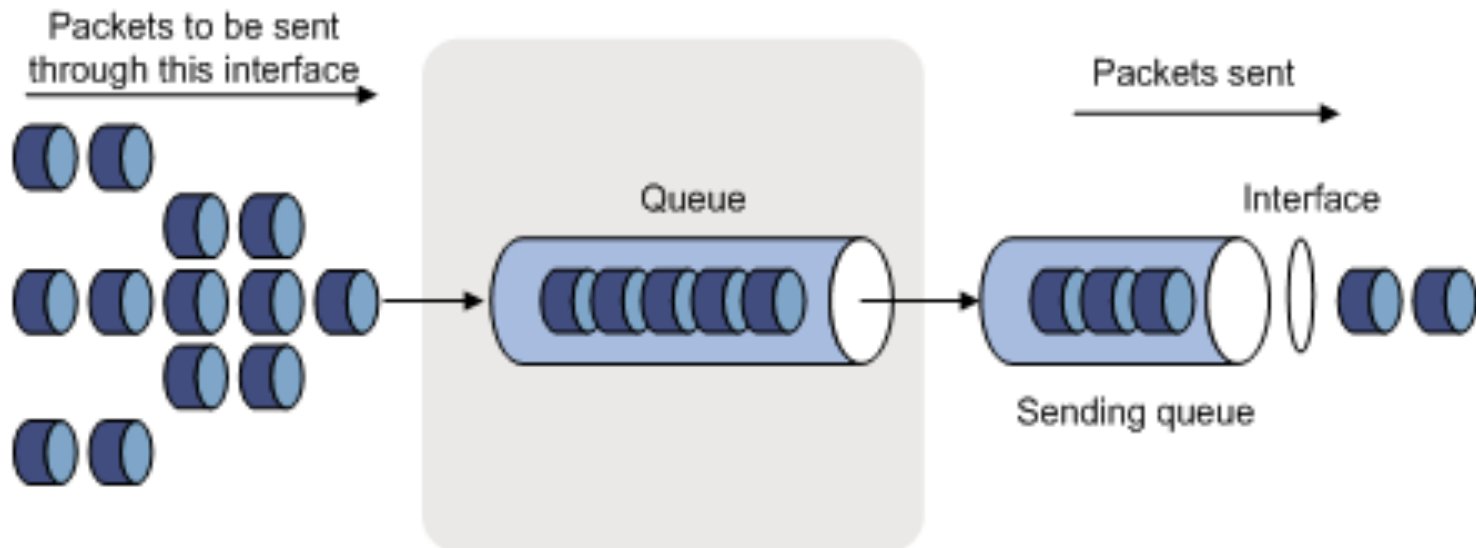



Quality of Service

- Kita tidak dapat melakukan pembatasan trafik yang masuk ke suatu interface.
- Satu-satunya cara untuk mengontrol adalah dengan buffering (menahan sementara), atau kalau melampaui limit buffer, akan dilakukan drop pada paket tersebut.
- Pada TCP, paket yang didrop akan dikirimkan ulang sehingga tidak ada kehilangan paket data.
- Cara termudah melakukan queue di RouterOS adalah menggunakan simple queue.



Simple Queue

- Dengan simple queue, kita dapat melakukan:
 - Melimit tx-rate client (upload)
 - Melimit rx-rate client (download)
 - Melimit tx+rx-rate client (akumulasi)

Simple Queue Menu

MAX Limit :
Limitasi bandwidthnya

Target Address :
IP Address client yang akan dilimit

New Simple Queue

Advanced Statistics Traffic Total Total Statistics

Name: queue3

Target Address:

Target Upload Target Download

Max Limit: unlimited unlimited bits/s

Burst

Burst Limit: unlimited unlimited bits/s

Burst Threshold: unlimited unlimited bits/s

Burst Time: 0 0 s

Time

Time: 00:00:00 - 1d 00:00:00

sun mon tue wed thu fri sat

disabled

Cancel Apply Disable Copy Remove



[LAB-1] Simple Queue 1

- Make a simple queue for your laptop
 - Downstream : 128 kbps
 - Upstream : 64 kbps
- Try Using **Time** (based from system clock)

[LAB-1] Simple Queue

New Simple Queue

General | Advanced | Statistics | Traffic | Total | Total Statistics

Name: queue-simple 1

Target Address: 192.168.x.2

Target Upload Target Download

Max Limit: 64k 128k bits/s

Burst

Burst Limit: unlimited unlimited bits/s

Burst Threshold: unlimited unlimited bits/s

Burst Time: 0 0 s

Time

Time: 07:00:00 - 17:00:00

sun mon tue wed thu fri sat



Burst

- Burst adalah salah satu cara menjalankan QoS
- Burst memungkinkan penggunaan data-rate yang melebihi max-limit untuk periode waktu tertentu
- Jika data rate lebih kecil dari **burst-threshold**, burst dapat dilakukan hingga data-rate mencapai **burst-limit**
- Setiap detik, router mengkalkulasi data rate rata-rata pada suatu kelas queue untuk periode waktu terakhir sesuai dengan **burst-time**
- **Burst time** tidak sama dengan waktu yang diijinkan untuk melakukan burst.

Contoh Burst (1)

- **Max-limit=256kbps, burst-time=8, burst-threshold=192kbps, burst-limit=512kbps.**

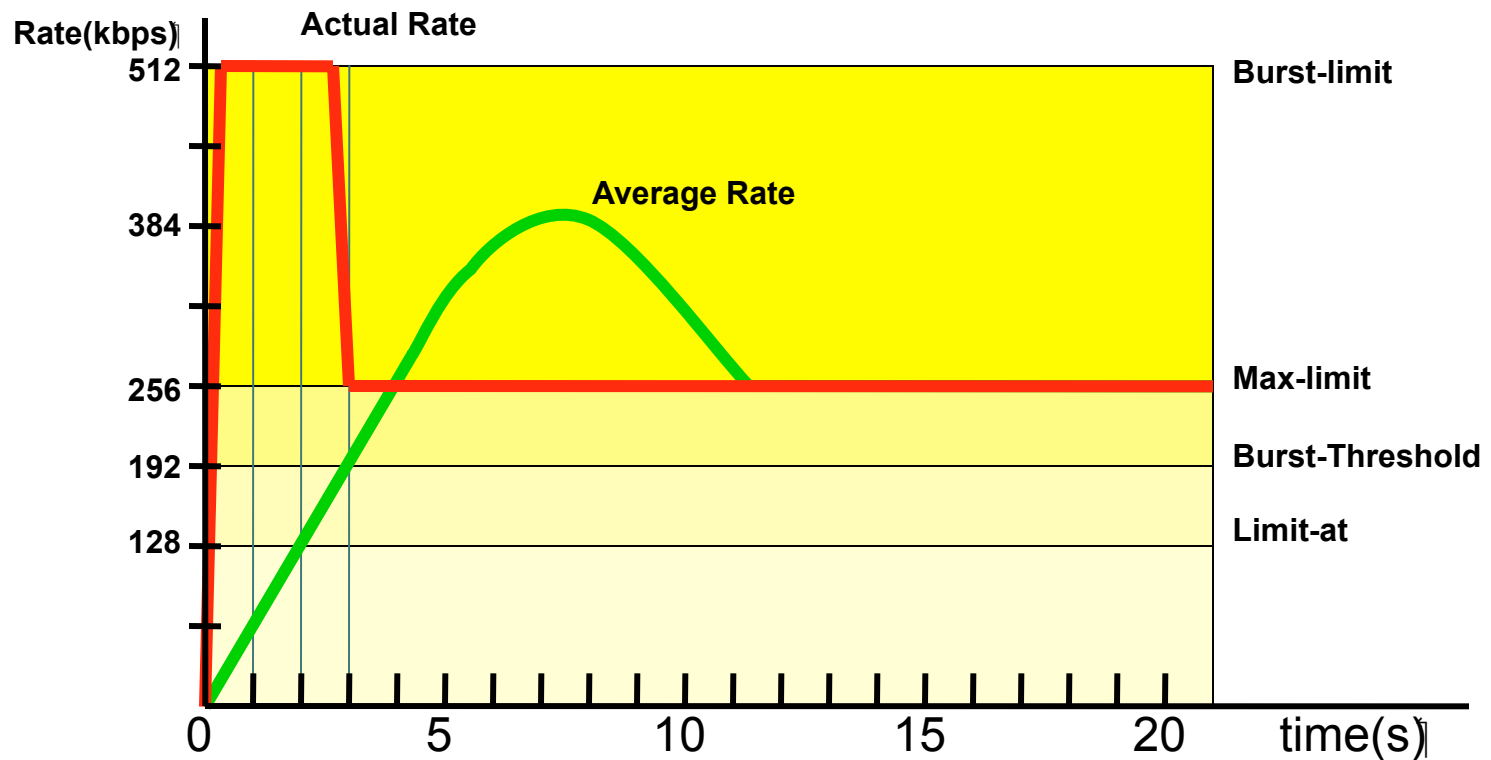

Contoh Burst (1)

- Pada awalnya, data rate rata-rata dalam 8 detik terakhir adalah 0 kbps. Karena data rate rata-rata ini lebih kecil dari burst-threshold, maka burst dapat dilakukan.
- Setelah 1 detik, data rate rata-rata adalah $(0+0+0+0+0+0+0+512)/8=64\text{kbps}$, masih lebih kecil dari **burst-threshold**. Burst dapat dilakukan.
- Demikian pula untuk detik kedua, data rate rata-rata adalah $(0+0+0+0+0+0+512+512)/8=128\text{kbps}$.
- Setelah 3 detik, tibalah pada saat di mana data rate rata-rata lebih besar dari **burst-threshold**. Burst tidak dapat lagi dilakukan, dan data rate turun menjadi **max-limit** (256kbps).

Contoh Burst (2)

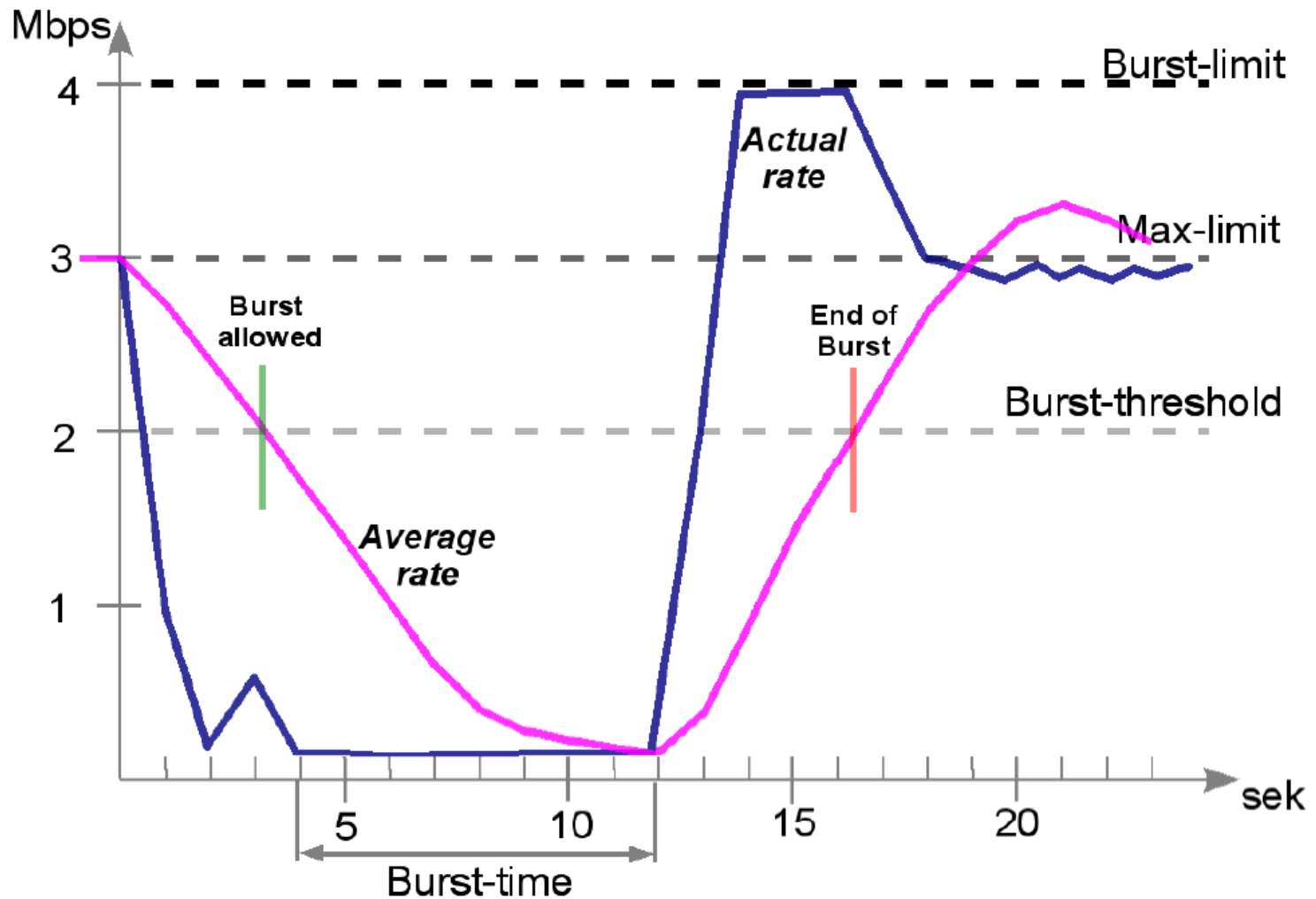

● ● ● | [LAB-2] Simple Queue 2

- Make a simple queue for your laptop
 - Downstream max-limit=256k
 - Upstream max-limit=128k
- Try Using Burst
 - Burst-limit=1M
 - Burst-threshold=512K
 - Burst-time=30s

[LAB-2] Simple Queue 2

New Simple Queue

General | Advanced | Statistics | Traffic | Total | Total Statistics

Name:

Target Address:

Target Upload Target Download

Max Limit: bits/s

—▲— Burst

Burst Limit: bits/s

Burst Threshold: bits/s

Burst Time: s

—▼— Time

Simple Queue – Bandwidth Test

- **Address :**
 - Ip address test server
- **Direction :**
 - Upload
 - Download
 - Upload & Download
- **Protocol :**
 - TCP / UDP
- **User & Password :**
 - Autentikasi

MikroTik Bandwidth Test v0.1

MikroTik.com

Address: 10.10.10.30

Protocol: tcp

Local Tx Size: 1500 bytes

Remote Tx Size: 1500 bytes

Direction: both

Local Tx Speed: bps

Remote Tx Speed: bps

User: admin

Password:

Random Data

Start

Settings...

Help...

Save

Load #1

Load #2

Load #3

Load #4

Load #5



Staged Limitation

- Pada RouterOS, dikenal 2 buah limitasi:
 - **CIR** (Committed Information Rate)
 - dalam keadaan terburuk, client akan mendapatkan bandwidth sesuai dengan “**limit-at**” (dengan asumsi bandwidth yang tersedia cukup untuk CIR semua client)
 - **MIR** (Maximal Information Rate)
 - jika masih ada bandwidth yang tersisa setelah semua client mencapai “**limit-at**”, maka client bisa mendapatkan bandwidth tambahan hingga “**max-limit**”

Staged Limitation - Example



Internet

Total Bandwidth : 1 Mbps

○ Bandwidth share
1Mbps 1:4



Client 2 Bandwidth:
Min : 256Kbps
Up-to 1Mbps



Client 4 Bandwidth:
Min : 256Kbps
Up-to 1Mbps

Client 1 Bandwidth:
Min : 256Kbps
Up-to 1Mbps



Client 3 Bandwidth:
Min : 256Kbps
Up-to 1Mbps



[LAB-3] Staged Queue - Parent

- Parent queue harus dibuat terlebih dahulu untuk membantu router menentukan Total bandwidth yang dimiliki.

New Simple Queue

General | Advanced | Statistics | Traffic | Total | Total Statistics

Name: total bandwidth

Target Address: []

Target Upload Target Download

Max Limit: 1M [v] 1M [v] bits/s

▲ Burst

Burst Limit: unlimited [v] unlimited [v] bits/s

Burst Threshold: unlimited [v] unlimited [v] bits/s

Burst Time: 0 [] 0 [] s

▼ Time

[LAB-3] Staged Queue - Child

- Child queue baru dibuat untuk melimit tiap clientnya.
- Untuk pembagian bandwithnya adalah :
 - **Limit-At = Total Bandwith / Jumlah Client**
 - **Max-Limit = < Total Bandwith**
- Jika jumlah client terlalu banyak maka bisa digunakan perhitungan :
 - **Limit-At = Total Bandwith / jumlah rata-rata maksimal client yang aktif**
 - **Max-Limit = TotalBandwith / jumlah rata-rata minimal client yang aktif**

Name	Parent	Packet Mark	Priority	Limit At ...	Max Limit...	Avg. Rate	
parent	ether3		8		400k	400.6 kbps	
q1	parent	p1	3	75k	200k	133.5 kbps	
q2	parent	p2	3	75k	200k	130.6 kbps	
q3	parent	p3	3	75k	200k	136.4 kbps	

[LAB-3] Staged Queue - Child

New Simple Queue

General | Advanced | Statistics | Traffic | Total | Total Statistics

Name:

Target Address:

Target Upload Target Download

Max Limit:

Burst

Burst Limit:

Burst Threshold:

Burst Time:

Time

New Simple Queue

General | Advanced | Statistics | Traffic | Total | Total Statistics

P2P:

Packet Marks:

Dst. Address:

Interface:

Target Upload Target Download

Limit At: bits/s

Queue Type:

Parent:

Priority:

- Rule child dibuat untuk semua ke empat client

Contoh soal : 1

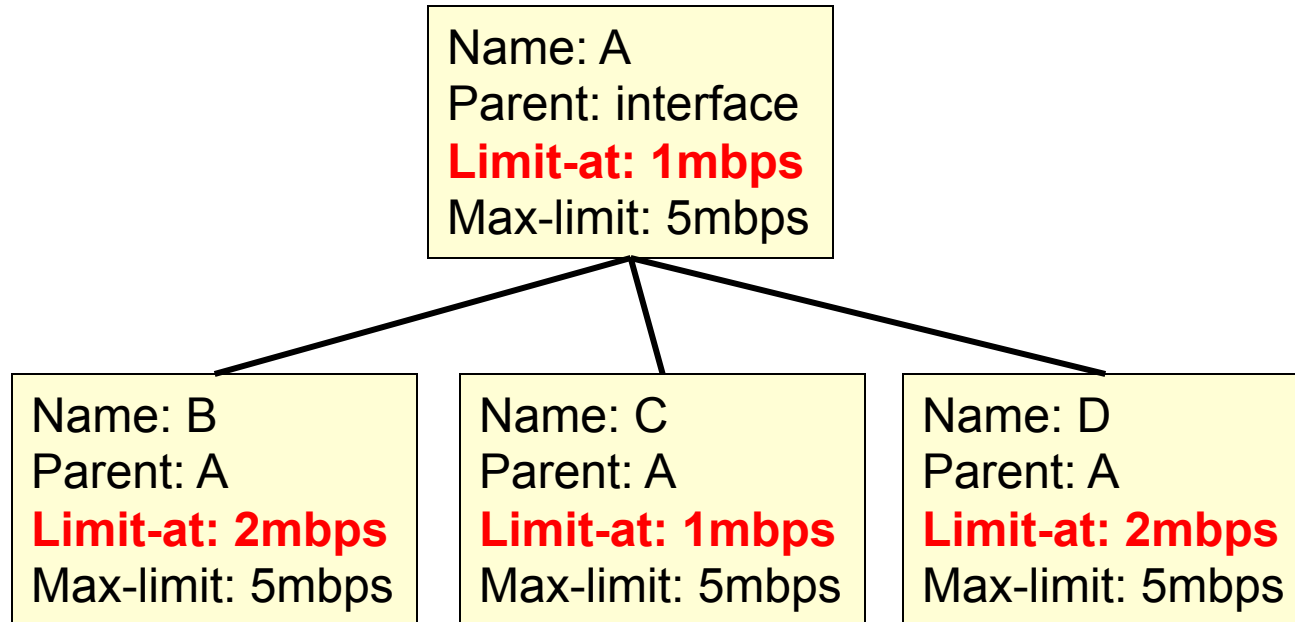

Contoh soal : 2

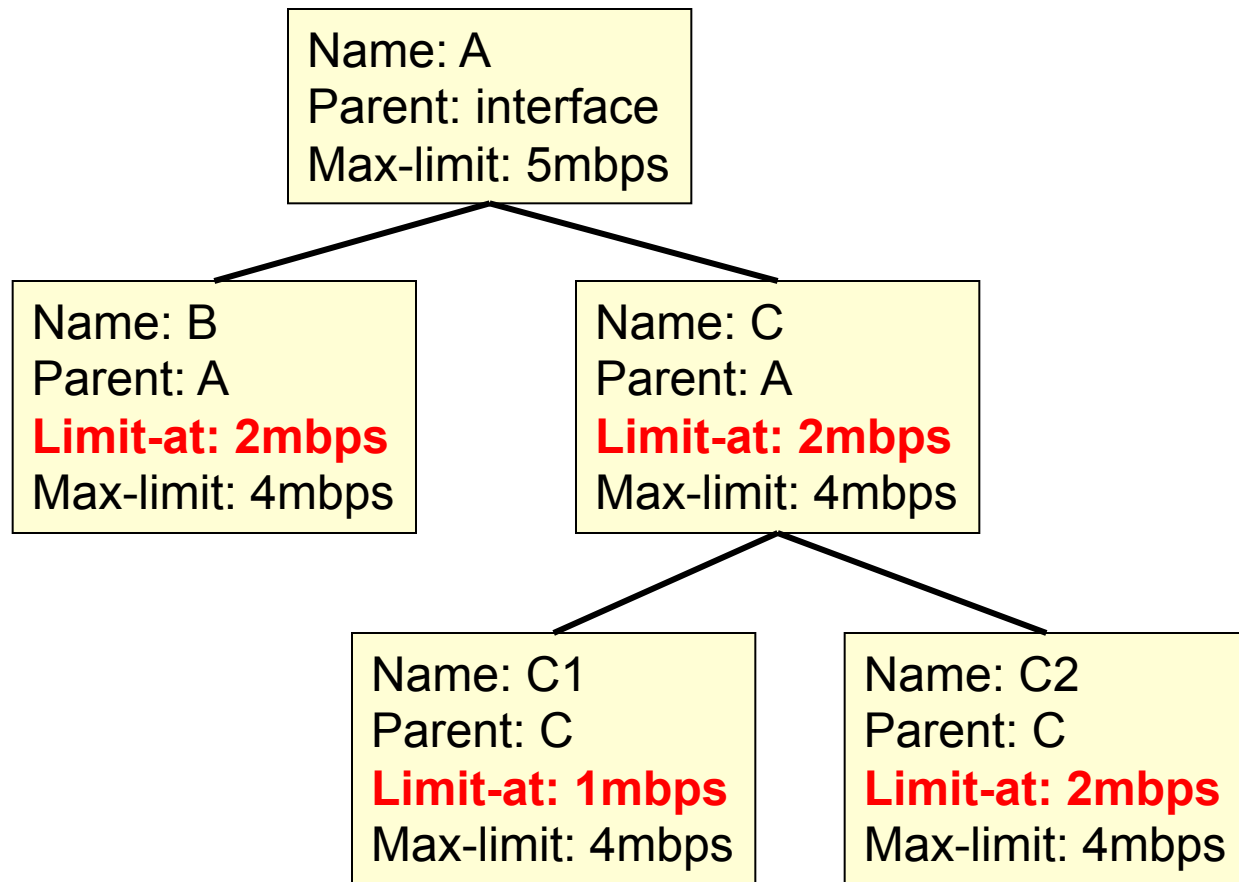

Using Mikrotik Graph

The screenshot displays the Mikrotik WinBox interface. On the left, the 'Tools' menu is highlighted with a red box. The main window shows the 'Graphing' menu, also highlighted with a red box. Below the menu, there are tabs for 'Interface Rules', 'Queue Rules', 'Resource Rules', and 'Interface Graphs'. A 'Graphing Settings' dialog box is open, showing a table with columns for 'Interface', 'Allow Address', and 'Store on ...'. A 'New Interface Graphing Rule' dialog box is also open, showing the following fields:

- Interface: all
- Allow Address: 0.0.0.0/0
- Store on Disk

Buttons for 'OK', 'Cancel', 'Apply', 'Copy', and 'Remove' are visible on the right side of the dialog box.

Graph

Mikrotik Router -> NAT-Lokal -> Graphing - Mozilla Firefox

File Edit View Go Bookmarks Tools Help

http://192.168.1.1

Toko FN Donasi Mikrotik-IND Mikrotik Fotografer.Net KlikBCA

Traffic and system resources

You have access to 1 queue:
[valens-test](#)

You have access to 4 interfaces:
[LAN](#)
[WAN](#)
[ether1](#)
[bridge1](#)

Mikrotik Router -> NAT-Lokal -> Queue Traffic Graphing - Mozilla Firefox

File Edit View Go Bookmarks Tools Help

http://192.168.1.1

Toko FN Donasi Mikrotik-IND Mikrotik Fotografer.Net KlikBCA

Queue Statistics

valens-test

Source-address: 192.168.0.4/32
Destination-address: 0.0.0.0/0
Max-limit: 96.00 Kb/64.00 Kb (Total: *unlimited*)
Limit-at: 64.00 Kb/32.00 Kb (Total: *unlimited*)
Last update: Tue Dec 13 04:21:11 2005

"Daily" Graph (5 Minute Average)

Max In: 67.01 Kb (104.7%) Average In: 66.39 Kb (103.7%) Current In: 66.73 Kb (104.3%)
Max Out: 94.32 Kb (98.2%) Average Out: 90.59 Kb (94.4%) Current Out: 91.06 Kb (94.9%)

"Weekly" Graph (30 Minute Average)

PCQ (Per Connection Queue)

- Untuk kondisi client yang sangat banyak dan sangat merepotkan jika harus membuat banyak rule maka bisa menggunakan metode PCQ :
 - PCQ dibuat sebagai penyempurnaan SFQ.
 - PCQ bisa **membatasi bandwidth client secara merata**
 - PCQ membutuhkan memori yang cukup besar

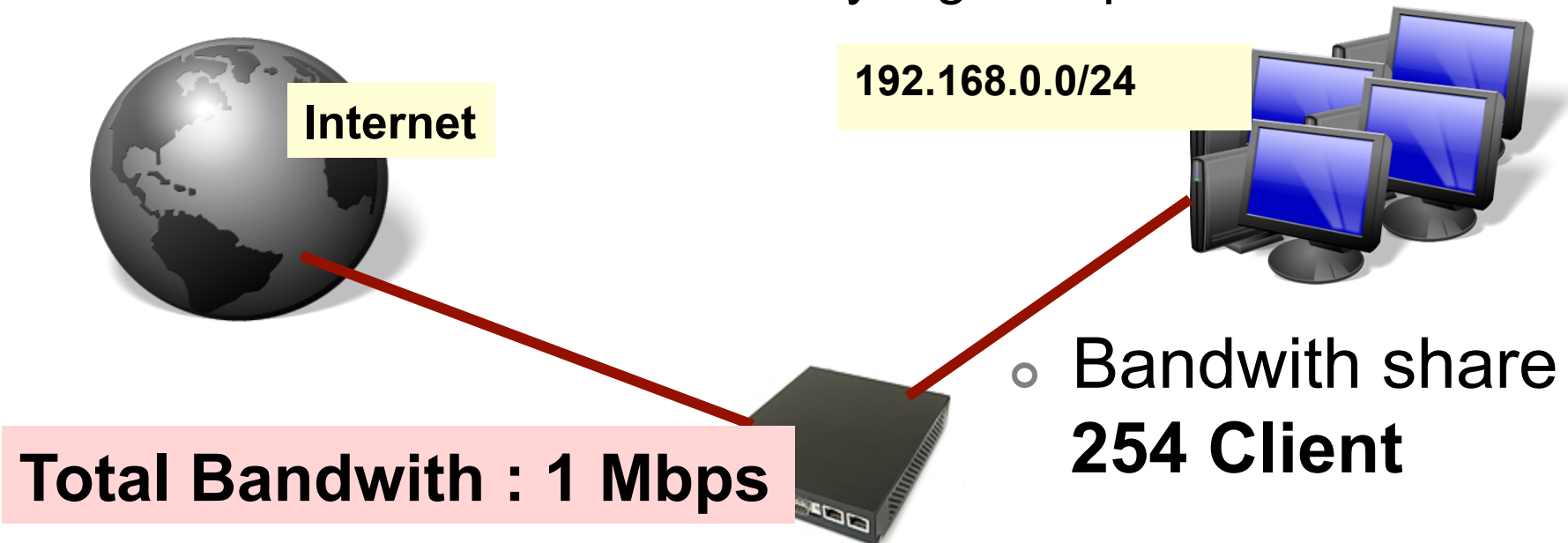

Skema PCQ

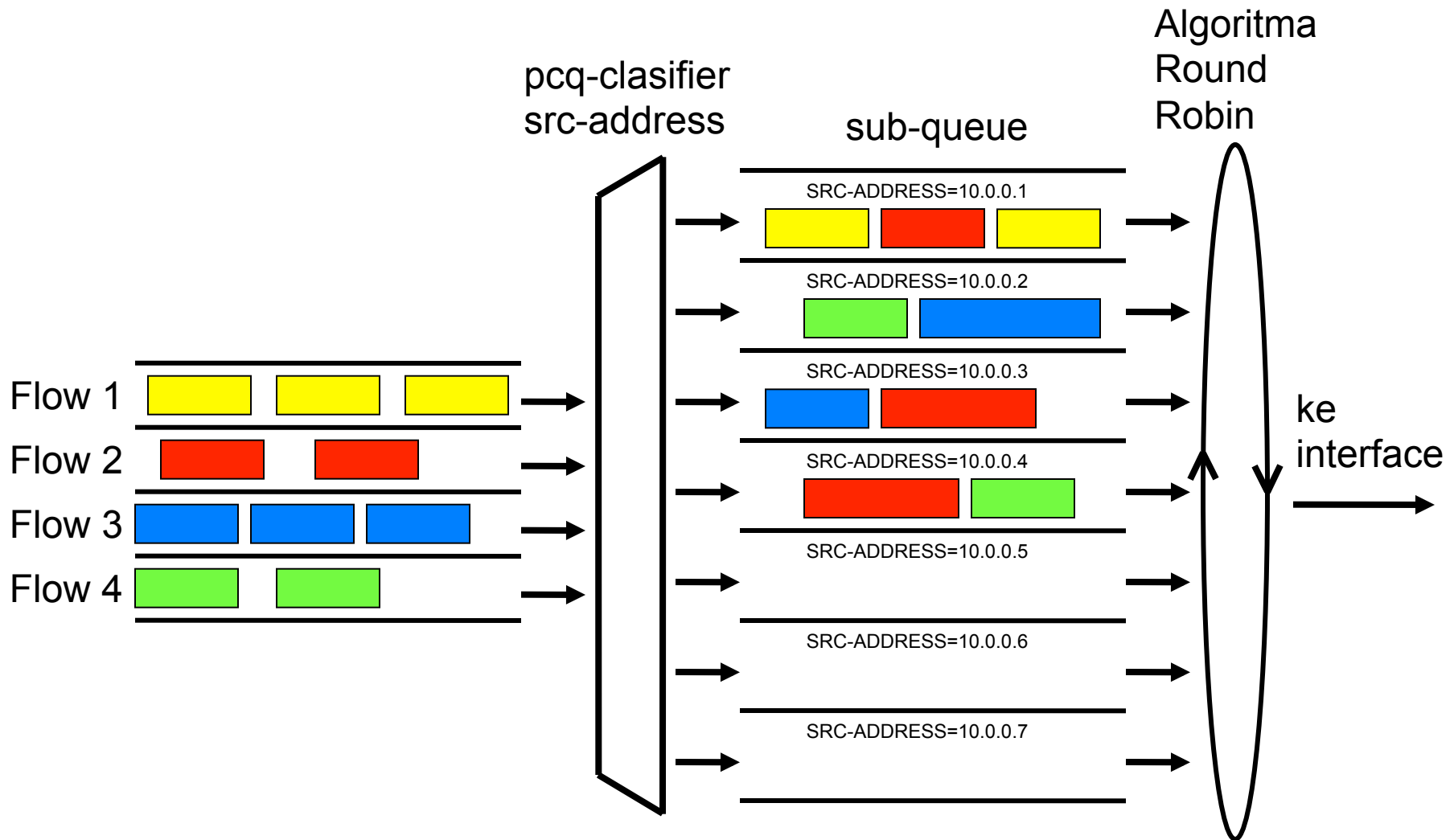

PCQ in Action (1)

- o Pcq-rate=128000

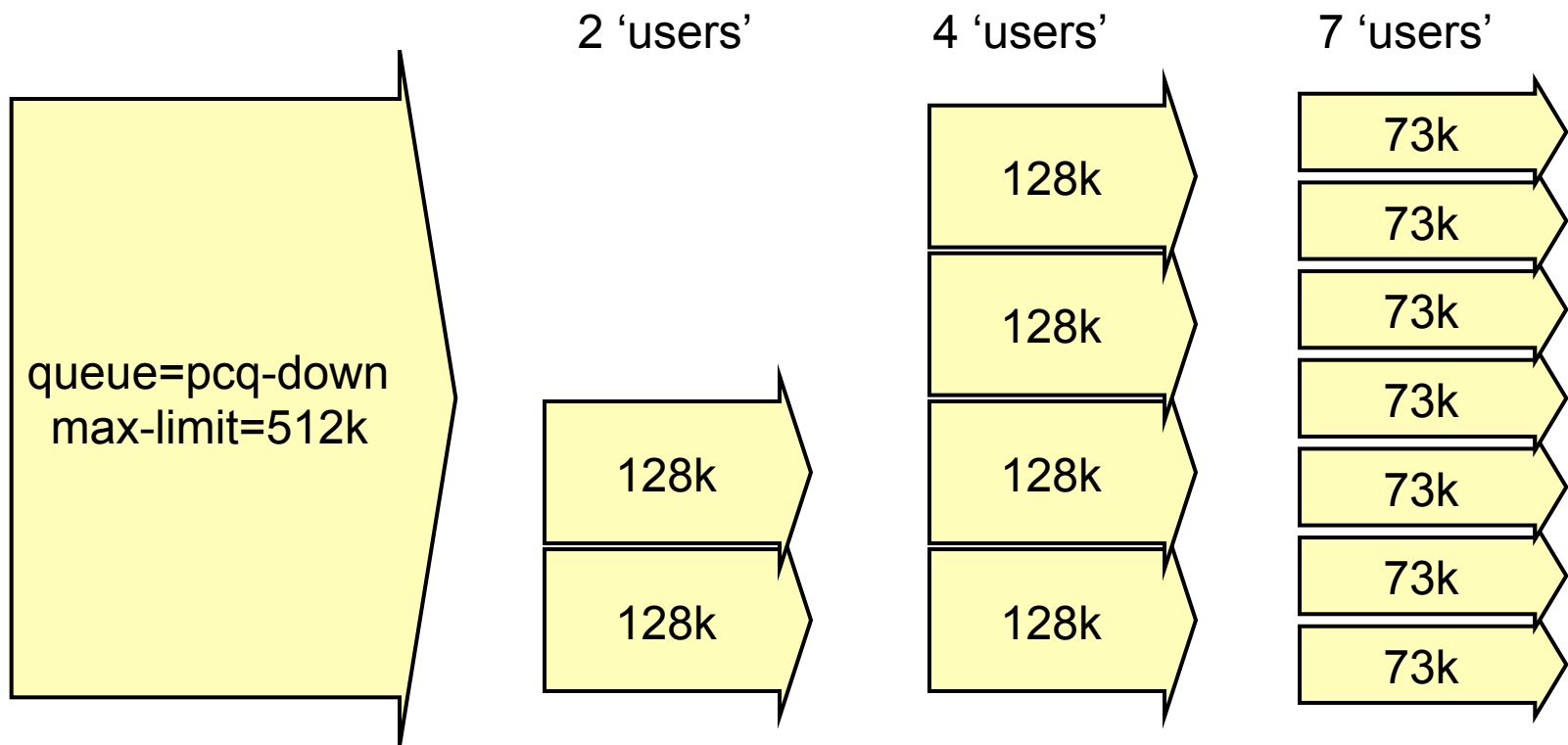

PCQ in Action (2)

- o Pcq-rate=0

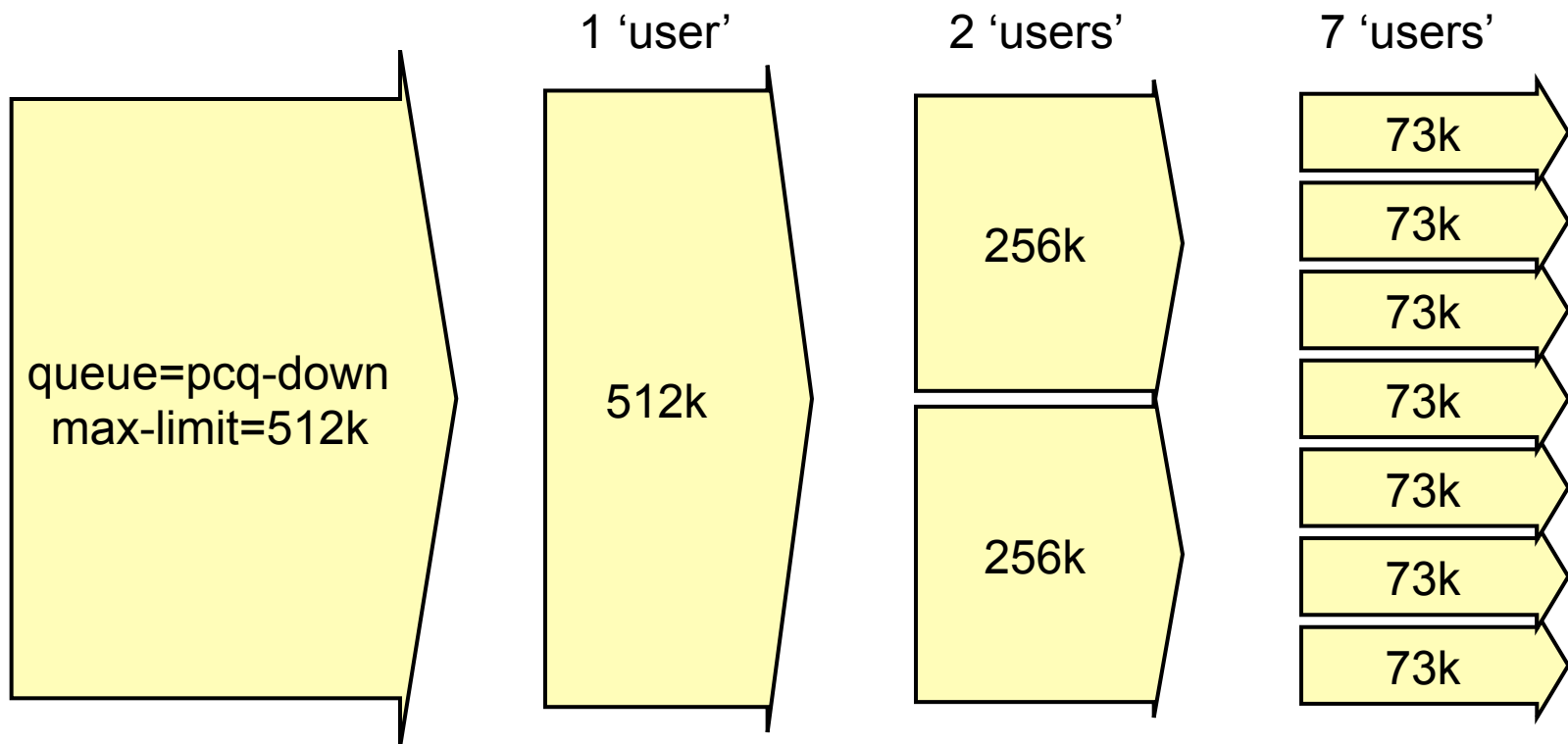

[LAB-4] Queue Kind - PCQ

Queue List

Simple Queues | Interface Queues | Queue Tree | **Queue Types**

+

Type Name	Kind
default	pfifo
default-small	pfifo
ethernet-default	pfifo
...	...

Queue Type <pcq-upload>

Type Name: **pcq-upload**

Kind: **pcq**

Rate: 128k

Limit: 50

Total Limit: 2000

- Classifier -

Src. Address Dst. Address

Src. Port Dst. Port

OK Cancel Apply Copy Remove

New Queue Type

Type Name: **pcq-download**

Kind: **pcq**

Rate: 128k

Limit: 50

Total Limit: 2000

- Classifier -

Src. Address **Dst. Address**

Src. Port Dst. Port

OK Cancel Apply Copy Remove

[LAB-4] Queue Kind - PCQ

New Simple Queue

General | Advanced | Statistics | Traffic | Total | Total Statistics

Name: limiter Network Client

Target Address: 192.168.x.0/24

Target Upload Target Download

Max Limit: 1M 1M

Burst

Burst Limit: unlimited unlimited

Burst Threshold: unlimited unlimited

Burst Time: 0 0

Time

New Simple Queue

General | Advanced | Statistics | Traffic | Total | Total Statistics

P2P: [v]

Packet Marks: [^]

Dst. Address: [v]

Interface: all [v]

Target Upload Target Download

Limit At: unlimited [v] unlimited [v] bits/s

Queue Type: pcq-upload [v] **pcq-download** [v]

Parent: none [v]

Priority: 8



Queue Tree & Mangle

- QueueTree adalah tool mikrotik yang memiliki kemampuan melimitasi bandwidth yang lebih lengkap dibandingkan dengan simple-queue.
- Dengan QueueTree memungkinkan untuk melakukan limitasi yang lebih fleksible karena supaya QueueTree bisa berfungsi maka harus menggunakan Mangle terlebih dahulu.



Mangle

- Mangle adalah cara untuk menandai paket-paket data tertentu, dan kita akan menggunakan tanda tersebut pada fitur lainnya, misalnya pada filter, routing, NAT, ataupun queue.
- Pada mangle kita juga bisa melakukan perubahan beberapa parameter pada IP Header, misalnya TOS (DSCP) dan TTL fields.
- Tanda mangle ini hanya bisa digunakan pada router yang sama, dan tidak terbaca pada router lainnya.
- Pembacaan rule mangle akan dilakukan dari atas ke bawah secara berurutan.

Mangle on Winbox - Example

Firewall

Filter Rules | Filter Chains | Source NAT | Destination NAT | **Mangle** | Ports | Connections

	Action	Src. Address	In. Inter...	Dst. Address	Proto...	Flow M...	Conne...	Bytes	Packets
::: INDORADIO									
	pass...	202.65.112.26/...	all	0.0.0.0/0	tcp		conn-in...	975030...	907428
	accept	0.0.0.0/0	all	0.0.0.0/0	all	flow-in...		101116...	1673186
	pass...	202.65.120.144...	Eth-B2...	0.0.0.0/0	icmp		mediat...	152406...	2919093
	accept	0.0.0.0/0	all	0.0.0.0/0	all	mediat...		597455...	5646401
::: Intersat									
X	accept	212.165.175.0/...	Eth-B2...	0.0.0.0/0	all	intersat...		0	0
::: /// Rule Added for ANGKASA UPLINK Network ///									
	accept	202.169.236.0/...	Eth-B2...	0.0.0.0/0	all			0	0
::: === UDP WSM DVB ===									
	pass...	0.0.0.0/0	Eth-CS...	0.0.0.0/0	udp		udp-ws...	613068...	26136052
	accept	0.0.0.0/0	all	0.0.0.0/0	all	udp-ws...		363646...	35526212
::: === UDP BTNAccess DVB ===									
	pass...	0.0.0.0/0	Eth-BT...	0.0.0.0/0	udp		udp-bt...	254292...	13087585
	accept	0.0.0.0/0	all	0.0.0.0/0	all	udp-bt...		117039...	21754579
::: JIX									
X	accept	202.162.32.0/20	all	0.0.0.0/0	all	jix-down		0	0
X	accept	202.95.156.0/22	all	0.0.0.0/0	all	jix-down		0	0
X	accept	202.169.224.0/...	all	0.0.0.0/0	all	jix-down		0	0
X	accept	202.159.120.0/...	all	0.0.0.0/0	all	jix-down		0	0
X	accept	202.69.103.0/27	all	0.0.0.0/0	all	jix-down		0	0
X	accept	202.174.136.0/...	all	0.0.0.0/0	all	jix-down		0	0

Chain pada mangle

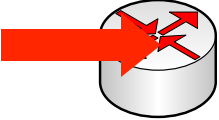
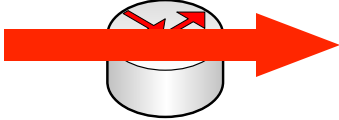
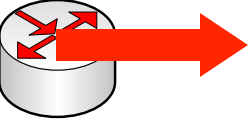
			
Prerouting	yes	yes	no
Input	yes	no	no
Forward	no	yes	no
Output	no	no	yes
Postrouting	no	yes	yes



Type of Mark

- Packet Mark
 - Penandaan untuk setiap paket data
- Connection Mark
 - Penandaan untuk koneksi
- Route Mark
 - Penandaan paket khusus untuk routing

Pada saat yang bersamaan, setiap paket data hanya bisa memiliki 1 conn-mark, 1 packet-mark, dan 1 route-mark



Connection Mark

- Adalah fitur mangle untuk menandai suatu koneksi (berlaku baik untuk request, maupun untuk response) sebagai satu kesatuan
- Untuk jaringan dengan src-nat atau kalau kita mau melakukan marking berdasarkan protokol tcp, disarankan untuk melakukan mark-connection terlebih dahulu, baru membuat mark-packet atau mark-routing berdasarkan conn-mark nya
- Mark-connection cukup dibuat pada saat proses request saja.



Passthrough

- Passthrough=no
 - berarti jika parameter sesuai, maka baris mangle berikutnya tidak lagi dibaca
 - value mangle sudah final, tidak diubah lagi
- Passthrough=yes
 - akan tetap membaca baris mangle berikutnya
 - value mangle bisa diubah lagi di baris berikutnya
- Biasanya pada :
 - mark-connection, passthrough = yes
 - mark-packet, passthrough=no

[LAB-5] QueueTree & Mangle

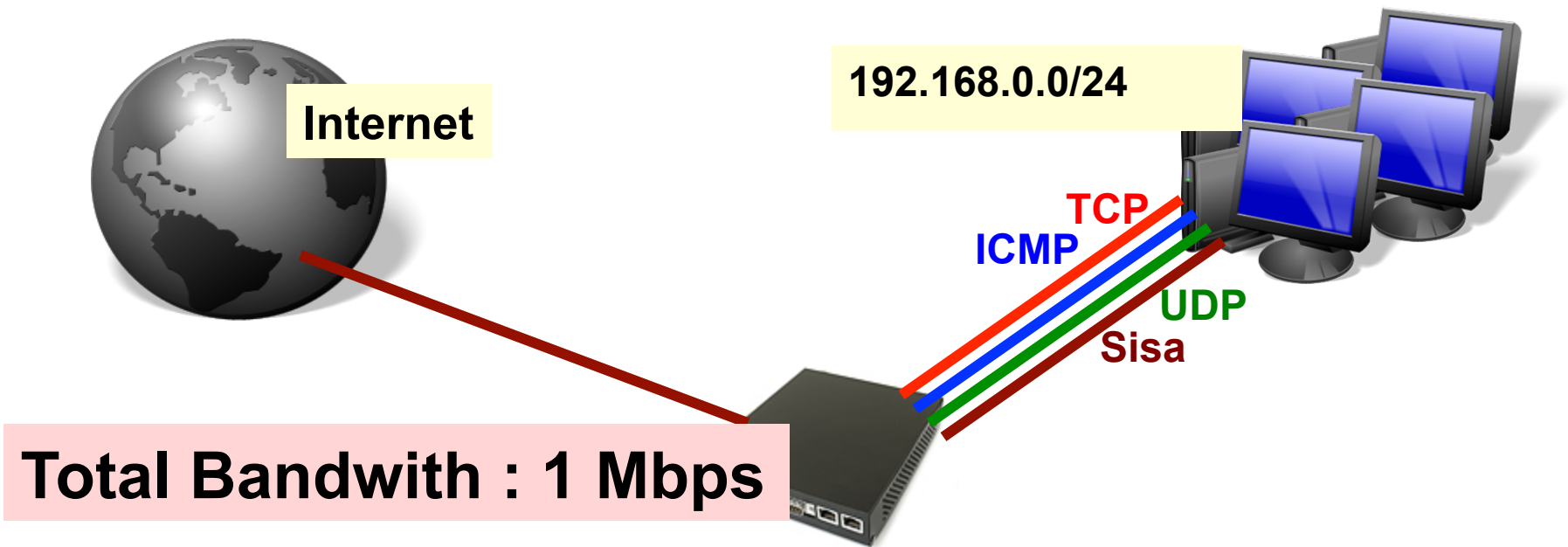

- Lakukan limitasi traffic dari client sekaligus dengan memisahkan type traffiknya.

Mark Connection - TCP

New Mangle Rule

General Advanced Extra Action Statistics

Chain:

Src. Address:

Dst. Address:

Protocol:

New Mangle Rule

General Advanced Extra Action Statistics

Action:

New Connection Mark:

Passthrough

Mark Packet – TCP

New Mangle Rule

General | Advanced | Extra | Action | Statistics

Chain:

Src. Address:

Dst. Address:

Protocol:

Src. Port:

Dst. Port:

Any. Port:

P2P:

In. Interface:

Out. Interface:

Packet Mark:

Connection Mark:

Mark Packet - TCP

New Mangle Rule

General

Advanced

Extra

Action

Statistics

Action: mark packet

New Packet Mark: packet-tcp

Passthrough

Mark Connection - UDP

New Mangle Rule

General Advanced Extra Action Statistics

Chain: forward

Src. Address: 192.168.x.0/24

Dst. Address:

Protocol: udp

New Mangle Rule

General Advanced Extra Action Statistics

Action: mark connection

New Connection Mark: conn-udp

Passthrough

Mark Packet - UDP

Mangle Rule <>

General | Advanced | Extra | Action | Statistics

Chain: forward

Src. Address:

Dst. Address:

Protocol:

Src. Port:

Dst. Port:

Any. Port:

P2P:

In. Interface:

Out. Interface:

Packet Mark:

Connection Mark: conn-udp

Mark Packet - UDP

Mangle Rule <>

General

Advanced

Extra

Action

Statistics

Action: mark packet

New Packet Mark: packet-udp

Passthrough

Mark Connection - ICMP

Mangle Rule <192.168.5.0/24>

General Advanced Extra Action Statistics

Chain: forward

Src. Address: 192.168.5.0/24

Dst. Address:

Protocol: 1 (icmp)

Mangle Rule <192.168.5.0/24>

General Advanced Extra Action Statistics

Action: mark connection

New Connection Mark: conn-icmp

Passthrough

Mark Packet - ICMP

New Mangle Rule

General | **Advanced** | Extra | Action | Statistics

Chain: forward

Src. Address:

Dst. Address:

Protocol:

Src. Port:

Dst. Port:

Any. Port:

P2P:

In. Interface:

Out. Interface:

Packet Mark:

Connection Mark: conn-icmp

Mark Packet - ICMP

New Mangle Rule

General Advanced Extra Action Statistics

Action: mark packet

New Packet Mark: packet-icmp

Passthrough

Mark Connection - Sisa

Mangle Rule <192.168.5.0/24>

General Advanced Extra Action Statistics

Chain: forward

Src. Address: 192.168.5.0/24

Mangle Rule <192.168.5.0/24>

General Advanced Extra Action Statistics

Action: mark connection

New Connection Mark: conn-sisa

Passthrough

Mark Packet - Sisa

Mangle Rule <>

General | Advanced | Extra | Action | Statistics

Chain: forward

Src. Address:

Dst. Address:

Protocol:

Src. Port:

Dst. Port:

Any. Port:

P2P:

In. Interface:

Out. Interface:

Packet Mark:

Connection Mark: conn-sisa

Mark Packet - Sisa

Mangle Rule <>

General Advanced Extra Action Statistics

Action: ▾

New Packet Mark: ▾

Passthrough

QueueTree – Parent

Queue <Total Download>

General

Statistics

Name: Total Download

Parent: ether1

Packet Marks:

Queue Type: default

Priority: 8

Limit At:

Max Limit: 1M

Queue <Total-Upload>

General

Statistics

Name: Total-Upload

Parent: wlan1

Packet Marks:

Queue Type: default

Priority: 8

Limit At:

Max Limit: 1M

bits/s

bits/s

QueueTree – Child TCP

Queue <Download-tcp>

General Statistics

Name:

Parent:

Packet Marks:

Queue Type:

Priority:

Limit At:

Max Limit:

Queue <Upload-tcp>

General Statistics

Name:

Parent:

Packet Marks:

Queue Type:

Priority:

Limit At:

▲ bits/s

Max Limit:

▲ bits/s

QueueTree – Child UDP

Queue <Download-udp>

General **Statistics**

Name:

Parent:

Packet Marks:

Queue Type:

Priority:

Limit At:

Max Limit:

Queue <Upload-udp>

General **Statistics**

Name:

Parent: ▼

Packet Marks: ▼ ▲

Queue Type: ▼

Priority:

Limit At: ▲ bits/s

Max Limit: ▲ bits/s

QueueTree – Child ICMP

Queue <Download-icmp>

General

Statistics

Name:

Parent:

Packet Marks:

Queue Type:

Priority:

Limit At:

Max Limit:

Queue <Upload-icmp>

General

Statistics

Name:

Parent:

Packet Marks:

Queue Type:

Priority:

Limit At:

Max Limit:

▲ bits/s

▲ bits/s

QueueTree – Child Sisa

Queue <Download-sisa>

General Statistics

Name:

Parent:

Packet Marks:

Queue Type:

Priority:

Limit At:

Max Limit:

Queue <Upload-sisa>

General Statistics

Name:

Parent: ▼

Packet Marks: ▼ ▲

Queue Type: ▼

Priority:







Limit At: ▲ bits/s











Max Limit: ▲ bits/s

QueueTree - Action

Queue List

Simple Queues Interface Queues Queue Tree Queue Types

	Name	Parent	Packet Marks	Limit At (bits/s)	Max Limit...	Avg. R...	Bytes	Packets
	Total Download	ether1			1M	781.9 ...	38.4 MiB	48 544
	Download-icmp	Total Download	packet-icmp	256k	1M	784 bps	134.7 KiB	1 402
	Download-sisa	Total Download	packet-sisa	256k	1M	0 bps	0 B	0
	Download-tcp	Total Download	packet-tcp	256k	1M	777.5 ...	36.1 MiB	33 788
	Download-udp	Total Download	packet-udp	256k	1M	28.4 k...	2211....	13 354
	Total-Upload	wlan1			1M	53.4 k...	4752....	37 919
	Upload-icmp	Total-Upload	packet-icmp	256k	1M	784 bps	129.3 KiB	1 357
	Upload-sisa	Total-Upload	packet-sisa	256k	1M	0 bps	0 B	0
	Upload-tcp	Total-Upload	packet-tcp	256k	1M	38.2 k...	3509....	22 737
	Upload-udp	Total-Upload	packet-udp	256k	1M	14.3 k...	1113....	13 825